

Symbol LS9203

Product Reference Guide

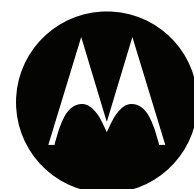
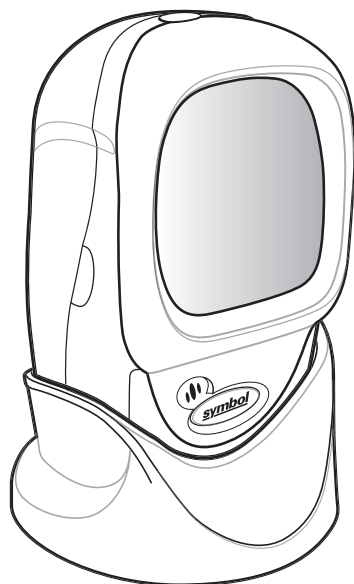

Symbol LS9203
Product Reference Guide

72E-71538-03

Revision A

February 2007



© Motorola, Inc. 2007. All rights reserved.

No part of this publication may be reproduced or used in any form, or by any electrical or mechanical means, without permission in writing from Motorola. This includes electronic or mechanical means, such as photocopying, recording, or information storage and retrieval systems. The material in this manual is subject to change without notice.

The software is provided strictly on an "as is" basis. All software, including firmware, furnished to the user is on a licensed basis. Motorola grants to the user a non-transferable and non-exclusive license to use each software or firmware program delivered hereunder (licensed program). Except as noted below, such license may not be assigned, sublicensed, or otherwise transferred by the user without prior written consent of Motorola. No right to copy a licensed program in whole or in part is granted, except as permitted under copyright law. The user shall not modify, merge, or incorporate any form or portion of a licensed program with other program material, create a derivative work from a licensed program, or use a licensed program in a network without written permission from Motorola. The user agrees to maintain Motorola's copyright notice on the licensed programs delivered hereunder, and to include the same on any authorized copies it makes, in whole or in part. The user agrees not to decompile, disassemble, decode, or reverse engineer any licensed program delivered to the user or any portion thereof.

Motorola reserves the right to make changes to any software or product to improve reliability, function, or design.

Motorola does not assume any product liability arising out of, or in connection with, the application or use of any product, circuit, or application described herein.

No license is granted, either expressly or by implication, estoppel, or otherwise under any Motorola intellectual property rights. An implied license only exists for equipment, circuits, and subsystems contained in Motorola products.

MOTOROLA and the Stylized M Logo are registered in the US Patent & Trademark Office. Symbol is a registered trademark of Symbol Technologies, Inc. All other product or service names are the property of their respective owners.

Motorola
One Symbol Plaza
Holtsville, New York 11742-1300
<http://www.symbol.com>

Revision History

Changes to the original manual are listed below:

Change	Date	Description
72E-71538-01	3/2005	Initial release.
72E-71538-02	10/2005	Update for additional Simple Comm Port Emulation bar code.
72E-71538-03	2/2007	Update service information, add parameter bar codes for Bookland ISBN, new UPC supplemental decode options, report software version

Contents

About This Guide

Introduction	xiii
Chapter Descriptions	xiii
Notational Conventions	xiii
Related Publications	xiv
Service Information	xiv

Chapter 1. Getting Started

Introduction	1-3
Unpacking the Scanner	1-3
Setting Up the Scanner	1-4
Installing the Interface Cable	1-4
Connecting Power (if required)	1-4
Configuring the Scanner	1-4
Removing the Interface Cable	1-5

Chapter 2. Scanning

Introduction	2-3
Scanning	2-3
Beeper Definitions	2-6
LED Definitions	2-7
Aiming	2-7
Decode Zone	2-8
Mounting Template	2-9

Chapter 3. Maintenance and Technical Specifications

Introduction.....	3-3
Maintenance.....	3-3
Troubleshooting.....	3-3
Technical Specifications.....	3-4
Scanner Signal Descriptions.....	3-6

Chapter 4. User Preferences

Introduction.....	4-3
Scanning Sequence Examples.....	4-3
Errors While Scanning.....	4-3
User Preferences Default Parameters.....	4-4
User Preferences.....	4-5
Set Default Parameter.....	4-5
Beeper Tone.....	4-6
Beeper Volume.....	4-8
Laser On Time.....	4-10
Beep After Good Decode.....	4-11
Timeout Between Decodes.....	4-12
Time Delay to Low Power Mode.....	4-13

Chapter 5. Keyboard Wedge Interface

Introduction.....	5-3
Connecting a Keyboard Wedge Interface.....	5-3
Keyboard Wedge Default Parameters.....	5-4
Keyboard Wedge Host Types.....	5-5
Keyboard Wedge Host Types.....	5-5
Keyboard Wedge Country Types (Country Codes).....	5-8
Ignore Unknown Characters.....	5-14
Keystroke Delay.....	5-15
Intra-Keystroke Delay.....	5-17
Alternate Numeric Keypad Emulation.....	5-18
Caps Lock On.....	5-19
Caps Lock Override.....	5-20
Convert Wedge Data.....	5-21
Function Key Mapping.....	5-23
FN1 Substitution.....	5-24
Send Make Break.....	5-25
Keyboard Maps.....	5-26
ASCII Character Set.....	5-28

Chapter 6. RS-232 Interface

Introduction.....	6-3
Connecting an RS-232 Interface.....	6-3
RS-232 Default Parameters.....	6-3
RS-232 Host Parameters.....	6-5

RS-232 Host Types	6-7
Baud Rate	6-11
Parity	6-15
Check Receive Errors	6-18
Hardware Handshaking	6-19
Software Handshaking	6-22
Host Serial Response Time-out	6-25
RTS Line State	6-28
Stop Bit Select	6-29
Data Bits	6-30
Beep on <BEL>	6-31
Intercharacter Delay	6-32
Nixdorf Beep/LED Options	6-35
Ignore Unknown Characters	6-37
ASCII / Character Set	6-38

Chapter 7. USB Interface

Introduction	7-3
Connecting a USB Interface	7-3
USB Default Parameters	7-4
USB Host Parameters	7-5
USB Device Type	7-5
USB Country Keyboard Types (Country Codes)	7-8
USB Keystroke Delay	7-14
USB CAPS Lock Override	7-16
USB Ignore Unknown Characters	7-17
Emulate Keypad	7-18
USB Keyboard FN1 Substitution	7-19
Function Key Mapping	7-20
Simulated Caps Lock	7-21
Convert Case	7-22
ASCII Character Set	7-24

Chapter 8. Wand Emulation Interface

Introduction	8-3
Connecting Using Wand Emulation	8-3
Wand Emulation Default Parameters	8-4
Wand Emulation Host Parameters	8-5
Wand Emulation Host Types	8-5
Leading Margin (Quiet Zone)	8-7
Polarity	8-9
Ignore Unknown Characters	8-10
Convert All Bar Codes to Code 39	8-11
Convert Code 39 to Full ASCII	8-12

Chapter 9. Symbologies

Introduction	9-5
Scanning Sequence Examples	9-5
Errors While Scanning	9-5
Symbology Default Parameters	9-6
UPC/EAN	9-9
Enable/Disable UPC-A/UPC-E	9-9
Enable/Disable UPC-E1	9-11
Enable/Disable EAN-13/JAN-13/EAN-8/JAN-8	9-12
Enable/Disable Bookland EAN	9-14
Decode UPC/EAN Supplementals	9-15
UPC/EAN Supplemental Redundancy	9-24
Transmit UPC-A/UPC-E/UPC-E1 Check Digit	9-25
UPC-A Preamble	9-28
UPC-E Preamble	9-30
UPC-E1 Preamble	9-32
Convert UPC-E to UPC-A	9-34
Convert UPC-E1 to UPC-A	9-35
EAN Zero Extend	9-36
Bookland ISBN Format	9-37
UCC Coupon Extended Code	9-38
Linear UPC/EAN Decode	9-39
Code 128	9-40
Enable/Disable Code 128	9-40
Enable/Disable UCC/EAN-128	9-41
Enable/Disable ISBT 128	9-42
Code 128 Decode Performance	9-43
Code 128 Decode Performance Level	9-44
Code 39	9-46
Enable/Disable Code 39	9-46
Enable/Disable Trioptic Code 39	9-47
Convert Code 39 to Code 32	9-48
Code 32 Prefix	9-49
Set Lengths for Code 39	9-50
Code 39 Check Digit Verification	9-52
Transmit Code 39 Check Digit	9-53
Enable/Disable Code 39 Full ASCII	9-54
Code 39 Buffering (Scan & Store)	9-55
Code 39 Decode Performance	9-58
Code 39 Decode Performance Level	9-59
Code 93	9-61
Enable/Disable Code 93	9-61
Set Lengths for Code 93	9-62
Code 11	9-64
Code 11	9-64
Set Lengths for Code 11	9-65

Code 11 Check Digit Verification	9-67
Transmit Code 11 Check Digits	9-69
Interleaved 2 of 5 (ITF)	9-70
Enable/Disable Interleaved 2 of 5	9-70
Set Lengths for Interleaved 2 of 5	9-71
I 2 of 5 Check Digit Verification	9-73
Transmit I 2 of 5 Check Digit	9-75
Convert I 2 of 5 to EAN-13	9-76
Discrete 2 of 5 (DTF)	9-77
Enable/Disable Discrete 2 of 5	9-77
Set Lengths for Discrete 2 of 5	9-78
Chinese 2 of 5	9-80
Enable/Disable Chinese 2 of 5	9-80
Codabar (NW - 7)	9-81
Enable/Disable Codabar	9-81
Set Lengths for Codabar	9-82
CLSI Editing	9-84
NOTIS Editing	9-85
MSI	9-86
Enable/Disable MSI	9-86
Set Lengths for MSI	9-87
MSI Check Digits	9-89
Transmit MSI Check Digit(s)	9-90
MSI Check Digit Algorithm	9-91
RSS (Reduced Space Symbology)	9-92
RSS 14	9-92
RSS Limited	9-93
RSS Expanded	9-94
Convert RSS to UPC/EAN	9-95
Symbology - Specific Security Levels	9-97
Redundancy Level	9-97
Security Level	9-99
Symbology - Intercharacter Gap	9-101

Chapter 10. Miscellaneous Scanner Options

Introduction	10-3
Scanning Sequence Examples	10-3
Errors While Scanning	10-3
Miscellaneous Default Parameters	10-3
Miscellaneous Scanner Parameters	10-4
Transmit Code ID Character	10-4
Prefix/Suffix Values	10-6
FN1 Substitution Values	10-9
Scan Data Transmission Format	10-10
Transmit "No Read" Message	10-14
Report Version	10-15

Appendix A. Standard Default Parameters

Appendix B. Programming Reference

Symbol Code Identifiers	B-3
AIM Code Identifiers	B-4

Appendix C. Sample Bar Codes

Code 39	C-3
UPC/EAN	C-3
UPC-A, 100%	C-3
EAN-13, 100%	C-3
Code 128	C-4
Interleaved 2 of 5	C-4
RSS 14	C-4

Appendix D. Numeric Bar Codes

0, 1	D-3
2, 3	D-4
4, 5	D-5
6, 7	D-6
8, 9	D-7
Cancel	D-8

Glossary

Index

Tell Us What You Think...

About This Guide

Chapter Contents

Introduction	xiii
Chapter Descriptions	xiii
Notational Conventions	xiii
Related Publications	xiv
Service Information	xiv

Introduction

The *Symbol LS9203 Product Reference Guide* provides general instructions for setting up, operating, maintaining and troubleshooting the Symbol LS9203 scanner.

Chapter Descriptions

- [Chapter 1, Getting Started](#) provides a product overview and unpacking instructions.
- [Chapter 2, Scanning](#) describes parts of the scanner, beeper and LED definitions, how to use the scanner in hand-held and hands-free modes.
- [Chapter 3, Maintenance and Technical Specifications](#) provides information on how to care for the scanner, troubleshooting, and technical specifications.
- [Chapter 4, User Preferences](#) provides the programming bar codes necessary for selecting user preference features for the scanner.
- [Chapter 5, Keyboard Wedge Interface](#) covers information for setting up the scanner for Keyboard Wedge operation.
- [Chapter 6, RS-232 Interface](#) covers information for setting up the scanner for RS-232 operation.
- [Chapter 7, USB Interface](#) covers information for setting up the scanner for USB operation.
- [Chapter 8, Wand Emulation Interface](#) covers all information for setting up the scanner for Wand emulation operation.
- [Chapter 9, Symbologies](#) describes all symbology features and provides the programming bar codes necessary for selecting these features for the scanner.
- [Chapter 10, Miscellaneous Scanner Options](#) includes commonly used bar codes to customize how the data is transmitted to the host device.
- [Chapter A, Standard Default Parameters](#) provides a table of all host devices and miscellaneous scanner defaults.
- [Chapter B, Programming Reference](#) provides a table of AIM code identifiers, ASCII character conversions, and keyboard maps.
- [Chapter C, Sample Bar Codes](#) includes sample bar codes.
- [Chapter D, Numeric Bar Codes](#) includes the numeric bar codes to scan for parameters requiring specific numeric values.

Notational Conventions

The following conventions are used in this document:

- Bullets (●) indicate:
 - action items
 - lists of alternatives
 - lists of required steps that are not necessarily sequential
- Sequential lists (e.g., those that describe step-by-step procedures) appear as numbered lists.
- Throughout the programming bar code menus, asterisks (*) are used to denote default parameter settings.

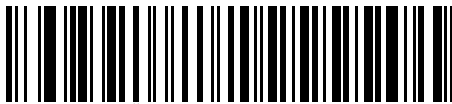

* Indicates Default *Baud Rate 9600 Feature/Option

Related Publications

The *LS9203 Quick Start Guide*, p/n 72-71576-01, provides general information to help the user get started with the scanner. It includes basic set-up and operation instructions.

The *Advanced Data Formatting Programmer Guide*, p/n 72-69680-01, provides bar codes that allow the user to perform advanced programming of a Motorola scanner, and instructions for using them. provides general information to help the user get started with the scanner. It includes basic set-up and operation instructions.

For the latest versions go to: <http://www.symbol.com/manuals>.

Service Information

If there is a problem with the equipment, contact the regional Global Customer Interaction Center. For contact number information, visit: www.symbol.com/contactsupport for a Customer Interaction Center in your area. Before calling, have the model number, serial number and several bar code symbols at hand.

Call the Global Customer Interaction Center from a phone near the scanning equipment so that the service person can try to troubleshoot the problem. If the equipment is found to be working properly and the problem is reading bar codes, the Support Center will request samples of the bar codes for analysis at our plant.

If the problem cannot be solved over the phone, it may be necessary to return the equipment for servicing. If that is necessary, the Global Customer Interaction Center will provide specific directions.



Motorola is not responsible for any damages incurred during shipment if the approved shipping container is not used. Shipping the units improperly can possibly void the warranty. If the original shipping container was not kept, contact Motorola to have another sent.

If the product was purchased from a Motorola Business Partner, contact that Business Partner for service.

1

Getting Started

Chapter Contents

Introduction	1-3
Unpacking the Scanner	1-3
Setting Up the Scanner	1-4
Installing the Interface Cable	1-4
Connecting Power (if required)	1-4
Configuring the Scanner	1-4
Removing the Interface Cable	1-5

Introduction

The Symbol LS9203 is a high value, omnidirectional presentation scanner, offering performance and reliability in a compact design built to fit into virtually any POS environment. The Symbol LS9203 can be used as a presentation scanner or hand-held for added versatility. The integrated lightweight stand can be left attached or secured to a table top.

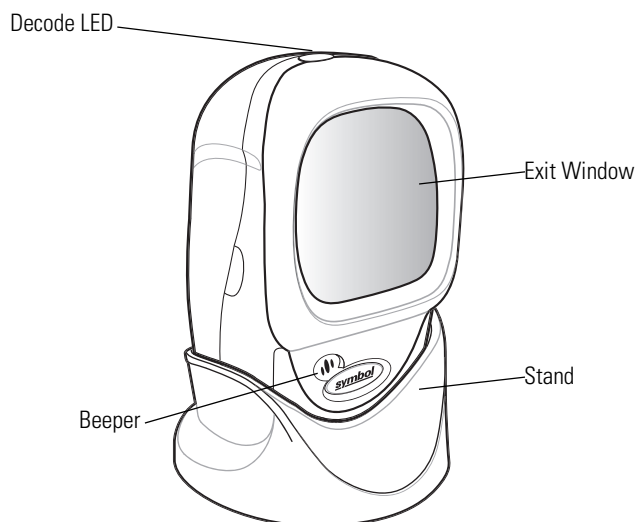

Figure 1-1. Symbol LS9203 Scanner

The Symbol LS9203 scanner supports the following interfaces:

- Standard RS-232 connection to a host. Proper communications of the scanner with the host is set up by scanning bar code menus.
- Keyboard Wedge connection to a host. Scanned data is interpreted by the host as keystrokes.
 - International Keyboards supported (for Windows® environment): North American, German, French, Spanish, Italian, Swedish, UK English, Brazilian/Portuguese and Japanese.
 - International Keyboards supported (for Win XP/2000™ environment): French Canadian
 - International Keyboards supported (for Win 95/98 environment): French Canadian
- Wand Emulation connection to a host. The scanner is connected to a portable data terminal, a controller, or host which collects the data as wand data and decodes it.
- USB connection to a host. The scanner autodetects a USB host and defaults to the HID keyboard interface type. Other USB interface types are selectable by scanning programming bar code menus.
 - International Keyboards supported (for Windows environment): North America, German, French, French International, Spanish, Italian, Swedish, British, and Japanese.

Unpacking the Scanner

Remove the scanner from its packing and inspect it for damage. If the scanner was damaged in transit, call the Global Customer Interaction Center. See [page xiv](#) for contact information. **KEEP THE PACKING.** It is the approved shipping container and should be used if the equipment is returned for servicing.

Setting Up the Scanner

Installing the Interface Cable

1. Connect the interface cable to the host computer.
2. Plug the interface cable modular connector into the interface cable port on the rear of the Symbol LS9203 (See [Figure 1-2.](#))
3. Push the connector into the housing until a “click” sound is heard. *The green LED lights up and three short high beeps sound, indicating that the scanner is operational.*

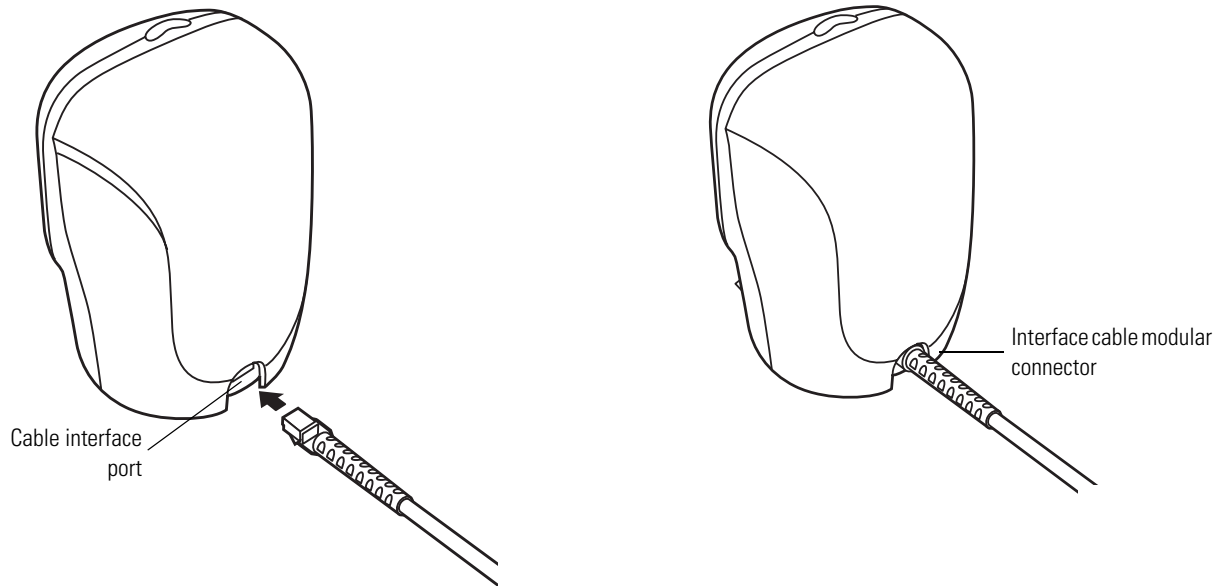

Figure 1-2. Installing the Interface Cable



Note

Different cables are required for different hosts. The connectors illustrated in each host chapter are examples only. The connectors may be different than those illustrated, but the steps to connect the scanner remain the same.

Connecting Power (if required)

If the host does not provide power to the scanner, an external power connection to the scanner is required:

1. Connect the interface cable to the back of the scanner, as described in [Installing the Interface Cable on page 1-4.](#)
2. Connect the other end of the interface cable to the host (refer to the host manual to locate the correct port).
3. Plug the power supply into the power jack on the interface cable.
4. Plug the other end of the power supply into an AC outlet.

Configuring the Scanner

To configure the scanner, use the bar codes included in this manual. Refer to [Chapter 4, User Preferences](#) for information about programming the scanner using bar code menus.

The scanner supports RS-232, Keyboard Wedge, Wand Emulation and USB to interface to a host system. Each host specific chapter describes how to set up each of these connections.

Removing the Interface Cable

To remove the interface cable:

1. Unplug the installed cable's modular connector by depressing the connector clip and gently pulling back.
2. Follow the steps for [Installing the Interface Cable on page 1-4](#) to connect a new cable.

2

Scanning

Chapter Contents

Introduction	2-3
Scanning in Omni Mode	2-4
Beeper Definitions	2-7
LED Definitions	2-9
Aiming	2-9
Decode Zone	2-10
Mounting Template	2-11

Introduction

This chapter covers the techniques involved in scanning bar codes, beeper and LED definitions, and general instructions and tips about scanning.

Scanning

An omni scan pattern provides rapid, orientation-free scanning. Scanning can be done as either a hands-free or hand-held operation.

To scan a bar code, direct it in toward the window of the scanner (“presentation” scanning, see [Figure 2-4 on page 2-5](#)) or from side to side in a sweeping motion (“swipe” scanning, see [Figure 2-5 on page 2-5](#)).

1. Ensure all cable connections are secure.
2. Place the scanner in the stand (see [Figure 2-1](#)).

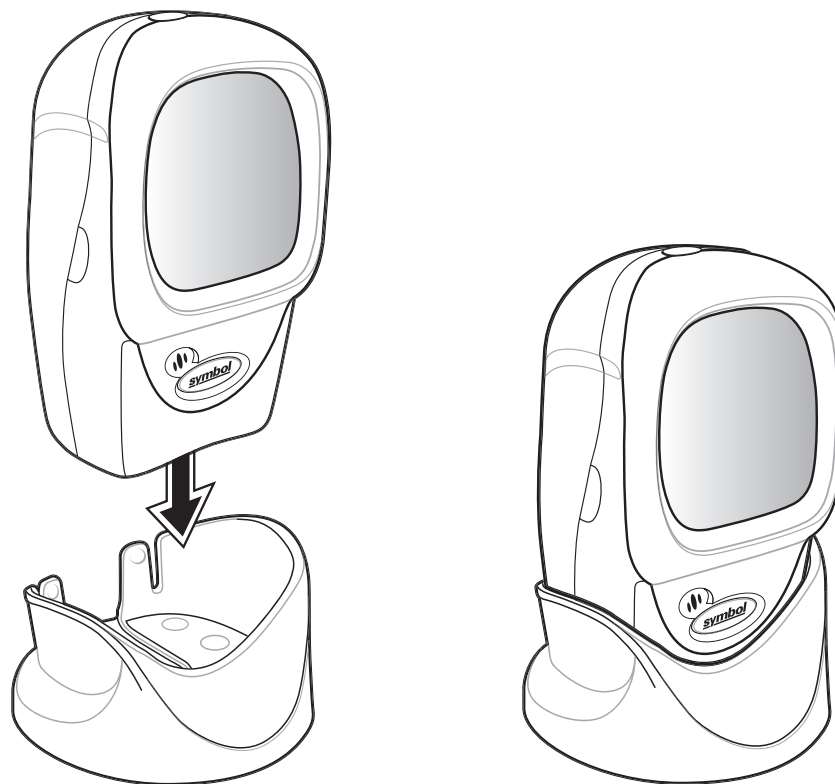

Figure 2-1. Scanner in the Stand

To mount the detachable stand, see [Mounting Template on page 2-9](#).

3. To scan a bar code, present the bar code and ensure the scan lines cross every bar and space of the symbol. See [Figure 2-2 on page 2-4](#) for scanning in hands-free mode and [Figure 2-3 on page 2-4](#) for scanning in hand-held mode.
4. Upon successful decode, the scanner beeps and the green LED flashes momentarily.

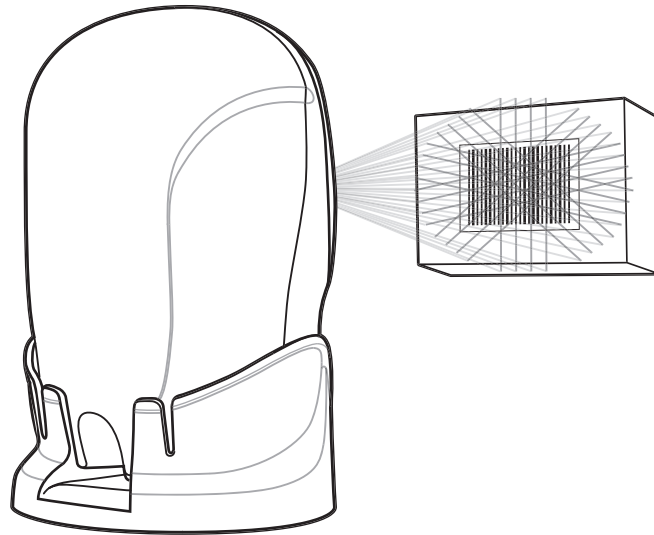

Figure 2-2. Hands-Free Mode

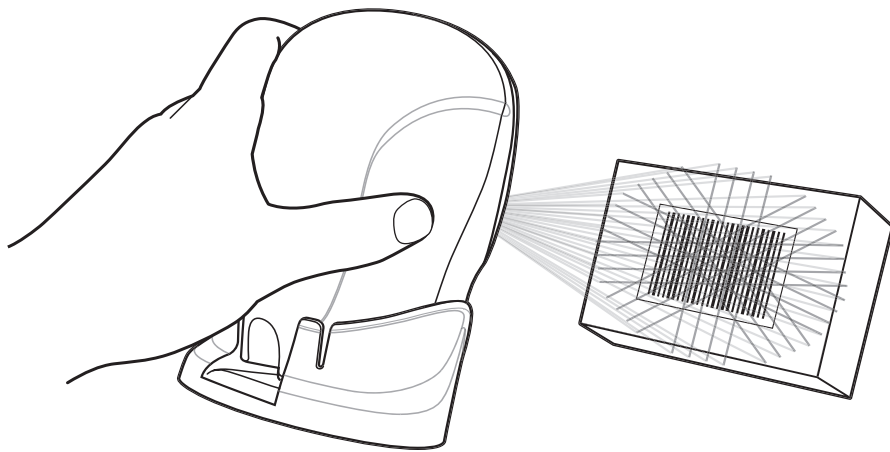

Figure 2-3. Hand-Held Mode

To scan a bar code, present it to the exit window of the scanner ("presentation" scanning) or move it from side-to-side in a sweeping motion ("swipe" scanning) as shown in [Figure 2-4](#) and [Figure 2-5](#).

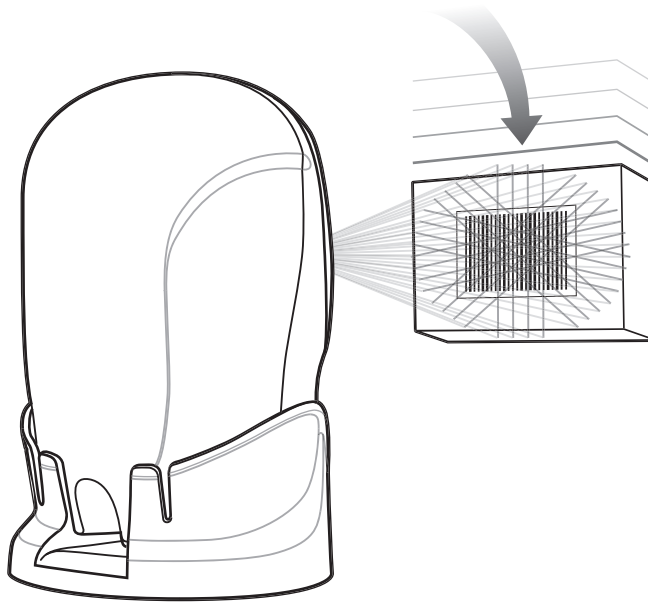

Figure 2-4. "Presentation" scanning

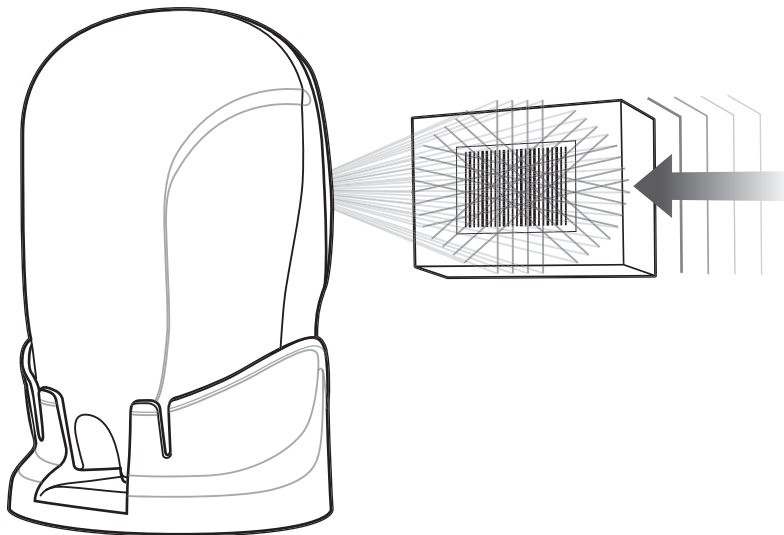

Figure 2-5. "Swipe" scanning

Beeper Definitions

The scanner communicates with the user by emitting different beeper sequences and patterns. Table 2-1 defines beep sequences that occur during both normal scanning and while programming the scanner.

Table 2-1. Standard Beeper Definitions

Beeper Sequence	Indication
Standard Use	
3 short high beeps	Power up.
Short high beep	A bar code symbol was decoded (if decode beeper is enabled).
4 long low beeps	A transmission error was detected in a scanned symbol. The data is ignored. This occurs if a unit is not properly configured. Check option setting.
5 low beeps	Conversion or format error.
Lo/hi/lo beep	ADF transmit error.
Hi/hi/hi/lo beep	RS-232 receive error.
Parameter Menu Scanning	
Short high beep	Correct entry scanned or correct menu sequence performed.
Lo/hi beep	Input error, incorrect bar code or "Cancel" scanned, wrong entry, incorrect bar code programming sequence; remain in program mode.
Hi/lo beep	Keyboard parameter selected. Enter value using bar code keypad.
Hi/lo/hi/lo beep	Successful program exit with change in the parameter setting.
Low/hi/low/hi beep	Out of host parameter storage space. Scan Set Default Parameter on page 4-5 .
Code 39 Buffering	
Hi/lo beep	New Code 39 data was entered into the buffer.
3 long high beeps	Code 39 buffer is full.
Lo/hi/lo beep	The Code 39 buffer was erased or there was an attempt to clear or transmit an empty buffer.
Lo/hi beep	A successful transmission of buffered data.
Host Specific	
USB only	
4 short high beeps	Scanner has not completed initialization. Wait several seconds and scan again.
Scanner gives a power-up beep after scanning a USB Device Type.	Communication with the bus must be established before the scanner can operate at the highest power level.
This power-up beep occurs more than once.	The USB bus may put the scanner in a state where power to the scanner is cycled on and off more than once. This is normal and usually happens when the PC cold boots.
RS-232 only	
1 short high beep	A <BEL> character is received and Beep on <BEL> is enabled.

LED Definitions

In addition to beeper sequences, the scanner communicates with the user using an LED display. Table 2-2 defines LED flashes that display during scanning.

Table 2-2. Standard LED Definitions

LED	Indication
Off	No power is applied to the scanner.
Green	The scanner is on and "ready to scan."
Momentary flash	A bar code was successfully decoded.
Slow continuous flashing	The scanner is in programming mode.
Fast continuous flashing	There is a internal problem; the laser is shut off for regulatory reasons.

Aiming

Do not hold the scanner directly over the bar code. Laser light reflecting *directly* back into the scanner from the bar code is known as specular reflection. This specular reflection can make decoding difficult.

The scanner can be tilted up to 45° forward or back and achieve a successful decode (Figure 2-6). Simple practice quickly shows what tolerances to work within.

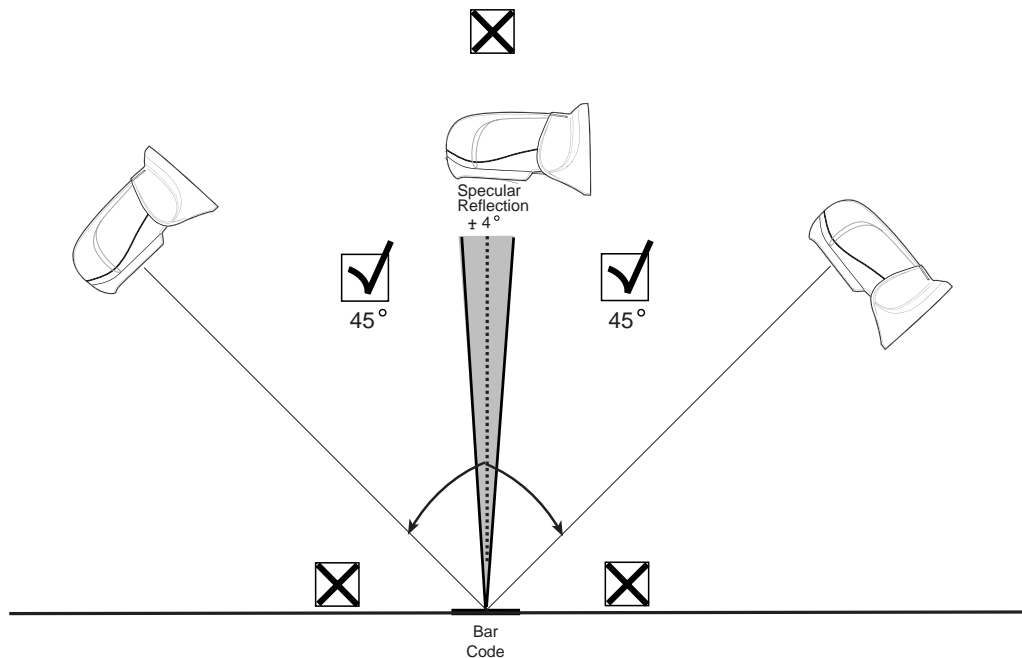
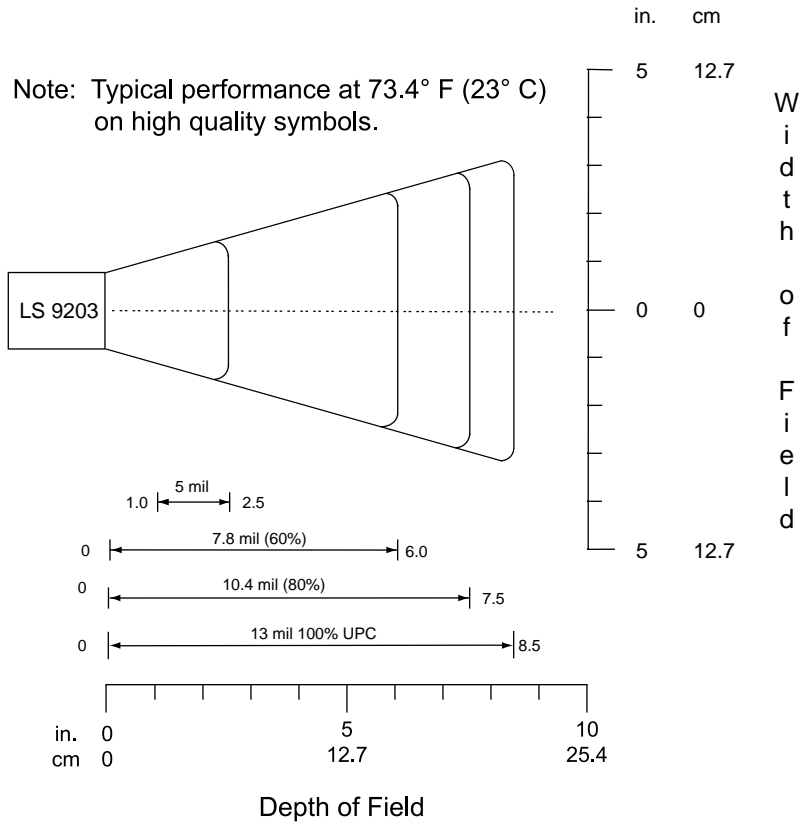

Figure 2-6. Maximum Tilt Angles and Dead Zone

Decode Zone



*Minimum distance determined by symbol length and scan angle

Figure 2-7. Symbol LS9203 Decode Zone

Mounting Template

Use the template to mount the optional hands-free stand on a flat surface. Two #6-32 screws, 5/8 in. long, are recommended.

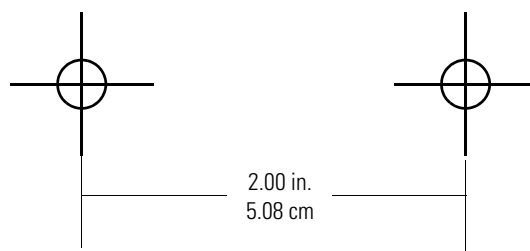

Figure 2-8. Detachable Stand Mounting Template

3

Maintenance and Technical Specifications

Chapter Contents

Introduction	3-3
Maintenance	3-3
Troubleshooting	3-3
Technical Specifications	3-4
Scanner Signal Descriptions	3-6

Introduction

This chapter covers suggested scanner maintenance, troubleshooting, technical specifications, and signal descriptions (pinouts).

Maintenance

Cleaning the exit window is the only maintenance required. A dirty window may affect scanning accuracy.

- Do not allow any abrasive material to touch the window.
- Remove any dirt particles with a damp cloth.
- Wipe the window using a tissue moistened with ammonia/water.
- Do not spray water or other cleaning liquids directly into the window.

Troubleshooting

Problem	Possible Causes	Possible Solutions
The omni-line scan pattern does not display when the directions are followed for installing the interface cable on 1-4.	No power to the scanner.	Ensure the host has power, and is on. If the scanner uses a separate power supply, ensure it's connected to a working AC outlet.
	Interface cable is not properly connected.	Check for loose cable connections.
Scan line(s) display, but bar code cannot be read.	Scanner is not programmed to read the bar code type.	Ensure scanner is programmed to read the bar code type being scanned.
	Bar code is damaged.	Try scanning other bar codes of the same bar code type.
	Bar code is too far from scanner.	Move the bar code closer to the scanner.
	The host has disabled scanning or overridden parameter settings.	See the technical person in charge of scanning.
Bar code is decoded, but not transmitted to the host.	Scanner is not programmed for the correct host type.	Scan the appropriate host type bar code.
Scanned data is incorrectly displayed on the host.	Scanner is not programmed to work with the host. Check scanner host type parameters or editing options.	Ensure proper host is selected. For RS-232, ensure the scanner's communication parameters match the host's settings. For keyboard wedge, ensure scanner is programmed with the correct country code and that the CAPS LOCK key is off. Ensure editing options (e.g., UPCE-to-UPCA Conversion) are properly programmed.



If after performing these checks the symbol still does not scan, contact the distributor or call the local Global Customer Interaction Center. See [page xiv](#) for contact information.

Technical Specifications

Table 3-1. Technical Specifications

Item	Description
Physical Characteristics	
Dimensions:	
without stand:	
Height	5.51 in. (14 cm)
Width	3.49 in. (8.8 cm)
Depth	2.96 in. (7.5 cm)
with stand:	
Height	6.15 in. (15.62 cm)
Width	3.87 in. (9.83 cm)
Depth	3.95 in. (10.03 cm)
Weight	Scanner only: 9.9 oz/282 g With stand: 12.2 oz/379 g
Power Source	Power drawn from host or external power supply; depends on host type.
Voltage	5.0 VDC \pm 10%
Nominal Current	275 mA
Power	2 watts
Mounting Options	Fixed-mount stand
Color	Twilight Black
Performance Characteristics	
Light Source	650nm visible laser diode
Yaw Tolerance (Typical)^{Note 1}	Omnidirectional: \pm 50°
Pitch Tolerance (Typical)^{Note 1}	Omnidirectional: \pm 50°
Roll Tolerance (Typical)^{Note 1}	Omnidirectional: 0 to 360°
Print Contrast	25% minimum reflective difference
Scan Patterns	Omnidirectional: 20 interlocking lines
Scan Rate	Omnidirectional: 1500 scans/second
Depth of Field	0 to 8.5 in./0 to 21.6 cm @ 13 mil (100% UPC/EAN)
Nominal Working Range	5 mil: (38%) 1 to 2.5 in./ 2.5 to 6.4 cm 7.8 mil: (60%) 0 to 6 in./ 0 to 15.2 cm 10.4 mil: (80%) 0 to 7.5 in./ 0 to 19 cm 13 mil: (100%) 0 to 8.5 in./ 0 to 21.6 cm
Width of Field	1.6 in. (40 mm) @ Face 6.7 in. (170 mm) @ 9 in.
Minimum Resolution	5 mil
Decode Capability	UPC/EAN/JAN, UPC/EAN with Supplementals, UCC/ EAN 128, Code 128, ISBT 128, Code 39, Code 39 Trioptic, Chinese 2 of 5, Interleaved 2 of 5, Discrete 2 of 5, Code 93, Code 11, Codabar, MSI, RSS Variants
Interfaces Supported	USB, RS 232, Keyboard Wedge and Wand
¹ Refers to 100% UPC bar code (80% contrast) located 4 in./10 cm from the scanner nose.	

Table 3-1. Technical Specifications (Continued)

Item	Description
User Environment	
Operating Temperature	32° to 104°F (0° to 40°C)
Storage Temperature	-40° to 158°F (-40° to 70°C)
Humidity	5% to 95% (non-condensing)
Drop Specifications	Designed to withstand 4 ft. (1.2 m) drops.
Ambient Light Immunity	Immune to normal artificial indoor and natural outdoor (direct sunlight) lighting conditions. Fluorescent, Incandescent, Mercury Vapor and Sodium Vapor: 450 Ft Candles (4,844 Lux) Sunlight: 8000 Ft Candles (86,111 Lux)
Regulatory	
Electrical Safety	Certified to UL 1950, CSA C22.2 No. 950
Laser Safety	CDRH Class IIa Laser Product IEC 60825 Class 1 Laser Product
EMC	CISPR B, FCC B
¹ Refers to 100% UPC bar code (80% contrast) located 4 in./10 cm from the scanner nose.	

Scanner Signal Descriptions

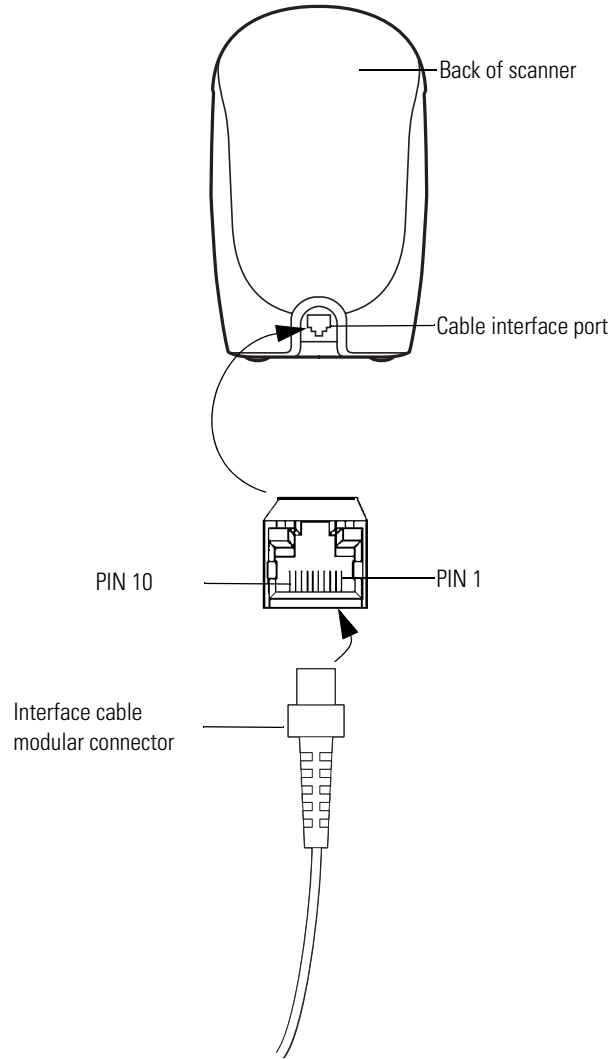

Figure 3-1. Scanner Cable Pinouts

The signal descriptions in [Table 3-2](#) apply to the connector on the scanner and are for reference only.

Table 3-2. Scanner Signal Pin-outs

Pin	Symbol LS9203			
	RS-232	Keyboard Wedge	Wand	USB
1	Reserved	Reserved	Reserved	Jump to Pin 6
2	Power	Power	Power	Power
3	Ground	Ground	Ground	Ground
4	TxD	KeyClock	DBP	Reserved
5	RxD	TermData	CTS	D +
6	RTS	KeyData	RTS	Jump to Pin 1
7	CTS	TermClock	Reserved	D -
8	Reserved	Reserved	Reserved	Reserved
9	Reserved	Reserved	Reserved	Reserved
10	Reserved	Reserved	Reserved	Reserved

4

User Preferences

Chapter Contents

Introduction	4-3
Scanning Sequence Examples	4-3
Errors While Scanning	4-3
User Preferences Default Parameters	4-4
User Preferences	4-5
Set Default Parameter	4-5
Beeper Tone	4-6
Beeper Volume	4-8
Laser On Time	4-10
Beep After Good Decode	4-11
Timeout Between Decodes	4-12
Time Delay to Low Power Mode	4-13

Introduction

The Symbol LS9203 scanner can be programmed to perform various functions, or activate different features. This chapter describes each user preference feature and provides the programming bar codes necessary for selecting these features for the Symbol LS9203 scanner. Before programming, follow the instructions in [Chapter 1, Getting Started](#).

The Symbol LS9203 is shipped with the settings shown in the [User Preferences Default Table on page 4-4](#) (also see [Chapter A, Standard Default Parameters](#) for all host device and miscellaneous scanner defaults). Programming may not be necessary if the default values all requirements.

Features values are set by scanning single bar codes or short bar code sequences. The settings are stored in non-volatile memory and are preserved even when the scanner is powered down.

If not using a USB cable, select a host type (see each host chapter for specific host information). After hearing the power-up beeps, select a host type. This only needs to be done once, upon the first power-up when connected to a new host.

To return all features to their default values, scan the [Set All Defaults bar code on page 4-5](#). Throughout the programming bar code menus, default values are indicated with asterisks (*).



* Indicates Default ——— *High Frequency ——— Feature/Option

Scanning Sequence Examples

In most cases it is required to only scan one bar code to set a specific parameter value. For example, to set the beeper tone to high, simply scan the High Frequency (beeper tone) bar code listed under [Beeper Tone on page 4-6](#). The scanner issues a short high beep and the LED turns green, signifying a successful parameter entry.

Other parameters, such as specifying Serial Response Time-Out or setting Data Transmission Formats, require scanning several bar codes. Refer to [Host Serial Response Time-out on page 6-25](#) and [Scan Data Transmission Format on page 10-10](#) for descriptions of this procedure.

Errors While Scanning

Unless otherwise specified, if an error is made during a scanning sequence, just re-scan the correct parameter.

User Preferences Default Parameters

Table 4-1 lists the defaults for user preferences parameters. To change any option, scan the appropriate bar code(s) provided in the User Preferences section beginning on page 4-5.



See *Chapter A, Standard Default Parameters* for all user preferences, hosts, symbologies, and miscellaneous default parameters.

Table 4-1. User Preferences Default Table

Parameter	Default	Page Number
User Preferences		
Set Default Parameter	All Defaults	4-5
Beeper Tone	High	4-7
Beeper Volume	High	4-9
Laser On Time	3.0 Sec	4-10
Beep After Good Decode	Enable	4-11
Time-out Between Same Symbol	0.6 sec	4-12
Time-out Between Different Symbols	0.2 sec	4-12
Time Delay to Low Power Mode	30 Minutes	4-13

User Preferences

Set Default Parameter

Scanning this bar code returns all parameters to the default values listed in [Table A-1 on page A-1](#).

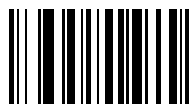

Set All Defaults

Beeper Tone

To select a decode beep frequency (tone), scan the **Low Frequency**, **Medium Frequency**, or **High Frequency** bar code.

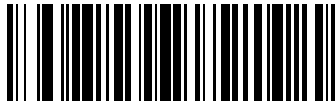

Low Frequency

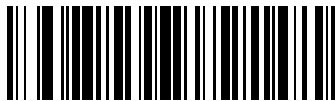

Medium Frequency

Beeper Tone (Continued)

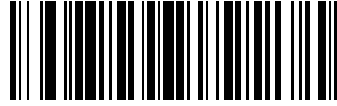

***High Frequency**

Beeper Volume

To select a beeper volume, scan the **Low Volume**, **Medium Volume**, or **High Volume** bar code.



Low Volume



Medium Volume

Beeper Volume (Continued)



***High Volume**

Laser On Time

This parameter sets the maximum time that decode processing continues during a scan attempt. It is programmable in 0.1 second increments from 0.5 to 10 seconds. The default Laser On Time is 3.0 seconds.

To set a Laser On Time, scan the bar code below. Next, scan two numeric bar codes beginning on page [D-1](#) in [D](#) that correspond to the desired on time. Single digit numbers must have a leading zero. For example, to set an On Time of 0.5 seconds, scan the bar code below, then scan the "0" and "5" bar codes. If an error is made, or to change a selection, scan **Cancel** on page [D-8](#).



Laser On Time

Beep After Good Decode

Scan a bar code below to select whether or not the scanner beeps after a good decode. If **Do Not Beep After Good Decode** is selected, the beeper still operates during parameter menu scanning and indicates error conditions.



***Beep After Good Decode
(Enable)**



**Do Not Beep After Good Decode
(Disable)**

Timeout Between Decodes

Timeout Between Decodes, Same Symbol

This parameter sets the minimum time between decodes of different symbols. It is programmable in 0.1-second increments from 0.0 to 9.9 seconds. Setting this above 0.4 seconds is recommended.) The default for this parameter is 0.6 seconds.

Scan the bar code below to select a new timeout. Next, scan two numeric bar codes beginning in [Numeric Bar Codes on page D-1](#) that correspond to the desired timeout. Single digit numbers must have a leading zero. For example, to set a timeout of 0.5 seconds, scan the bar code below, then scan the "0" and "5" bar codes. If an error is made, or to change a selection, scan [Cancel on page D-8](#).



Timeout Between Same Symbol

Timeout Between Decodes, Different Symbol

This parameter sets the minimum time between decodes of different symbols. It is programmable in 0.1-second increments from 0.0 to 9.9 seconds. The default for this parameter is 0.2 seconds.

Scan the bar code below to select a new timeout. Next, scan two numeric bar codes beginning in [Numeric Bar Codes on page D-1](#) that correspond to the desired timeout. Single digit numbers must have a leading zero. For example, to set a timeout of 0.5 seconds, scan the bar code below, then scan the "0" and "5" bar codes. If an error is made, or to change a selection, scan [Cancel on page D-8](#).



Timeout Between Different Symbol

Time Delay to Low Power Mode

The scanner (after a period of inactivity) goes into low power mode and blinks infrequently to save power.

This parameter sets the time that the scanner remains active after any scanning activity. Scan one of the five options. Depending on the selection, the scanner enters a low power mode 15, 30, 60, 90 minutes or 127.5 hours (Extended) after the last attempted decode. To restore the scanner to full power mode, the user must simply use the scanner by presenting a barcode.



15 Minutes



***30 Minutes**

Time Delay to Low Power Mode (Continued)



60 Minutes



90 Minutes

Time Delay to Low Power Mode (Continued)

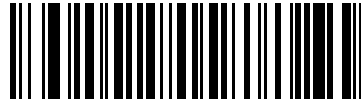

Extended (127.5 Hours)

5

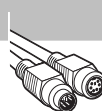

Keyboard Wedge Interface

Chapter Contents

Introduction	5-3
Connecting a Keyboard Wedge Interface	5-3
Keyboard Wedge Default Parameters	5-4
Keyboard Wedge Host Types	5-5
Keyboard Wedge Host Types	5-5
Keyboard Wedge Country Types (Country Codes)	5-8
Ignore Unknown Characters	5-14
Keystroke Delay	5-15
Intra-Keystroke Delay	5-17
Alternate Numeric Keypad Emulation	5-18
Caps Lock On	5-19
Caps Lock Override	5-20
Convert Wedge Data	5-21
Function Key Mapping	5-23
FN1 Substitution	5-24
Send Make Break	5-25
Keyboard Maps	5-26
ASCII Character Set	5-28

Introduction

This chapter covers Keyboard Wedge interface information for setting up the scanner. This interface type is used to attach the scanner between the keyboard and host computer. The scanner translates the bar code data into keystrokes. The host computer accepts the keystrokes as if they originate from the keyboard.

This mode of operation allows adding bar code reading functionality to a system designed for manual keyboard input. In this mode the keyboard keystrokes are simply passed through.

Throughout the programming bar code menus, default values are indicated with asterisks (*).



* Indicates Default — *North American — Feature/Option

Connecting a Keyboard Wedge Interface

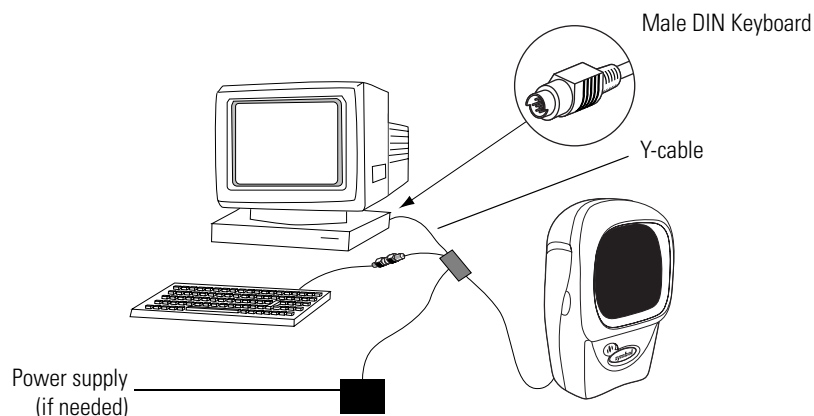

Figure 5-1. Keyboard Wedge Connection with Y-cable

To connect the Keyboard Wedge Y-cable:

1. Switch off the host and unplug the keyboard connector.
2. Attach the modular connector of the Y-cable to the cable interface port on the scanner. (See [Installing the Interface Cable on page 1-4.](#))
3. Connect the round male DIN host connector of the Y-cable to the keyboard port on the host device.
4. Connect the round female DIN keyboard connector of the Y-cable to the keyboard.
5. If needed, attach the optional power supply to the connector in the middle of the Y-cable.
6. Ensure that all connections are secure.
7. Switch on the host system.
8. Scan the appropriate bar codes in this chapter to configure the scanner.

Keyboard Wedge Default Parameters

Table 5-1 lists the defaults for Keyboard Wedge host parameters. To change any option, scan the appropriate bar code(s) provided in the Keyboard Wedge Host Parameters section beginning on page 5-5.

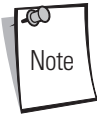

See [Chapter A, Standard Default Parameters](#) for all user preferences, hosts, symbologies, and miscellaneous default parameters.

Table 5-1. Keyboard Wedge Host Default Table

Parameter	Default	Page Number
Keyboard Wedge Host Parameters		
Keyboard Wedge Host Type	IBM PC/AT & IBM PC Compatibles ¹	5-5
Country Types (Country Codes)	North American	5-8
Ignore Unknown Characters	Send Bar Codes	5-14
Keystroke Delay	No Delay	5-15
Intra-Keystroke Delay	Disable	5-17
Alternate Numeric Keypad Emulation	Disable	5-18
Caps Lock On	Disable	5-19
Caps Lock Override	Disable	5-20
Convert Wedge Data	No Convert	5-21
Function Key Mapping	Disable	5-23
FN1 Substitution	Disable	5-24
Send Make Break	Disable	5-25
¹ User selection is required to configure this interface and this is the most common selection.		

Keyboard Wedge Host Types

Keyboard Wedge Host Types

Select the keyboard wedge host by scanning one of the bar codes below.

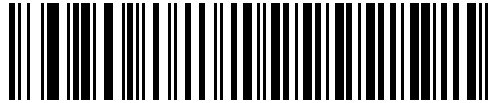

IBM PC/AT & IBM PC Compatibles¹



IBM PS/2 (Model 30)

Keyboard Wedge Host Types (Continued)

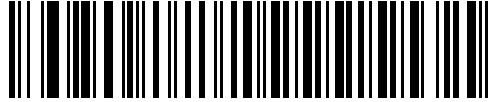

IBM AT NOTEBOOK



IBM XT

Keyboard Wedge Host Types (Continued)



NCR 7052



Note

¹User selection is required to configure this interface and this is the most common selection.

Keyboard Wedge Country Types (Country Codes)

Scan the bar code corresponding to the keyboard type. If the particular keyboard type is not listed, see [Alternate Numeric Keypad Emulation on page 5-18](#).



***North American**



German Windows

Keyboard Wedge Country Types (Continued)



French Windows



French Canadian Win 95/98

Keyboard Wedge Country Types (Continued)



French Canadian Windows XP/2000



Spanish Windows

Keyboard Wedge Country Types (Continued)



Italian Windows



Swedish Windows

Keyboard Wedge Country Types (Continued)



UK English Windows



Japanese Windows

Keyboard Wedge Country Types (Continued)



Brazilian/Portuguese Windows

Ignore Unknown Characters

Unknown characters are characters the host does not recognize. When **Send Bar Codes With Unknown Characters** is selected, all bar code data is sent except for unknown characters, and no error beeps sound on the scanner. When **Do Not Send Bar Codes With Unknown Characters** is selected, bar code data is sent up to the first unknown character and then an error beep will sound on the scanner.

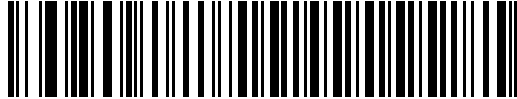

***Send Bar Codes With Unknown Characters**

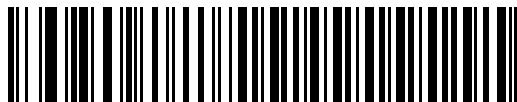

Do Not Send Bar Codes With Unknown Characters

Keystroke Delay

This is the delay in milliseconds between emulated keystrokes. Scan a bar code below to increase the delay when hosts require a slower transmission of data.



***No Delay**



Medium Delay (20 msec)

Keystroke Delay (Continued)



Long Delay (40 msec)

Intra-Keystroke Delay

When enabled, an additional delay is inserted between each emulated key depression and release. This sets the Keystroke Delay parameter to a minimum of 5 msec as well.



Enable

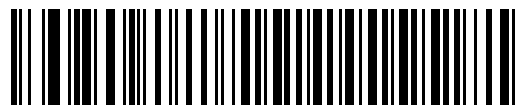

***Disable**

Alternate Numeric Keypad Emulation

This allows emulation of most other country keyboard types not listed in [Keyboard Wedge Country Types \(Country Codes\) on page 5-8](#) in a Microsoft operating system environment.

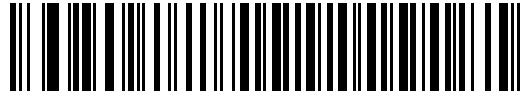

Enable Alternate Numeric Keypad



***Disable Alternate Numeric Keypad**

Caps Lock On

When enabled, the scanner emulates keystrokes as if the Caps Lock key is always pressed.



Enable Caps Lock On



***Disable Caps Lock On**

Caps Lock Override

When enabled, on AT or AT Notebook hosts, the keyboard ignores the state of the Caps Lock key. Therefore, an 'A' in the bar code is sent as an 'A' no matter what the state of the keyboard's Caps Lock key.



If both Caps Lock On and Caps Lock Override are enabled, Caps Lock Override takes precedence.

Convert Wedge Data

When enabled, the scanner will convert all bar code data to the selected case.



Convert to Upper Case

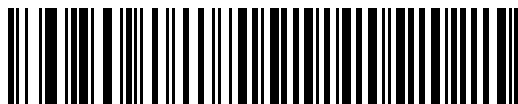

Convert to Lower Case

Convert Wedge Data (Continued)



***No Convert**

Function Key Mapping

ASCII values under 32 are normally sent as a control-key sequences (see Table 7-2 on page 7-24). When this parameter is enabled, the keys in bold are sent in place of the standard key mapping. Table entries that do not have a bold entry remain the same whether or not this parameter is enabled.

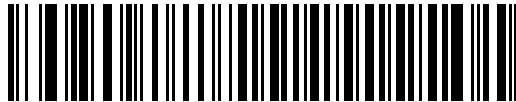

Enable



***Disable**

FN1 Substitution

When enabled, this allows replacement of any FN1 characters in an Code 128 or EAN 128 bar code with a Key Category and Key Value choose by the user (see "FN1 Substitution Values" on page 9).



Enable

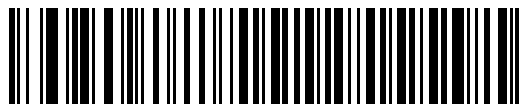

***Disable**

Send Make Break

When enabled, the scan codes for releasing a key are not sent.

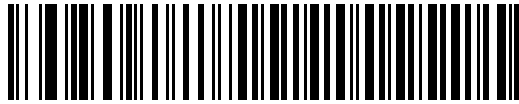

***Send Make and Break Scan Codes**

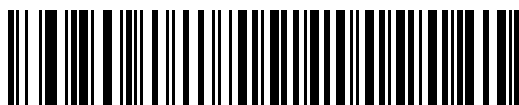

Send Make Scan Code Only

Keyboard Maps

The following keyboard maps are provided for prefix/suffix keystroke parameters. To program the prefix/suffix values, see the bar codes on page 10-6.

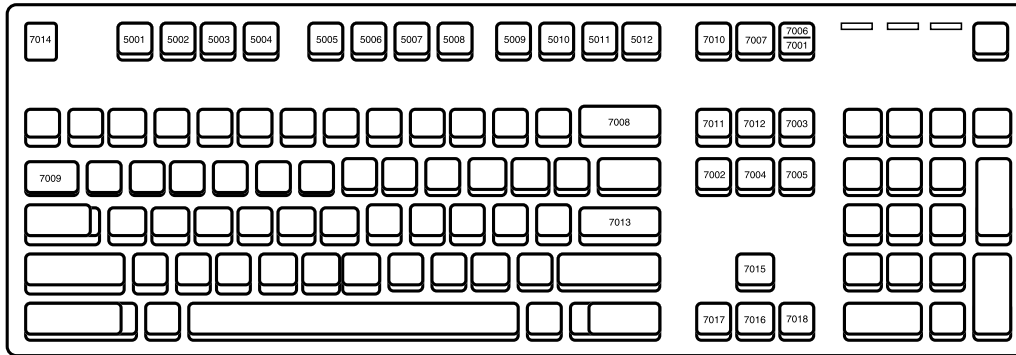

Figure 5-2. IBM PS2 Type Keyboard

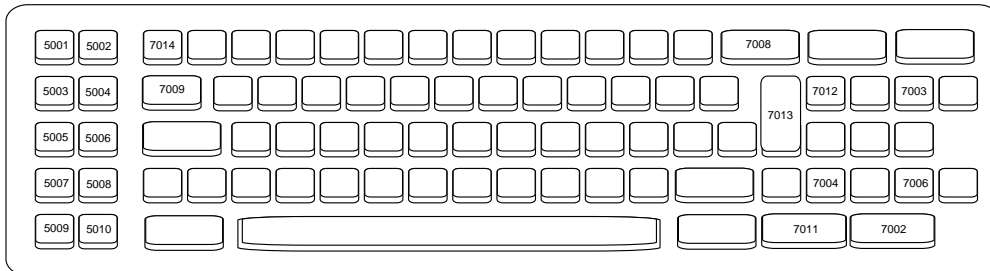

Figure 5-3. IBM PC/XT

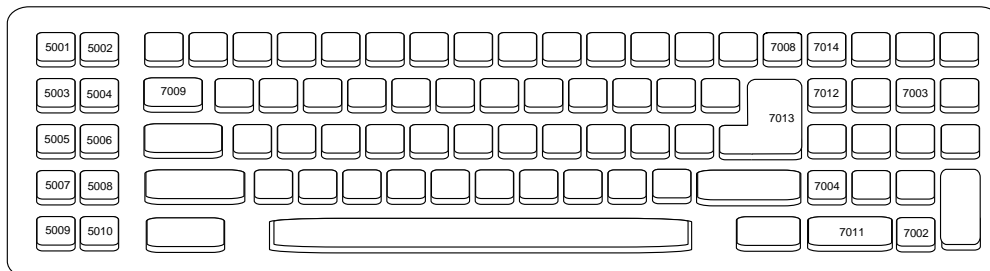

Figure 5-4. IBM PC/AT

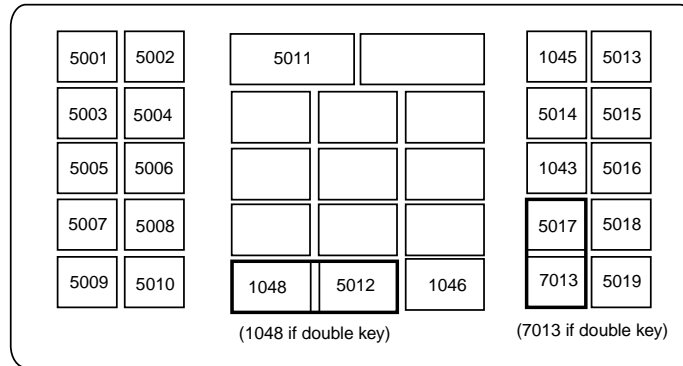

Figure 5-5. NCR 7052 32-KEY

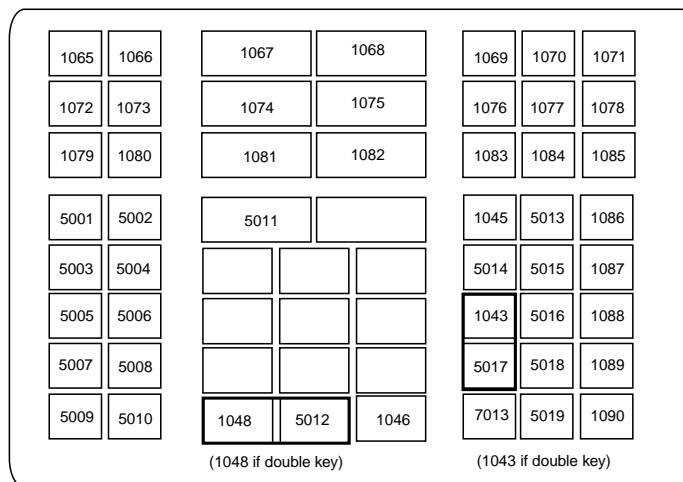
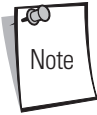

Figure 5-6. NCR 7052 58-KEY

ASCII Character Set



Code 39 Full ASCII interprets the bar code special character (\$+ % /) preceding a Code 39 character and assigns an ASCII character value to the pair. For example, when Code 39 Full ASCII is enabled and a **+B** is scanned, it is interpreted as **b**, **%J** as **?**, and **%V** as **@**. Scanning **ABC%I** outputs the keystroke equivalent of **ABC >**.

Table 5-2. Keyboard Wedge ASCII Character Set

ASCII Value	Full ASCII Code 39 Encode Character	Keystroke
1001	\$A	CTRL A
1002	\$B	CTRL B
1003	\$C	CTRL C
1004	\$D	CTRL D
1005	\$E	CTRL E
1006	\$F	CTRL F
1007	\$G	CTRL G
1008	\$H	CTRL H/ BACKSPACE ¹
1009	\$I	CTRL I/ HORIZONTAL TAB ¹
1010	\$J	CTRL J
1011	\$K	CTRL K
1012	\$L	CTRL L
1013	\$M	CTRL M/ ENTER ¹
1014	\$N	CTRL N
1015	\$O	CTRL O
1016	\$P	CTRL P
1017	\$Q	CTRL Q
1018	\$R	CTRL R
1019	\$S	CTRL S
1020	\$T	CTRL T
1021	\$U	CTRL U
1022	\$V	CTRL V
1023	\$W	CTRL W
1024	\$X	CTRL X
1025	\$Y	CTRL Y
1026	\$Z	CTRL Z
1027	%A	CTRL [/ ESC ¹
1028	%B	CTRL \

¹The keystroke in bold is sent only if the "Function Key Mapping" is enabled. Otherwise, the unbolded keystroke is sent.

Table 5-2. Keyboard Wedge ASCII Character Set (Continued)

ASCII Value	Full ASCII Code 39 Encode Character	Keystroke
1029	%C	CTRL]
1030	%D	CTRL 6
1031	%E	CTRL -
1032	Space	Space
1033	/A	!
1034	/B	"
1035	/C	#
1036	/D	\$
1037	/E	%
1038	/F	&
1039	/G	'
1040	/H	(
1041	/I)
1042	/J	*
1043	/K	+
1044	/L	,
1045	-	-
1046	.	.
1047	/O	/
1048	0	0
1049	1	1
1050	2	2
1051	3	3
1052	4	4
1053	5	5
1054	6	6
1055	7	7
1056	8	8
1057	9	9
1058	/Z	:
1059	%F	;
1060	%G	<
1061	%H	=

¹The keystroke in bold is sent only if the "Function Key Mapping" is enabled. Otherwise, the unbolded keystroke is sent.

Table 5-2. Keyboard Wedge ASCII Character Set (Continued)

ASCII Value	Full ASCII Code 39 Encode Character	Keystroke
1062	%I	>
1063	%J	?
1064	%V	@
1065	A	A
1066	B	B
1067	C	C
1068	D	D
1069	E	E
1070	F	F
1071	G	G
1072	H	H
1073	I	I
1074	J	J
1075	K	K
1076	L	L
1077	M	M
1078	N	N
1079	O	O
1080	P	P
1081	Q	Q
1082	R	R
1083	S	S
1084	T	T
1085	U	U
1086	V	V
1087	W	W
1088	X	X
1089	Y	Y
1090	Z	Z
1091	%K	[
1092	%L	\
1093	%M]
1094	%N	^

¹The keystroke in bold is sent only if the "Function Key Mapping" is enabled. Otherwise, the unbolded keystroke is sent.

Table 5-2. Keyboard Wedge ASCII Character Set (Continued)

ASCII Value	Full ASCII Code 39 Encode Character	Keystroke
1095	%O	–
1096	%W	'
1097	+A	a
1098	+B	b
1099	+C	c
1100	+D	d
1101	+E	e
1102	+F	f
1103	+G	g
1104	+H	h
1105	+I	i
1106	+J	j
1107	+K	k
1108	+L	l
1109	+M	m
1110	+N	n
1111	+O	o
1112	+P	p
1113	+Q	q
1114	+R	r
1115	+S	s
1116	+T	t
1117	+U	u
1118	+V	v
1119	+W	w
1120	+X	x
1121	+Y	y
1122	+Z	z
1123	%P	{
1124	%Q	
1125	%R	}
1126	%S	~

¹The keystroke in bold is sent only if the "Function Key Mapping" is enabled. Otherwise, the unbolded keystroke is sent.

Table 5-3. Keyboard Wedge ALT Key Character Set

ALT Keys	Keystroke
2065	ALT A
2066	ALT B
2067	ALT C
2068	ALT D
2069	ALT E
2070	ALT F
2071	ALT G
2072	ALT H
2073	ALT I
2074	ALT J
2075	ALT K
2076	ALT L
2077	ALT M
2078	ALT N
2079	ALT O
2080	ALT P
2081	ALT Q
2082	ALT R
2083	ALT S
2084	ALT T
2085	ALT U
2086	ALT V
2087	ALT W
2088	ALT X
2089	ALT Y
2090	ALT Z

Table 5-4. Keyboard Wedge GUI Key Character Set

GUI Keys	Keystrokes
3000	Right Control Key
3048	GUI 0
3049	GUI 1
3050	GUI 2
3051	GUI 3
3052	GUI 4
3053	GUI 5
3054	GUI 6
3055	GUI 7
3056	GUI 8
3057	GUI 9
3065	GUI A
3066	GUI B
3067	GUI C
3068	GUI D
3069	GUI E
3070	GUI F
3071	GUI G
3072	GUI H
3073	GUI I
3074	GUI J
3075	GUI K
3076	GUI L
3077	GUI M
3078	GUI N
3079	GUI O
3080	GUI P
3081	GUI Q
3082	GUI R
3083	GUI S
3084	GUI T
3085	GUI U
3086	GUI V
3087	GUI W
3088	GUI X
3089	GUI Y

Table 5-4. Keyboard Wedge GUI Key Character Set (Continued)

GUI Keys	Keystrokes
3090	GUI Z

Table 5-5. Keyboard Wedge F Key Character Set

F Keys	Keystroke
5001	F1
5002	F2
5003	F3
5004	F4
5005	F5
5006	F6
5007	F7
5008	F8
5009	F9
5010	F10
5011	F11
5012	F12
5013	F13
5014	F14
5015	F15
5016	F16
5017	F17
5018	F18
5019	F19
5020	F20
5021	F21
5022	F22
5023	F23
5024	F24

Table 5-6. Keyboard Wedge Numeric Keypad Character Set

Numeric Keypad	Keystroke
6042	*
6043	+
6044	undefined
6045	-
6046	.
6047	/
6048	0
6049	1
6050	2
6051	3
6052	4
6053	5
6054	6
6055	7
6056	8
6057	9
6058	Enter
6059	Num Lock

Table 5-7. Keyboard Wedge Extended Keypad Character Set

Extended Keypad	Keystroke
7001	Break
7002	Delete
7003	Pg Up
7004	End
7005	Pg Dn
7006	Pause
7007	Scroll Lock
7008	Backspace
7009	Tab
7010	Print Screen
7011	Insert
7012	Home
7013	Enter
7014	Escape
7015	Up Arrow
7016	Dn Arrow
7017	Left Arrow
7018	Right Arrow

6



RS-232 Interface

Chapter Contents

Introduction	6-3
Connecting an RS-232 Interface	6-3
RS-232 Default Parameters	6-3
RS-232 Host Parameters	6-5
RS-232 Host Types	6-7
Baud Rate	6-11
Parity	6-15
Check Receive Errors	6-18
Hardware Handshaking	6-19
Software Handshaking	6-22
Host Serial Response Time-out	6-25
RTS Line State	6-28
Stop Bit Select	6-29
Data Bits	6-30
Beep on <BEL>	6-31
Intercharacter Delay	6-32
Nixdorf Beep/LED Options	6-35
Ignore Unknown Characters	6-37
ASCII / Character Set	6-38

Introduction

This chapter covers RS-232 host information for setting up the scanner. The RS-232 interface is used to attach the scanner to point-of-sale devices, host computers, or other devices with an available RS-232 port (e.g., com port).



This scanner utilizes TTL RS-232 signal levels, which will interface with most system architectures. For system architectures requiring RS-232C signal levels, Motorola offers different cables providing the TTL to RS-232C conversion. Please contact the Global Customer Interaction Center for more information.

If the particular host is not listed in [Table 6-2 on page 6-5](#), set the communication parameters to match the host device. To set communication parameters for hosts not listed, refer to the documentation for the host device.

Throughout the programming bar code menus, default values are indicated with asterisks (*).



Connecting an RS-232 Interface

This connection is made directly from the scanner to the host computer.

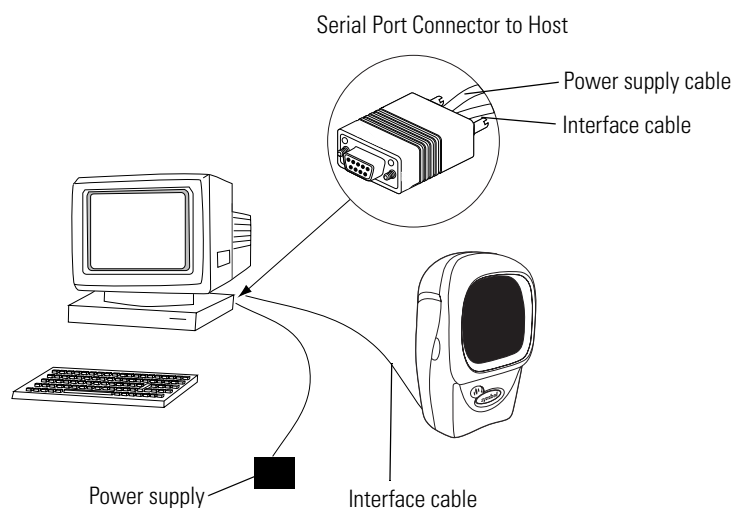

Figure 6-1. RS-232 Direct Connection

1. Connect the RS-232 interface cable to the rear of the scanner, as described in [Installing the Interface Cable on page 1-4](#).
2. Connect the other end of the interface cable to the serial port on the host.
3. Connect the power supply.
4. Scan appropriate bar codes in this chapter to match the host settings.

RS-232 Default Parameters

[Table 6-1](#) lists the defaults for RS-232 host parameters. To change any option, scan the appropriate bar code(s) provided in the Parameter Descriptions section beginning on page [6-5](#).



See [Chapter A, Standard Default Parameters](#) for all user preferences, hosts, symbologies, and miscellaneous default parameters.

Table 6-1. RS-232 Host Default Table

Parameter	Default	Page Number
RS-232 Host Parameters		
RS-232 Host Types	Standard ¹	6-7
Baud Rate	9600	6-11
Parity	None	6-15
Check Receive Errors	Enable	6-18
Hardware Handshaking	None	6-19
Software Handshaking	None	6-22
Host Serial Response Time-out	2 Sec	6-25
RTS Line State	Low RTS	6-28
Stop Bit Select	1	6-29
Data Bits	8-Bit	6-30
Beep on <BEL>	Disable	6-31
Intercharacter Delay	0 msec	6-32
Nixdorf Beep/LED Option	Normal Operation	6-35
Ignore Unknown Characters	Send Bar Codes	6-37
¹ User selection is required to configure this interface and this is the most common selection.		

RS-232 Host Parameters

Various RS-232 hosts are set up with their own parameter default settings (Table). Selecting the ICL, Fujitsu, Wincor-Nixdorf Mode A, Wincor-Nixdorf Mode B, Olivetti, Omron, or terminal sets the defaults listed below.

Table 6-2. Terminal Specific RS-232

Parameter	Standard (Default)	ICL	Fujitsu	Wincor-Nixdorf Mode A	Wincor-Nixdorf Mode B/OPOS	Olivetti	Omron
Transmit Code ID	No	Yes	Yes	Yes	Yes	Yes	Yes
Data Transmission Format	Data as is	Data/Suffix	Data/Suffix	Data/Suffix	Data/Suffix	Prefix/Data/Suffix	Data/Suffix
Suffix	CR/LF (7013)	CR (1013)	CR (1013)	CR (1013)	CR (1013)	ETX (1002)	CR (1013)
Baud Rate	9600	9600	9600	9600	9600	9600	9600
Parity	None	Even	None	Odd	Odd	Even	None
Hardware Handshaking	None	RTS/CTS Option 3	None	RTS/CTS Option 3	RTS/CTS Option 3	None	None
Software Handshaking	None	None	None	None	None	Ack/Nak	None
Serial Response Time-out	2 Sec.	9.9 Sec.	2 Sec.	9.9 Sec.	9.9 Sec.	9.9 Sec.	9.9 Sec.
Stop Bit Select	One	One	One	One	One	One	One
ASCII Format	8-Bit	8-Bit	8-Bit	8-Bit	8-Bit	7-Bit	8-Bit
Beep On <BEL>	Disable	Disable	Disable	Disable	Disable	Disable	Disable
RTS Line State	Low	High	Low	Low	Low = No data to send	Low	High
Prefix	None	None	None	None	None	STX (1003)	None

*In the Nixdorf Mode B, if CTS is Low, scanning is disabled. When CTS is High, the user can scan bar codes.

**If Nixdorf Mode B is scanned without the scanner connected to the proper host, it may appear unable to scan. If this happens, scan a different RS-232 host type within 5 seconds of cycling power to the scanner.

Selecting the ICL, Fujitsu, Wincor-Nixdorf Mode A, Wincor-Nixdorf Mode B, OPOS, JPOS terminal enables the transmission of code ID characters listed in Table below. These code ID characters are not programmable and are separate from the Transmit Code ID feature. The Transmit Code ID feature should not be enabled for these terminals.

RS-232 Host Types

To select an RS-232 host interface, scan one of the following bar codes.



Standard RS-232¹



ICL RS-232



¹User selection is required to configure this interface and this is the most common selection.

RS-232 Host Types (Continued)



Wincor-Nixdorf RS-232 Mode A



Wincor-Nixdorf RS-232 Mode B



Note

¹User selection is required to configure this interface and this is the most common selection.

RS-232 Host Types (continued)



Fujitsu RS-232



Olivetti ORS4500

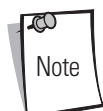

¹User selection is required to configure this interface and this is the most common selection.

RS-232 Host Types (continued)

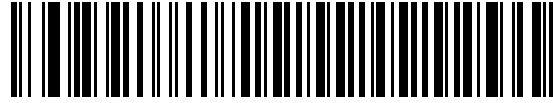

Omron



OPOS/JPOS



Note

¹User selection is required to configure this interface and this is the most common selection.

Baud Rate

Baud rate is the number of bits of data transmitted per second. The scanner's baud rate setting should match the baud rate setting of the host device. If not, data may not reach the host device or may reach it in distorted form.

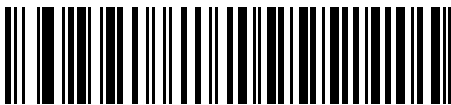

Baud Rate 600

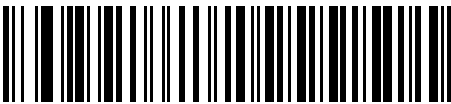

Baud Rate 1200

Baud Rate (continued)



Baud Rate 2400



Baud Rate 4800

Baud Rate (continued)

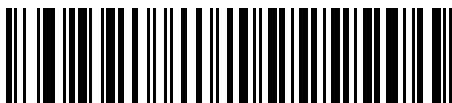

*** Baud Rate 9600**

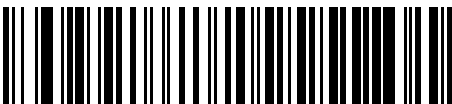

Baud Rate 19,200

Baud Rate (continued)



Baud Rate 38,400

Parity

A parity check bit is the most significant bit of each ASCII coded character. Select the parity type according to host device requirements.

Select **Odd** parity and the parity bit value is set to 0 or 1, based on data, to ensure that an odd number of 1 bits are contained in the coded character.



Odd

Select **Even** parity and the parity bit value is set to 0 or 1, based on data, to ensure that an even number of 1 bits are contained in the coded character.



Even

Parity (Continued)

Select **Mark** parity and the parity bit is always 1.

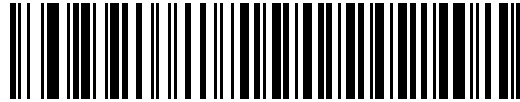

Mark

Select **Space** parity and the parity bit is always 0.



Space

Parity (Continued)

Select **None** when no parity bit is required.



***None**

Check Receive Errors

Select whether or not the parity, framing, and overrun of received characters are checked. The parity value of received characters is verified against the parity parameter selected above.



***Check For Received Errors**



Do Not Check For Received Errors

Hardware Handshaking

The data interface consists of an RS-232 port designed to operate either with or without the hardware handshaking lines, *Request to Send (RTS)*, and *Clear to Send (CTS)*.

If Standard RTS/CTS handshaking is not selected, scan data is transmitted as it becomes available. If Standard RTS/CTS handshaking is selected, scan data is transmitted according to the following sequence:

- The scanner reads the CTS line for activity. If CTS is asserted, the scanner waits up to 2 seconds for the host to negate the CTS line. If, after 2 seconds (default), the CTS line is still asserted, the scanner sounds a transmit error, and any scanned data is lost.
- When the CTS line is negated, the scanner asserts the RTS line and waits up to 2 seconds for the host to assert CTS. When the host asserts CTS, data is transmitted. If, after 2 seconds (default), the CTS line is not asserted, the scanner sounds a transmit error, and discards the data.
- When data transmission is complete, the scanner negates RTS 10 msec after sending the last character.
- The host should respond by negating CTS. The scanner checks for a negated CTS upon the next transmission of data.

During the transmission of data, the CTS line should be asserted. If CTS is deasserted for more than 50 ms between characters, the transmission is aborted, the scanner sounds a transmission error, and the data is discarded.

If the above communications sequence fails, the scanner issues an error indication. In this case, the data is lost and must be rescanned.

If Hardware Handshaking and Software Handshaking are both enabled, Hardware Handshaking takes precedence.



The DTR signal is jumpered to the active state.

None

Scan the bar code below if no Hardware Handshaking is desired.

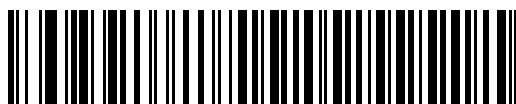

***None**

Standard RTS/CTS

Scan the bar code below to select Standard RTS/CTS Hardware Handshaking.

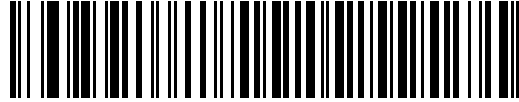

Standard RTS/CTS

RTS/CTS Option 1

When RTS/CTS Option 1 is selected, the scanner asserts RTS before transmitting and ignores the state of CTS. The scanner de-asserts RTS when the transmission is complete.

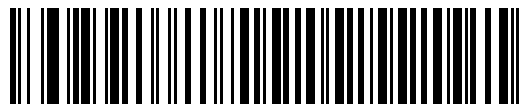

RTS/CTS Option 1

RTS/CTS Option 2

When Option 2 is selected, RTS is always high or low (user-programmed logic level). However, the scanner waits for CTS to be asserted before transmitting data. If CTS is not asserted within 2 seconds (default), the scanner issues an error indication and discards the data.

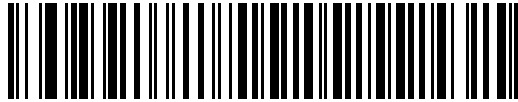

RTS/CTS Option 2

RTS/CTS Option 3

When Option 3 is selected, the scanner asserts RTS prior to any data transmission, regardless of the state of CTS. The scanner waits up to 2 seconds (default) for CTS to be asserted. If CTS is not asserted during this time, the scanner issues an error indication and discards the data. The scanner de-asserts RTS when transmission is complete.



RTS/CTS Option 3

Software Handshaking

This parameter offers control of the data transmission process in addition to, or instead of, that offered by hardware handshaking. There are five options.

If Software Handshaking and Hardware Handshaking are both enabled, Hardware Handshaking takes precedence.

None

When this option is selected, data is transmitted immediately.

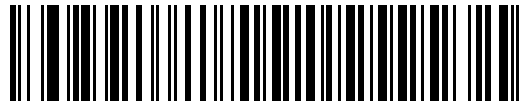

***None**

ACK/NAK

When this option is selected, after transmitting data, the scanner expects either an ACK or NAK response from the host. When a NAK is received, the scanner transmits the same data again and waits for either an ACK or NAK. After three unsuccessful attempts to send data when NAKs are received, the scanner issues an error indication and discards the data.

The scanner waits up to the programmable Host Serial Response Time-out to receive an ACK or NAK. If the scanner does not get a response in this time, it issues an error indication and discards the data. There are no retries when a time-out occurs.



ACK/NAK

ENQ

When this option is selected, the scanner waits for an ENQ character from the host before transmitting data. If an ENQ is not received within the Host Serial Response Time-out, the scanner issues an error indication and discards the data. The host must transmit an ENQ character at least every Host Serial Response Time-out to prevent transmission errors.



ENQ

ACK/NAK with ENQ

This combines the two previous options.



ACK/NAK with ENQ

XON/XOFF

An XOFF character turns the scanner transmission off until the scanner receives an XON character. There are two situations for XON/XOFF:

- XOFF is received before the scanner has data to send. When the scanner has data to send, it waits up to 2 seconds for an XON character before transmission. If the XON is not received within this time, the scanner issues an error indication and discards the data.
- XOFF is received during a transmission. Data transmission then stops after sending the current byte. When the scanner receives an XON character, it sends the rest of the data message. The scanner waits indefinitely for the XON.

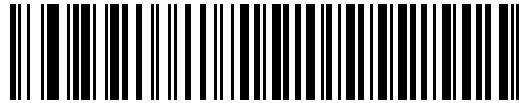

XON/XOFF

Host Serial Response Time-out

This parameter specifies how long the scanner waits for an ACK, NAK, or CTS before determining that a transmission error has occurred. This only applies when in one of the ACK/NAK Software Handshaking modes, or RTS/CTS Hardware Handshaking option.



***Minimum: 2 Sec**

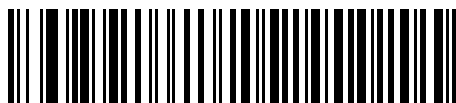

Low: 2.5 Sec

Host Serial Response Time-out (Continued)



Medium: 5 Sec



High: 7.5 Sec

Host Serial Response Time-out (Continued)



Maximum: 9.9 Sec

RTS Line State

This parameter sets the idle state of the Serial Host RTS line. Scan a bar code below to select **Low RTS** or **High RTS** line state.



***Host: Low RTS**

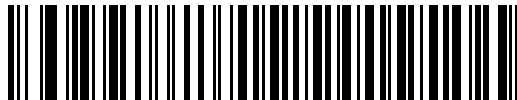

Host: High RTS

Stop Bit Select

The stop bit(s) at the end of each transmitted character marks the end of transmission of one character and prepares the receiving device for the next character in the serial data stream. The number of stop bits selected (one or two) depends on the number the receiving terminal is programmed to accommodate. Set the number of stop bits to match host device requirements.



***1 Stop Bit**



2 Stop Bits

Data Bits

This parameter allows the scanner to interface with devices requiring a 7-bit or 8-bit ASCII protocol.

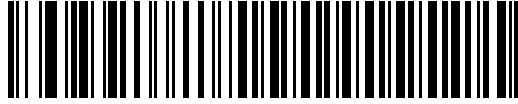

7-Bit

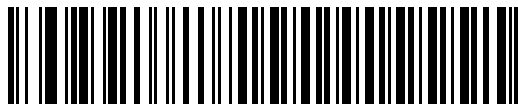

***8-Bit**

Beep on <BEL>

When this parameter is enabled, the scanner issues a beep when a <BEL> character is detected on the RS-232 serial line. <BEL> is issued to gain a user's attention to an illegal entry or other important event.

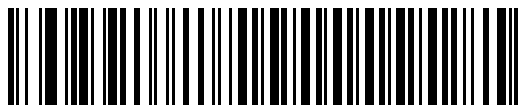

**Beep On <BEL> Character
(Enable)**

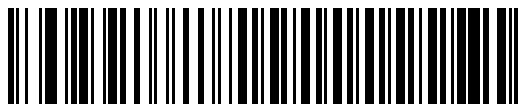

***Do Not Beep On <BEL> Character
(Disable)**

Intercharacter Delay

This parameter specifies the intercharacter delay inserted between character transmissions.



***Minimum: 0 msec**



Low: 25 msec

Intercharacter Delay (Continued)



Medium: 50 msec

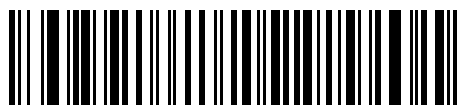

High: 75 msec

Intercharacter Delay (Continued)



Maximum: 99 msec

Nixdorf Beep/LED Options

When Nixdorf Mode B is selected, this indicates when the scanner should beep and turn on its LED after a decode.



***Normal Operation
(Beep/LED immediately after decode)**



Beep/LED After Transmission

Nixdorf Beep/LED Options (Continued)



Beep/LED After CTS Pulse

Ignore Unknown Characters

Unknown characters are characters the host does not recognize. When **Send Bar Codes With Unknown Characters** is selected, all bar code data is send except for unknown characters, and no error beeps sound on the scanner. When **Do Not Send Bar Codes With Unknown Characters** is selected, bar code data is sent up to the first unknown character and then an error beep will sound on the scanner.



***Send Bar Code
(With Unknown Characters)**

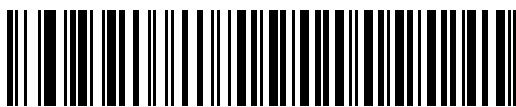

**Do Not Send Bar Codes
(With Unknown Characters)**

ASCII / Character Set

The values in [Table 6-4](#) can be assigned as prefixes or suffixes for ASCII character data transmission.

Table 6-4. RS-232 Prefix/Suffix Values

Prefix/Suffix Value	Full ASCII Code 39 Encode Character	ASCII Character
1000	%U	NUL
1001	\$A	SOH
1002	\$B	STX
1003	\$C	ETX
1004	\$D	EOT
1005	\$E	ENQ
1006	\$F	ACK
1007	\$G	BELL
1008	\$H	BCKSPC
1009	\$I	HORIZ TAB
1010	\$J	LF/NW LN
1011	\$K	VT
1012	\$L	FF
1013	\$M	CR/ENTER
1014	\$N	SO
1015	\$O	SI
1016	\$P	DLE
1017	\$Q	DC1/XON
1018	\$R	DC2
1019	\$S	DC3/XOFF
1020	\$T	DC4
1021	\$U	NAK
1022	\$V	SYN
1023	\$W	ETB
1024	\$X	CAN
1025	\$Y	EM
1026	\$Z	SUB
1027	%A	ESC
1028	%B	FS
1029	%C	GS
1030	%D	RS
1031	%E	US
1032	Space	Space
1033	/A	!

Table 6-4. RS-232 Prefix/Suffix Values (Continued)

Prefix/Suffix Value	Full ASCII Code 39 Encode Character	ASCII Character
1034	/B	"
1035	/C	#
1036	/D	\$
1037	/E	%
1038	/F	&
1039	/G	'
1040	/H	(
1041	/I)
1042	/J	*
1043	/K	+
1044	/L	,
1045	-	-
1046	.	.
1047	/O	/
1048	0	0
1049	1	1
1050	2	2
1051	3	3
1052	4	4
1053	5	5
1054	6	6
1057	7	7
1056	8	8
1057	9	9
1058	/Z	:
1059	%F	;
1060	%G	<
1061	%H	=
1062	%I	>
1063	%J	?
1064	%V	@
1065	A	A
1066	B	B
1067	C	C
1068	D	D
1069	E	E

Table 6-4. RS-232 Prefix/Suffix Values (Continued)

Prefix/Suffix Value	Full ASCII Code 39 Encode Character	ASCII Character
1070	F	F
1071	G	G
1072	H	H
1073	I	I
1074	J	J
1075	K	K
1076	L	L
1077	M	M
1078	N	N
1079	O	O
1080	P	P
1081	Q	Q
1082	R	R
1083	S	S
1084	T	T
1085	U	U
1086	V	V
1087	W	W
1088	X	X
1089	Y	Y
1090	Z	Z
1091	%K	[
1092	%L	\
1093	%M]
1094	%N	^
1095	%O	_
1096	%W	`
1097	+A	a
1098	+B	b
1099	+C	c
1100	+D	d
1101	+E	e
1102	+F	f
1103	+G	g
1104	+H	h
1105	+I	i

Table 6-4. RS-232 Prefix/Suffix Values (Continued)

Prefix/Suffix Value	Full ASCII Code 39 Encode Character	ASCII Character
1106	+J	j
1107	+K	k
1108	+L	l
1109	+M	m
1110	+N	n
1111	+O	o
1112	+P	p
1113	+Q	q
1114	+R	r
1115	+S	s
1116	+T	t
1117	+U	u
1118	+V	v
1119	+W	w
1120	+X	x
1121	+Y	y
1122	+Z	z
1123	%P	{
1124	%Q	
1125	%R	}
1126	%S	~
1127		Undefined
7013		ENTER



Chapter Contents

Introduction	7-3
Connecting a USB Interface	7-3
USB Default Parameters	7-4
USB Host Parameters	7-5
USB Device Type	7-5
USB Country Keyboard Types (Country Codes)	7-8
USB Keystroke Delay	7-14
USB CAPS Lock Override	7-16
USB Ignore Unknown Characters	7-17
Emulate Keypad	7-18
USB Keyboard FN1 Substitution	7-19
Function Key Mapping	7-20
Simulated Caps Lock	7-21
Convert Case	7-22
ASCII Character Set	7-24

Introduction

This chapter covers the connection and setup of the scanner to a USB host. The scanner attaches directly to a USB host, or a powered USB hub, and is powered by it. No additional power supply is required.

Throughout the programming bar code menus, default values are indicated with asterisks (*).



Connecting a USB Interface

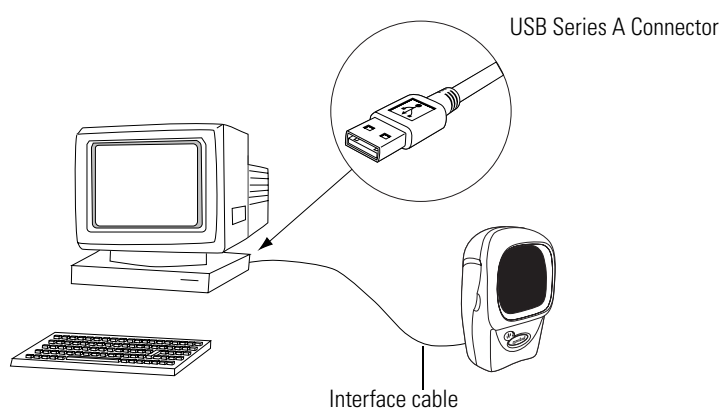

Figure 7-1. USB Connection

The scanner connects with USB capable hosts including:

- Desktop PCs and Notebooks
- Apple™ iMac, G4, iBooks (North America only)
- IBM SurePOS terminals
- Sun, IBM, and other network computers that support more than one keyboard.

The following operating systems support the scanner through USB:

- Windows 98, 2000, ME, XP
- MacOS 8.5 and above
- IBM 4690 OS.

The scanner will also interface with other USB hosts which support USB Human Interface Devices (HID). For more information on USB technology, hosts, and peripheral devices, visit www.symbol.com/usb.

To set up the scanner:

1. Connect the USB interface cable to the rear of the scanner, as described in [Installing the Interface Cable on page 1-4](#).
2. Plug the series A connector in the USB host or hub, or plug the Plus Power connector in an available port of the IBM SurePOS terminal.

3. Select the USB device type. See [USB Device Type on page 7-5](#).
4. On first installation when using Windows, the software prompts to select or install the “Human Interface Device” driver. To install the “Human Interface Device” driver provided by Windows click “Next” through all the choices and click “Finished” on the last choice. The scanner powers up during this installation.
5. If not using a North American keyboard, scan the appropriate country bar code under [USB Country Keyboard Types \(Country Codes\) on page 7-8](#).

If there are any problems with the system, see [Troubleshooting on page 3-3](#).

USB Default Parameters

[Table 7-1](#) lists the defaults for USB host parameters. To change any option, scan the appropriate bar code(s) provided in the Parameter Descriptions section beginning on page [7-5](#).



See [Chapter A, Standard Default Parameters](#) for all user preferences, hosts, symbologies, and miscellaneous default parameters.

Table 7-1. USB Host Default Table

Parameter	Default	Page Number
USB Host Parameters		
USB Device Type	HID (Human Interface Device) Keyboard Emulation	7-5
USB Country Keyboard Types (Country Codes)	North American	7-8
USB Keystroke Delay	No Delay	7-14
USB CAPS Lock Override	Disable	7-16
USB Ignore Unknown Characters	Send Bar Codes	7-17
Emulate Keypad	Disable	7-18
USB Keyboard FN1 Substitution	Disable	7-19
Function Key Mapping	Disable	7-20
Simulated Caps Lock	Disable	7-21
Convert Case	Disable	7-22

USB Host Parameters

USB Device Type

Select the desired USB device type.

- **HID Keyboard Emulation** (default) - This device type allows the scanner to emulate a USB keyboard. When a bar code is successfully decoded, bar code data is transmitted to the console as if the data was typed on a keyboard. No special drivers are required as **HID Keyboard Emulation** is supported by most USB drivers.
- **IBM Table Top USB** - This device type is used with table top scanners connecting to a cash register with IBM OEM specification compliant drivers (supplied by the cash register vendor). **IBM Table Top USB** requires drivers supplied by the Point-of-Service (POS) device vendor. Check with the POS vendor to verify the drivers used.
- **IBM Hand-Held USB** - This device type is used with hand-held scanners connecting to a cash register with IBM OEM specification compliant drivers (supplied by the cash register vendor). **IBM Hand-Held USB** requires drivers supplied by the Point-of-Service (POS) device vendor. Check with the POS vendor to verify the drivers used.

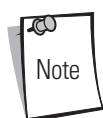

Note

When connecting two scanners to a host, IBM does not permit the selection of two of the same device types. When two connections are required, select **IBM Table Top USB** for one scanner and **IBM Hand-Held USB** for the second scanner.

- **USB OPOS Hand-Held** - This device type is used with Symbol's OPOS/JPOS compliant drivers, which can be downloaded from Symbol's Software Developer Zone at <http://devzone.symbol.com>. Motorola only supports one OPOS connection per host.
- **Simple COM Port Emulation** - This device type requires a Motorola driver download from the Software Developer Zone at <http://devzone.symbol.com>. When the scanner is connected to the host the next available comm port is automatically selected, emulating a one-way RS-232 connection. No handshaking is supported. No baud settings are required.



Note

When changing USB Device Types, the scanner automatically restarts. The scanner issues the standard startup beep sequences.



*HID Keyboard Emulation

USB Device Type (Continued)



IBM Table Top USB

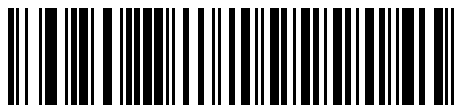

IBM Hand-Held USB

USB Device Type (Continued)



USB OPOS Hand-Held



Simple COM Port Emulation

USB Country Keyboard Types (Country Codes)

Scan the bar code corresponding to the keyboard type. This setting applies only to the USB HID Keyboard Emulation device.



When changing Country Selection, the scanner automatically restarts. The scanner issues the standard startup beep sequences.



***North American, Standard USB Keyboard**



French, Windows

USB Country Keyboard Types (Continued)



German, Windows



French Canadian, Windows

USB Country Keyboard Types (Continued)



French Canadian, Windows 2000/XP



Spanish (Traditional), Windows

USB Country Keyboard Types (Continued)

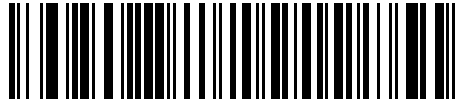

Italian, Windows

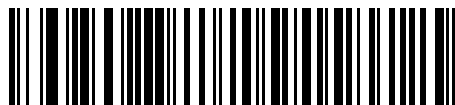

Swedish, Windows

USB Country Keyboard Types (Continued)



UK English, Windows

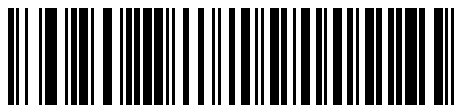

Japanese, Windows (ASCII)

USB Country Keyboard Types (Continued)

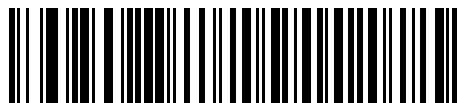

Portuguese-Brazilian, Windows

USB Keystroke Delay

This parameter sets the delay, in milliseconds, between emulated keystrokes. Scan a bar code below to increase the delay when hosts require a slower transmission of data.



***No Delay**



Medium Delay (20 msec)

USB Keystroke Delay (Continued)

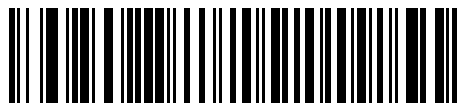

Long Delay (40 msec)

USB CAPS Lock Override

This option applies only to the HID Keyboard Emulation device. When enabled, the case of the data is preserved regardless of the state of the caps lock key. This setting is always enabled for the "Japanese, Windows (ASCII)" keyboard type and can not be disabled.



**Override Caps Lock Key
(Enable)**



***Do Not Override Caps Lock Key
(Disable)**

USB Ignore Unknown Characters

This option applies only to the HID Keyboard Emulation device and IBM device. Unknown characters are characters the host does not recognize. When **Send Bar Codes With Unknown Characters** is selected, all bar code data is sent except for unknown characters, and no error beeps sound. When **Do Not Send Bar Codes With Unknown Characters** is selected, bar codes containing at least one unknown character are not sent to the host, and an error beep sounds.

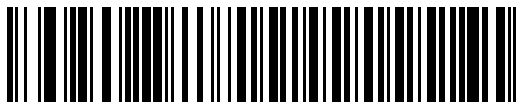

***Send Bar Codes With Unknown Characters**



**Do Not Send Bar Codes With Unknown Characters
(Disable)**

Emulate Keypad

When enabled, all characters are sent as ASCII sequences over the numeric keypad. For example ASCII A would be sent as "ALT make" 0 6 5 "ALT Break".



***Disable Keypad Emulation**



Enable Keypad Emulation

USB Keyboard FN1 Substitution

This option applies only to the USB HID Keyboard Emulation device. When enabled, this allows replacement of any FN1 characters in a Code 128 or an EAN 128 bar code with a Key Category and value chosen by the user (see FN1 Substitution Values on page [10-9](#) to set the Key Category and Key Value).

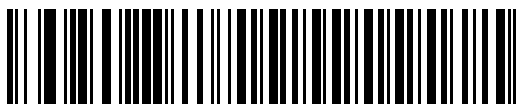

Enable

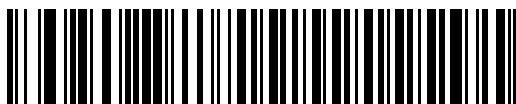

***Disable**

Function Key Mapping

ASCII values under 32 are normally sent as a control-key sequences (see Table 7-2 on page 7-24). When this parameter is enabled, the keys in bold are sent in place of the standard key mapping. Table entries that do not have a bold entry remain the same whether or not this parameter is enabled.



***Disable Function Key Mapping**



Enable Function Key Mapping

Simulated Caps Lock

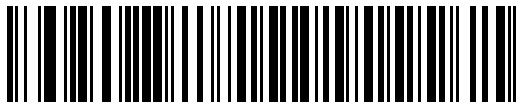

***Disable Simulated Caps Lock**

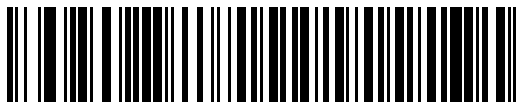

Enable Simulated Caps Lock

Convert Case

When enabled, the scanner will convert all bar code data to the selected case.



***No Case Conversion**

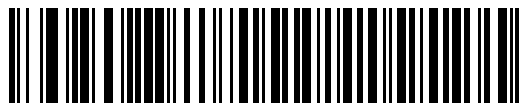

Convert All to Upper Case

Convert Case (Continued)



Convert All to Lower Case

ASCII Character Set

Table 7-2. USB Prefix/Suffix Values

Prefix/ Suffix Value	Full ASCII Code 39 Encode Character	Keystroke
1000	%U	CTRL 2
1001	\$A	CTRL A
1002	\$B	CTRL B
1003	\$C	CTRL C
1004	\$D	CTRL D
1005	\$E	CTRL E
1006	\$F	CTRL F
1007	\$G	CTRL G
1008	\$H	CTRL H/ BACKSPACE ¹
1009	\$I	CTRL I/ HORIZONTAL TAB ¹
1010	\$J	CTRL J
1011	\$K	CTRL K
1012	\$L	CTRL L
1013	\$M	CTRL M/ ENTER ¹
1014	\$N	CTRL N
1015	\$O	CTRL O
1016	\$P	CTRL P
1017	\$Q	CTRL Q
1018	\$R	CTRL R
1019	\$S	CTRL S
1020	\$T	CTRL T
1021	\$U	CTRL U
1022	\$V	CTRL V
1023	\$W	CTRL W
1024	\$X	CTRL X
1025	\$Y	CTRL Y
1026	\$Z	CTRL Z
1027	%A	CTRL [/b>ESC ¹
1028	%B	CTRL \
1029	%C	CTRL]

¹The keystroke in bold is sent only if the "Function Key Mapping" is enabled. Otherwise, the unbolded keystroke is sent.

Table 7-2. USB Prefix/Suffix Values (Continued)

Prefix/ Suffix Value	Full ASCII Code 39 Encode Character	Keystroke
1030	%D	CTRL 6
1031	%E	CTRL -
1032	Space	Space
1033	/A	!
1034	/B	"
1035	/C	#
1036	/D	\$
1037	/E	%
1038	/F	&
1039	/G	'
1040	/H	(
1041	/I)
1042	/J	*
1043	/K	+
1044	/L	,
1045	-	-
1046	.	.
1047	/O	/
1048	0	0
1049	1	1
1050	2	2
1051	3	3
1052	4	4
1053	5	5
1054	6	6
1055	7	7
1056	8	8
1057	9	9
1058	/Z	:
1059	%F	;
1060	%G	<
1061	%H	=
1062	%I	>

¹The keystroke in bold is sent only if the "Function Key Mapping" is enabled. Otherwise, the unbolded keystroke is sent.

Table 7-2. USB Prefix/Suffix Values (Continued)

Prefix/ Suffix Value	Full ASCII Code 39 Encode Character	Keystroke
1063	%J	?
1064	%V	@
1065	A	A
1066	B	B
1067	C	C
1068	D	D
1069	E	E
1070	F	F
1071	G	G
1072	H	H
1073	I	I
1074	J	J
1075	K	K
1076	L	L
1077	M	M
1078	N	N
1079	O	O
1080	P	P
1081	Q	Q
1082	R	R
1083	S	S
1084	T	T
1085	U	U
1086	V	V
1087	W	W
1088	X	X
1089	Y	Y
1090	Z	Z
1091	%K	[
1092	%L	\
1093	%M]
1094	%N	^
1095	%O	_
¹ The keystroke in bold is sent only if the "Function Key Mapping" is enabled. Otherwise, the unbolded keystroke is sent.		

Table 7-2. USB Prefix/Suffix Values (Continued)

Prefix/ Suffix Value	Full ASCII Code 39 Encode Character	Keystroke
1096	%W	`
1097	+A	a
1098	+B	b
1099	+C	c
1100	+D	d
1101	+E	e
1102	+F	f
1103	+G	g
1104	+H	h
1105	+I	i
1106	+J	j
1107	+K	k
1108	+L	l
1109	+M	m
1110	+N	n
1111	+O	o
1112	+P	p
1113	+Q	q
1114	+R	r
1115	+S	s
1116	+T	t
1117	+U	u
1118	+V	v
1119	+W	w
1120	+X	x
1121	+Y	y
1122	+Z	z
1123	%P	{
1124	%Q	
1125	%R	}
1126	%S	~

¹The keystroke in bold is sent only if the "Function Key Mapping" is enabled. Otherwise, the unbolded keystroke is sent.

Table 7-3. USB ALT Key Character Set

ALT Keys	Keystroke
2064	ALT 2
2065	ALT A
2066	ALT B
2067	ALT C
2068	ALT D
2069	ALT E
2070	ALT F
2071	ALT G
2072	ALT H
2073	ALT I
2074	ALT J
2075	ALT K
2076	ALT L
2077	ALT M
2078	ALT N
2079	ALT O
2080	ALT P
2081	ALT Q
2082	ALT R
2083	ALT S
2084	ALT T
2085	ALT U
2086	ALT V
2087	ALT W
2088	ALT X
2089	ALT Y
2090	ALT Z

Table 7-4. USB GUI Key Character Set

GUI Key	Keystroke
3000	Right Control Key
3048	GUI 0
3049	GUI 1
3050	GUI 2
3051	GUI 3
3052	GUI 4
3053	GUI 5
3054	GUI 6
3055	GUI 7
3056	GUI 8
3057	GUI 9
3065	GUI A
3066	GUI B
3067	GUI C
3068	GUI D
3069	GUI E
3070	GUI F
3071	GUI G
3072	GUI H
3073	GUI I
3074	GUI J
3075	GUI K
3076	GUI L
3077	GUI M
3078	GUI N
3079	GUI O
3080	GUI P
3081	GUI Q
3082	GUI R
3083	GUI S
3084	GUI T
3085	GUI U
3086	GUI V
3087	GUI W
<p>Note: GUI Shift Keys - The Apple™ iMac keyboard has an apple key on either side of the space bar. Windows-based systems have a GUI key to the left of the left ALT key, and to the right of the right ALT key.</p>	

Table 7-4. USB GUI Key Character Set (Continued)

GUI Key	Keystroke
3088	GUI X
3089	GUI Y
3090	GUI Z
Note: GUI Shift Keys - The Apple™ iMac keyboard has an apple key on either side of the space bar. Windows-based systems have a GUI key to the left of the left ALT key, and to the right of the right ALT key.	

Table 7-5. USB F Key Character Set

F Keys	Keystroke
5001	F1
5002	F2
5003	F3
5004	F4
5005	F5
5006	F6
5007	F7
5008	F8
5009	F9
5010	F10
5011	F11
5012	F12
5013	F13
5014	F14
5015	F15
5016	F16
5017	F17
5018	F18
5019	F19
5020	F20
5021	F21
5022	F22
5023	F23
5024	F24

Table 7-6. USB Numeric Keypad Character Set

Numeric Keypad	Keystroke
6042	*
6043	+
6044	undefined
6045	-
6046	.
6047	/
6048	0
6049	1
6050	2
6051	3
6052	4
6053	5
6054	6
6055	7
6056	8
6057	9
6058	Enter
6059	Num Lock

Table 7-7. USB Extended Keypad Character Set

Extended Keypad	Keystroke
7001	Break
7002	Delete
7003	PgUp
7004	End
7005	Pg Dn
7006	Pause
7007	Scroll Lock
7008	Backspace
7009	Tab
7010	Print Screen
7011	Insert
7012	Home
7013	Enter
7014	Escape
7015	Up Arrow
7016	Down Arrow
7017	Left Arrow
7018	Right Arrow

8

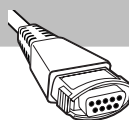

Wand Emulation Interface

Chapter Contents

Introduction	8-3
Connecting Using Wand Emulation	8-3
Wand Emulation Default Parameters	8-4
Wand Emulation Host Parameters	8-5
Wand Emulation Host Types	8-5
Leading Margin (Quiet Zone)	8-7
Polarity	8-9
Ignore Unknown Characters	8-10
Convert All Bar Codes to Code 39	8-11
Convert Code 39 to Full ASCII	8-12

Introduction

This chapter covers Wand Emulation host information for setting up the scanner. This mode is used whenever Wand Emulation communication is needed. The scanner will attach either to an external wand decoder or to a decoder integrated in a portable terminal or Point-of-Sale (POS) terminal.

In this mode the scanner emulates the signal of a digital wand to make it “readable” by a wand decoder.

Throughout the programming bar code menus, default values are indicated with asterisks (*).



Connecting Using Wand Emulation

To perform Wand Emulation, connect the scanner to a portable data terminal, or a controller which collects the wand data and interprets it for the host.

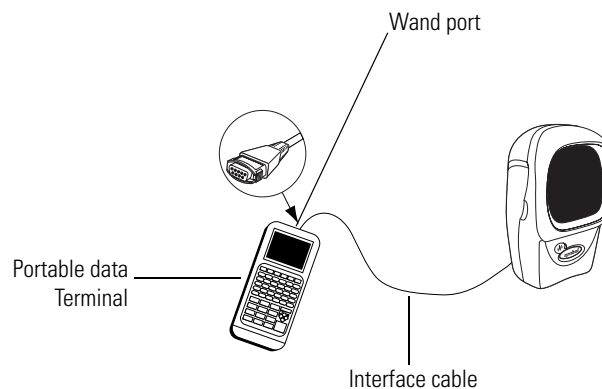
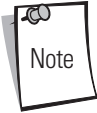

Figure 8-1. Wand Emulation Connection

1. Connect the Wand Emulation interface cable to the rear of the scanner, as described in [Installing the Interface Cable on page 1-4](#).
2. Connect the other end of the interface cable to the Wand port on the portable data terminal or controller.
3. Scan the appropriate bar codes in this chapter to configure the scanner.

Wand Emulation Default Parameters

Table 8-1 lists the defaults for Wand Emulation host types. To change any option, scan the appropriate bar code(s) provided in the Wand Emulation Host Parameters section beginning on page 8-5.



See *Chapter A, Standard Default Parameters* for all user preferences, hosts, symbologies, and miscellaneous default parameters.

Table 8-1. Wand Emulation Default Table

Parameter	Default	Page Number
Wand Emulation Host Parameters		
Wand Emulation Host Types	Symbol OmniLink Interface Controller ¹	8-5
Leading Margin	80 msec	8-7
Polarity	Bar High/Margin Low	8-9
Ignore Unknown Characters	Send Bar Codes	8-10
Convert All Bar Codes to Code 39	Disable	8-11
Convert Code 39 to Full ASCII	Disable	8-12
¹ User selection is required to configure this interface and this is the most common selection.		

Wand Emulation Host Parameters

Wand Emulation Host Types

Select the wand emulation host by scanning one of the bar codes below.

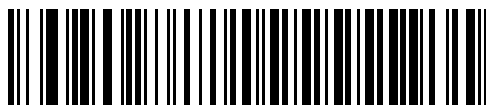

Symbol OmniLink Interface Controller¹

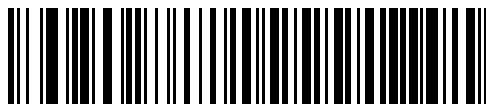

Symbol PDT Terminal (MSI)



¹User selection is required to configure this interface and this is the most common selection.

Wand Emulation Host Types (Continued)



Symbol PTC Terminal (Telxon)

Leading Margin (Quiet Zone)

Scan a bar code below to select a leading margin duration. A leading margin is the time that precedes the first bar of the scan, (in milliseconds). The minimum allowed value is 80 msec and the maximum is 250 msec. This parameter is used to accommodate older wand decoders which cannot handle short leading margins.

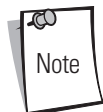

Note

250 msec is the maximum value that this parameter can attain, however, 200 msec is sufficient.

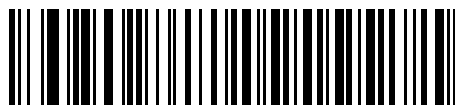

***80 msec**



140 msec

Leading Margin (Quiet Zone) (Continued)

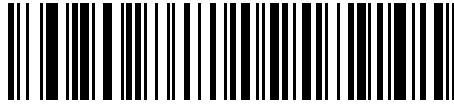

200 msec

Polarity

Polarity determines how the scanner's wand emulation interface creates the Digitized Barcode Pattern (DBP). DBP is a digital signal that represents the scanned bar code. Different decoders, to which this device could be attached, are expecting the DBP to be in a certain format. The DBP either has the "highs" represent bars and the "lows" represent spaces (margins), or the "highs" represent spaces (margins) and the "lows" represent bars.

Scan the appropriate bar code below to select the polarity required by the decoder.



*** Bar High/Margin Low**

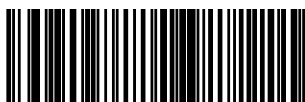

Bar Low/Margin High

Ignore Unknown Characters

Unknown characters are characters the host does not recognize. When **Send Bar Codes With Unknown Characters** is selected, all bar code data is sent except for unknown characters, and no error beeps sound on the scanner. When **Do Not Send Bar Codes With Unknown Characters** is selected, bar codes containing at least one unknown character are not sent to the host, and then an error beep will sound on the scanner.

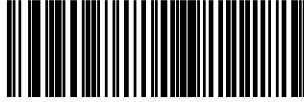

***Send Bar Codes With Unknown Characters**



Do Not Send Bar Codes With Unknown Characters

Convert All Bar Codes to Code 39

By default, the Wand Emulation Interface sends data to the attached host in the same symbology that was decoded. This may present a problem for customers with legacy systems that do not recognize some newer symbologies (for example, RSS).

Enabling this parameter ignores the original symbology that was decoded, and outputs the data as if it were a Code 39 barcode. Any lowercase characters that were in the original data stream are transmitted as uppercase characters. This also allows ADF Formatting to occur.

If Ignore Unknown Characters is enabled, any characters that do not have a corresponding character in the Code 39 symbology set are replaced by a space.

If Ignore Unknown Characters is disabled, if any characters that do not have a corresponding character are encountered, the scanner emits an error beep and no data is transmitted.

ADF Note: By default, the Wand Emulation Interface does not allow scanned data to be processed by ADF rules. Enabling this parameter has the side effect of allowing the scanned data to be processed by the ADF rules (See Chapter 13).



Enable Convert to Code 39 for Wand Host

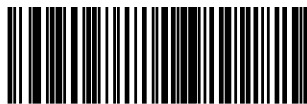

***Disable Convert to Code 39 for Wand Host**

Convert Code 39 to Full ASCII

By default, any characters that do not have a corresponding character in the Code 39 symbology set are replaced by a space. If this parameter is enabled, the data sent to the Wand Interface will be encoded in Code 39 Full ASCII. This setting requires that the Host be able to interpret Code 39 Full ASCII data.

This setting applies only if **Convert to Code 39** is also enabled.

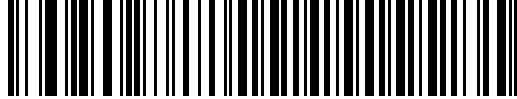

***Disable Code 39 Full ASCII Conversion**



Enable Code 39 Full ASCII Conversion

9

Symbologies

Chapter Contents

Introduction	9-5
Scanning Sequence Examples	9-5
Errors While Scanning	9-5
Symbology Default Parameters	9-6
UPC/EAN	9-9
Enable/Disable UPC-A/UPC-E	9-9
Enable/Disable UPC-E1	9-11
Enable/Disable EAN-13/JAN-13/EAN-8/JAN-8	9-12
Enable/Disable Bookland EAN	9-14
Decode UPC/EAN Supplementals	9-15
UPC/EAN Supplemental Redundancy	9-24
Transmit UPC-A/UPC-E/UPC-E1 Check Digit	9-25
UPC-A Preamble	9-28
UPC-E Preamble	9-30
UPC-E1 Preamble	9-32
Convert UPC-E to UPC-A	9-34
Convert UPC-E1 to UPC-A	9-35
EAN Zero Extend	9-36
Bookland ISBN Format	9-37
UCC Coupon Extended Code	9-38
Linear UPC/EAN Decode	9-39
Code 128	9-40
Enable/Disable Code 128	9-40
Enable/Disable UCC/EAN-128	9-41

Enable/Disable ISBT 128	9-42
Code 128 Decode Performance	9-43
Code 128 Decode Performance Level	9-44
Code 39	9-46
Enable/Disable Code 39	9-46
Enable/Disable Trioptic Code 39	9-47
Convert Code 39 to Code 32	9-48
Code 32 Prefix	9-49
Set Lengths for Code 39	9-50
Code 39 Check Digit Verification	9-52
Transmit Code 39 Check Digit	9-53
Enable/Disable Code 39 Full ASCII	9-54
Code 39 Buffering (Scan & Store)	9-55
Code 39 Decode Performance	9-58
Code 39 Decode Performance Level	9-59
Code 93	9-61
Enable/Disable Code 93	9-61
Set Lengths for Code 93	9-62
Code 11	9-64
Code 11	9-64
Set Lengths for Code 11	9-65
Code 11 Check Digit Verification	9-67
Transmit Code 11 Check Digits	9-69
Interleaved 2 of 5 (ITF)	9-70
Enable/Disable Interleaved 2 of 5	9-70
Set Lengths for Interleaved 2 of 5	9-71
I 2 of 5 Check Digit Verification	9-73
Transmit I 2 of 5 Check Digit	9-75
Convert I 2 of 5 to EAN-13	9-76
Discrete 2 of 5 (DTF)	9-77
Enable/Disable Discrete 2 of 5	9-77
Set Lengths for Discrete 2 of 5	9-78
Chinese 2 of 5	9-80
Enable/Disable Chinese 2 of 5	9-80
Codabar (NW - 7)	9-81
Enable/Disable Codabar	9-81
Set Lengths for Codabar	9-82
CLSI Editing	9-84
NOTIS Editing	9-85
MSI	9-86
Enable/Disable MSI	9-86
Set Lengths for MSI	9-87
MSI Check Digits	9-89
Transmit MSI Check Digit(s)	9-90
MSI Check Digit Algorithm	9-91
RSS (Reduced Space Symbology)	9-92
RSS 14	9-92

RSS Limited 9-93
RSS Expanded..... 9-94
Convert RSS to UPC/EAN..... 9-95
Symbology - Specific Security Levels..... 9-97
 Redundancy Level 9-97
 Security Level 9-99
Symbology - Intercharacter Gap..... 9-101

Introduction

This chapter describes all symbology features and provides the programming bar codes necessary for selecting these features for the Symbol LS9203 scanner. Before programming, follow the instructions in [Chapter 1, Getting Started](#).

The scanner is shipped with the settings shown in the [Symbology Default Table on page 9-6](#) (also see [Chapter A, Standard Default Parameters](#) for all host device and miscellaneous scanner defaults). If the default values suit your requirements, programming may not be necessary. Features values are set by scanning single bar codes or short bar code sequences.

To return all features to their default values, scan the [Set All Defaults](#) bar code on [page 4-5](#).

If using a USB cable, select a host type. Refer to each host chapter for specific host information.

Scanning Sequence Examples

In most cases only scan one bar code to set a specific parameter value. For example, to transmit bar code data without the UPC-A check digit, simply scan the **Do Not Transmit UPC-A Check Digit** bar code listed under [Transmit UPC-A/UPC-E/UPC-E1 Check Digit on page 9-25](#). The scanner issues a short high beep and the LED turns green, signifying a successful parameter entry.

Other parameters, such as **Set Length(s) for D 2 of 5** require scanning several bar codes in the proper sequence. Refer to the individual parameter, like **Set Length(s) for D 2 of 5**, for this procedure.

Errors While Scanning

Unless otherwise specified, if an error is made during a scanning sequence, just re-scan the correct parameter.

Symbology Default Parameters

Table 9-1 lists the defaults for all symbologies parameters. To change any option, scan the appropriate bar code(s) provided in the Symbologies Parameters section beginning on page 9-9.



See [Chapter A, Standard Default Parameters](#) for all user preferences, hosts, symbologies, and miscellaneous default parameters.

Table 9-1. Symbology Default Table

Parameter	Default	Page Number
UPC/EAN		
UPC-A	Enable	9-9
UPC-E	Enable	9-10
UPC-E1	Disable	9-11
EAN-8/JAN-8	Enable	9-13
EAN-13/JAN-13	Enable	9-12
Bookland EAN	Disable	9-14
Decode UPC/EAN Supplementals (2 and 5 digits)	Ignore	9-15
Decode UPC/EAN Supplemental Redundancy	20	9-24
Transmit UPC-A Check Digit	Transmit	9-25
Transmit UPC-E Check Digit	Transmit	9-25
Transmit UPC-E1 Check Digit	Transmit	9-25
UPC-A Preamble	System Character	9-28
UPC-E Preamble	System Character	9-30
UPC-E1 Preamble	System Character	9-32
Convert UPC-E to A	Disable	9-34
Convert UPC-E1 to A	Disable	9-35
EAN-8 Zero Extend	Disable	9-36
Bookland ISBN Format	ISBN-10	9-37
UCC Coupon Extended Code	Disable	9-38
Linear UPC/EAN Decode	Disable	9-39
Code 128		
Code 128	Enable	9-40

Table 9-1. Symbology Default Table (Continued)

Parameter	Default	Page Number
UCC/EAN-128	Enable	9-41
ISBT 128 (non-concatenated)	Enable	9-42
Code 128 Decode Performance	Enable	9-43
Code 128 Decode Performance Level	Level 3	9-44
Code 39		
Code 39	Enable	9-46
Trioptic Code 39	Disable	9-47
Convert Code 39 to Code 32 (Italian Pharmacy Code)	Disable	9-48
Code 32 Prefix	Disable	9-49
Set Length(s) for Code 39	2 to 55	9-50
Code 39 Check Digit Verification	Disable	9-52
Transmit Code 39 Check Digit	Do not transmit	9-53
Code 39 Full ASCII Conversion	Disable	9-54
Buffer Code 39	Disable	9-55
Code 39 Decode Performance	Enable	9-58
Code 39 Decode Performance Level	Level 3	9-59
Code 93		
Code 93	Disable	9-61
Set Length(s) for Code 93	4 to 55	9-62
Code 11		
Code 11	Disable	9-64
Set Lengths for Code 11	4 to 55	9-65
Code 11 Check Digit Verification	Disable	9-67
Transmit Code 11 Check Digit	Do not transmit	9-69
Interleaved 2 of 5 (ITF)		
Interleaved 2 of 5 (ITF)	Disable	9-70
Set Length(s) for I 2 of 5	14	9-71
I 2 of 5 Check Digit Verification	Disable	9-73
Transmit I 2 of 5 Check Digit	Do not transmit	9-75

Table 9-1. Symbology Default Table (Continued)

Parameter	Default	Page Number
Convert I 2 of 5 to EAN 13	Disable	9-76
Discrete 2 of 5 (DTF)		
Discrete 2 of 5	Disable	9-77
Set Length(s) for D 2 of 5	12	9-78
Chinese 2 of 5		
Enable/Disable Chinese 2 of 5	Disable	9-80
Codabar (NW - 7)		
Codabar	Disable	9-81
Set Lengths for Codabar	5 to 55	9-82
CLSI Editing	Disable	9-84
NOTIS Editing	Disable	9-85
MSI		
MSI	Disable	9-86
Set Length(s) for MSI	1 to 55	9-87
MSI Check Digits	One	9-89
Transmit MSI Check Digit	Disable	9-90
MSI Check Digit Algorithm	Mod 10/Mod 10	9-91
RSS (Reduced Space Symbology)		
RSS 14	Enable	9-92
RSS Limited	Disable	9-93
RSS Expanded	Enable	9-94
Convert RSS to UPC/EAN	Disable	9-95
Symbology - Specific Security Levels		
Redundancy Security Levels	1	9-97
Security Level	0	9-99
Symbology - Intercharacter Gap		
Intercharacter Gaps	Normal	9-101

UPC/EAN

Enable/Disable UPC-A/UPC-E

To enable or disable UPC-A or UPC-E, scan the appropriate bar code below.



***Enable UPC-A**



Disable UPC-A

Enable/Disable UPC-A/UPC-E (Continued)



***Enable UPC-E**

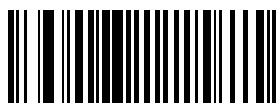

Disable UPC-E

Enable/Disable UPC-E1

To enable or disable UPC-E1, scan the appropriate bar code below.



UPC-E1 is not a UCC (Uniform Code Council) approved symbology.

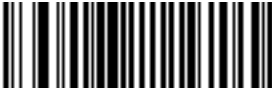

Enable UPC-E1



***Disable UPC-E1**

Enable/Disable EAN-13/JAN-13/EAN-8/JAN-8

To enable or disable EAN-13/JAN-13 or EAN-8/JAN-8, scan the appropriate bar code below.

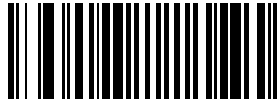

***Enable EAN-13/JAN-13**

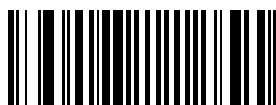

Disable EAN-13/JAN-13

Enable/Disable EAN-13/JAN-13/EAN-8/JAN-8 (Continued)



***Enable EAN-8/JAN-8**

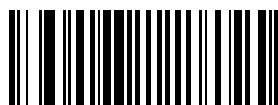

Disable EAN-8/JAN-8

Enable/Disable Bookland EAN

To enable or disable Bookland EAN, scan the appropriate bar code below.



Enable Bookland EAN



***Disable Bookland EAN**



If you enable Bookland EAN, select a [Bookland ISBN Format on page 9-37](#). Also select either Decode UPC/EAN Supplementals, Autodiscriminate UPC/EAN Supplementals, or Enable 978/979 Supplemental Mode in [Decode UPC/EAN Supplementals on page 9-15](#).

Decode UPC/EAN Supplementals

Supplementals are bar codes appended according to specific format conventions (e.g., UPC-A+2, UPC-E+2, EAN 13+2). The following options are available:

- If you select **Ignore UPC/EAN with Supplementals**, and the scanner is presented with a UPC/EAN plus supplemental symbol, the scanner decodes UPC/EAN and ignores the supplemental characters.
- If you select **Decode UPC/EAN with Supplementals**, the scanner only decodes UPC/EAN symbols with supplemental characters, and ignores symbols without supplementals.
- If you select **Autodiscriminate UPC/EAN Supplementals**, the scanner decodes UPC/EAN symbols with supplemental characters immediately. If the symbol does not have a supplemental, the scanner must decode the bar code the number of times set via [UPC/EAN Supplemental Redundancy on page 9-24](#) before transmitting its data to confirm that there is no supplemental.
- If you select one of the following **Supplemental Mode** options, the scanner immediately transmits EAN-13 bar codes starting with that prefix that have supplemental characters. If the symbol does not have a supplemental, the scanner must decode the bar code the number of times set via [UPC/EAN Supplemental Redundancy on page 9-24](#) before transmitting its data to confirm that there is no supplemental. The scanner transmits UPC/EAN bar codes that do not have that prefix immediately.
 - **Enable 378/379 Supplemental Mode**
 - **Enable 978/979 Supplemental Mode**



Note

If you select 978/979 Supplemental Mode and are scanning Bookland EAN bar codes, see [Enable/Disable Bookland EAN on page 9-14](#) to enable Bookland EAN, and select a format using [Bookland ISBN Format on page 9-37](#).

- **Enable 977 Supplemental Mode**
- **Enable 414/419/434/439 Supplemental Mode**
- **Enable 491 Supplemental Mode**
- **Enable Smart Supplemental Mode** - applies to EAN-13 bar codes starting with any prefix listed previously.
- **Supplemental User-Programmable Type 1** - applies to EAN-13 bar codes starting with a 3-digit user-defined prefix. Set this 3-digit prefix using **Supplemental User-Programmable 1**.
- **Supplemental User-Programmable Type 1 and 2** - applies to EAN-13 bar codes starting with either of two 3-digit user-defined prefixes. Set the 3-digit prefixes using **Supplemental User-Programmable 1** and **Supplemental User-Programmable 2**.
- **Smart Supplemental Plus User-Programmable 1** - applies to EAN-13 bar codes starting with any prefix listed previously or the user-defined prefix set using **Supplemental User-Programmable 1**.
- **Smart Supplemental Plus User-Programmable 1 and 2** - applies to EAN-13 bar codes starting with any prefix listed previously or one of the two user-defined prefixes set using **Supplemental User-Programmable 1** and **Supplemental User-Programmable 2**.
- Select **Supplemental User-Programmable 1** to set a 3-digit prefix. Then select the 3 digits using the numeric bar codes beginning on page [D-1](#).
- Select **Supplemental User-Programmable 2** to set a second 3-digit prefix. Then select the 3 digits using the numeric bar codes beginning on page [D-1](#).



Note

To minimize the risk of invalid data transmission, select either to decode or ignore supplemental characters.

Decode UPC/EAN Supplementals (Continued)



***Ignore UPC/EAN With Supplementals**



Decode UPC/EAN Only With Supplementals

Decode UPC/EAN Supplementals (Continued)



Autodiscriminate UPC/EAN Supplementals



Enable 378/379 Supplemental Mode

Decode UPC/EAN Supplementals (Continued)



Enable 978/979 Supplemental Mode



Enable 977 Supplemental Mode

Decode UPC/EAN Supplementals (Continued)



Enable 414/419/434/439 Supplemental Mode



Enable 491 Supplemental Mode

Decode UPC/EAN Supplementals (Continued)



Enable Smart Supplemental Mode

Decode UPC/EAN Supplementals (Continued)



Supplemental User-Programmable Type 1



Supplemental User-Programmable Type 1 and 2

Decode UPC/EAN Supplementals (Continued)



Smart Supplemental Plus User-Programmable 1



Smart Supplemental Plus User-Programmable 1 and 2

Decode UPC/EAN Supplementals (Continued)

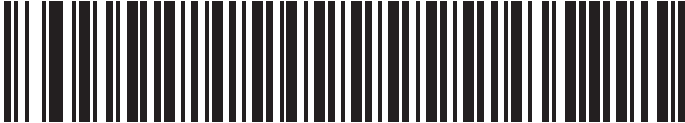

Supplemental User-Programmable 1



Supplemental User-Programmable 2

UPC/EAN Supplemental Redundancy

With **Autodiscriminate UPC/EAN Supplementals** or one of the supplemental modes selected, this option adjusts the number of times a symbol without supplementals is decoded before transmission. The range is from two to thirty times. Five or above is recommended when decoding a mix of UPC/EAN symbols with and without supplementals, and the autodiscriminate option is selected. The default is set at 20.

Scan the bar code below to set a decode redundancy value. Next, scan two numeric bar codes beginning on page [D-1](#) in [Appendix D, Numeric Bar Codes](#). Single digit numbers must have a leading zero. If an error is made, or to change a selection, scan **Cancel** on page [D-8](#).

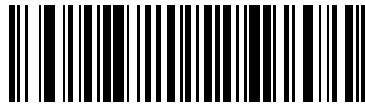

UPC/EAN Supplemental Redundancy

Transmit UPC-A/UPC-E/UPC-E1 Check Digit

The check digit is the last character of the symbol used to verify the integrity of the data. Scan the appropriate bar code below to transmit the bar code data with or without the UPC-A, UPC-E or UPC-E1 check digit. It is always verified to guarantee the integrity of the data.



***Transmit UPC-A Check Digit**



Do Not Transmit UPC-A Check Digit

Transmit UPC-A/UPC-E/UPC-E1 Check Digit (Continued)



***Transmit UPC-E Check Digit**

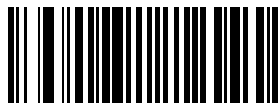

Do Not Transmit UPC-E Check Digit

Transmit UPC-A/UPC-E/UPC-E1 Check Digit (Continued)



***Transmit UPC-E1 Check Digit**



Do Not Transmit UPC-E1 Check Digit

UPC-A Preamble

Preamble characters are part of the UPC symbol consisting of Country Code and System Character. Three options are given for transmitting UPC-A preamble to the host device: transmit System Character only, transmit System Character and Country Code ("0" for USA), and no preamble transmitted. Select the appropriate option to match the host system.



No Preamble
(<DATA>)



***System Character**
(<SYSTEM CHARACTER> <DATA>)

UPC-A Preamble (Continued)

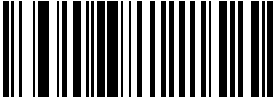

System Character & Country Code
(< COUNTRY CODE> <SYSTEM CHARACTER> <DATA>)

UPC-E Preamble

Preamble characters are part of the UPC symbol consisting of Country Code and System Character. Three options are given for transmitting UPC-E preamble to the host device: transmit System Character only, transmit System Character and Country Code ("0" for USA), and no preamble transmitted. Select the appropriate option to match the host system.

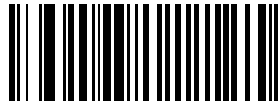

No Preamble
(<DATA>)

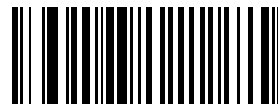

***System Character**
(<SYSTEM CHARACTER> <DATA>)

UPC-E Preamble (Continued)



System Character & Country Code
(< COUNTRY CODE> <SYSTEM CHARACTER> <DATA>)

UPC-E1 Preamble

Preamble characters are part of the UPC symbol consisting of Country Code and System Character. Three options are given for transmitting UPC-E1 preamble to the host device: transmit System Character only, transmit System Character and Country Code ("0" for USA), and no preamble transmitted. Select the appropriate option to match the host system.



No Preamble
(<DATA>)



***System Character**
(<SYSTEM CHARACTER> <DATA>)

UPC-E1 Preamble (Continued)



System Character & Country Code
(< COUNTRY CODE> <SYSTEM CHARACTER> <DATA>)

Convert UPC-E to UPC-A

When enabled, UPC-E (zero suppressed) decoded data is converted to UPC-A format before transmission. After conversion, the data follows UPC-A format and is affected by UPC-A programming selections (e.g., Preamble, Check Digit).

When disabled, UPC-E decoded data is transmitted as UPC-E data, without conversion.



**Convert UPC-E to UPC-A
(Enable)**

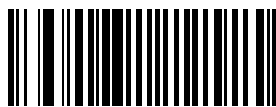

***Do Not Convert UPC-E to UPC-A
(Disable)**

Convert UPC-E1 to UPC-A

When enabled, UPC-E1 decoded data is converted to UPC-A format before transmission. After conversion, the data follows UPC-A format and is affected by UPC-A programming selections (e.g., Preamble, Check Digit).

When disabled, UPC-E1 decoded data is transmitted as UPC-E1 data, without conversion.



**Convert UPC-E1 to UPC-A
(Enable)**



***Do Not Convert UPC-E1 to UPC-A
(Disable)**

EAN Zero Extend

When enabled, this parameter adds five leading zeros to decoded EAN-8 symbols to make them compatible in format to EAN-13 symbols.

When disabled, EAN-8 symbols are transmitted as is.

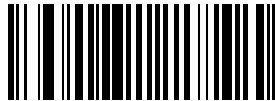

Enable EAN Zero Extend

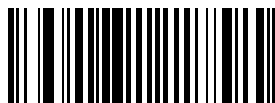

***Disable EAN Zero Extend**

Bookland ISBN Format

If you enabled Bookland EAN using [Enable/Disable Bookland EAN on page 9-14](#), select one of the following formats for Bookland data:

- **Bookland ISBN-10** - The scanner reports Bookland data starting with 978 in traditional 10-digit format with the special Bookland check digit for backward-compatibility. Data starting with 979 is not considered Bookland in this mode.
- **Bookland ISBN-13** - The scanner reports Bookland data (starting with either 978 or 979) as EAN-13 in 13-digit format to meet the 2007 ISBN-13 protocol.



***Bookland ISBN-10**



Bookland ISBN-13



Note

For Bookland EAN to function properly, first enable Bookland EAN using [Enable/Disable Bookland EAN on page 9-14](#), then select either Decode UPC/EAN Supplementals, Autodiscriminate UPC/EAN Supplementals, or Enable 978/979 Supplemental Mode in [Decode UPC/EAN Supplementals on page 9-15](#).

UCC Coupon Extended Code

The UCC Coupon Extended Code is an additional bar code adjacent to a UCC Coupon Code. To enable or disable UCC Coupon Extended Code, scan the appropriate bar code below.



Enable UCC Coupon Extended Code



***Disable UCC Coupon Extended Code**

Linear UPC/EAN Decode

This option applies to code types containing two adjacent blocks (e.g., UPC-A, EAN-8, EAN-13). When enabled, a bar code is transmitted only when both the left and right blocks are successfully decoded within one laser scan. Enable this option when bar codes are in proximity to each other.



Enable Linear UPC/EAN Decode



***Disable Linear UPC/EAN Decode**

Code 128

Enable/Disable Code 128

To enable or disable Code 128, scan the appropriate bar code below.

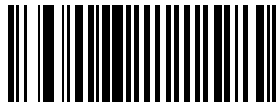

***Enable Code 128**

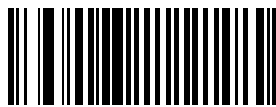

Disable Code 128

Enable/Disable UCC/EAN-128

To enable or disable UCC/EAN-128, scan the appropriate bar code below.



***Enable UCC/EAN-128**

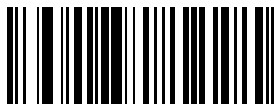

Disable UCC/EAN-128

Enable/Disable ISBT 128

ISBT 128 is a variant of Code 128 used in the blood banking industry. To enable or disable ISBT 128, scan the appropriate bar code below. Concatenation of the ISBT data, if required, must be performed in the host.

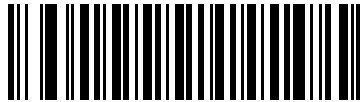

***Enable ISBT 128**

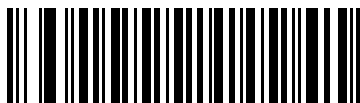

Disable ISBT 128

Code 128 Decode Performance

This option offers three levels of decode performance or “aggressiveness” for Code 128 symbols. Increasing the performance level reduces the amount of required bar code orientation, which is useful when scanning very long and/or truncated bar codes. Increased levels reduce decode security.

If this option is enabled, select a Decode Performance level from the following pages to suit the performance needs.



***Enable Code 128 Decode Performance**



Disable Code 128 Decode Performance

Code 128 Decode Performance Level

This option offers three levels of decode performance or “aggressiveness” for Code 128 symbols. Increasing the performance level reduces the amount of required bar code orientation, which is useful when scanning very long and/or truncated bar codes. Increased levels reduce decode security.

This option must be enabled (see Code 128 Decode Performance Enable).



Code 128 Decode Performance Level 1



Code 128 Decode Performance Level 2

Code 128 Decode Performance Level (Continued)



***Code 128 Decode Performance Level 3**

Code 39

Enable/Disable Code 39

To enable or disable Code 39, scan the appropriate bar code below.

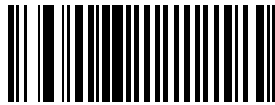

***Enable Code 39**

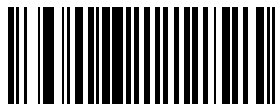

Disable Code 39



When a large gap bar code is encountered, refer to [Symbology - Intercharacter Gap on page 9-101](#)

Enable/Disable Trioptic Code 39

Trioptic Code 39 is a variant of Code 39 used in the marking of computer tape cartridges. Trioptic Code 39 symbols always contain six characters. To enable or disable Trioptic Code 39, scan the appropriate bar code below.



Enable Trioptic Code 39



***Disable Trioptic Code 39**



Note

Trioptic Code 39 and Code 39 Full ASCII should not be enabled simultaneously.

Convert Code 39 to Code 32

Code 32 is a variant of Code 39 used by the Italian pharmaceutical industry. Scan the appropriate bar code below to enable or disable converting Code 39 to Code 32.



Code 39 must be enabled in order for this parameter to function.



Enable Convert Code 39 to Code 32



***Disable Convert Code 39 to Code 32**

Code 32 Prefix

Scan the appropriate bar code below to enable or disable adding the prefix character "A" to all Code 32 bar codes.

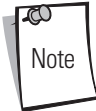

Convert Code 39 to Code 32 must be enabled for this parameter to function.



Enable Code 32 Prefix



***Disable Code 32 Prefix**

Set Lengths for Code 39

The length of a code refers to the number of characters (i.e., human readable characters), including check digit(s) the code contains. Lengths for Code 39 may be set for any length, one or two discrete lengths, or lengths within a specific range. If Code 39 Full ASCII is enabled, **Length Within a Range** or **Any Length** are the preferred options.

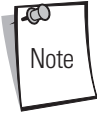

When setting lengths for different bar code types by scanning single digit numbers, single digit numbers must always be preceded by a leading zero.

One Discrete Length - This option allows the scanner to decode only those Code 39 symbols containing a selected length. Lengths are selected from the numeric bar codes beginning on page [D-1](#). For example, to decode only Code 39 symbols with 14 characters, scan **Code 39 - One Discrete Length**, then scan **1** followed by **4**. If an error is made or to change a selection, scan **Cancel** on page [D-8](#).



Code 39 - One Discrete Length

Two Discrete Lengths - This option allows the scanner to decode only those Code 39 symbols containing either of two selected lengths. Lengths are selected from the numeric bar codes beginning on page [D-1](#) in [Appendix D, Numeric Bar Codes](#). For example, to decode only those Code 39 symbols containing either 2 or 14 characters, select **Code 39 - Two Discrete Lengths**, then scan **0, 2, 1**, and then **4**. If an error is made or to change a selection, scan **Cancel** on page [D-8](#).

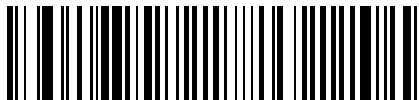

Code 39 - Two Discrete Lengths

Set Lengths for Code 39 (Continued)

Length Within Range - This option allows the scanner to decode a Code 39 symbol with a specific length range. The length range is selected from numeric bar codes beginning on page D-1 in [Appendix D, Numeric Bar Codes](#). For example, to decode Code 39 symbols containing between 4 and 12 characters, first scan **Code 39 - Length Within Range**. Then scan **0, 4, 1,** and **2** (single digit numbers must always be preceded by a leading zero). If an error is made or to change a selection, scan **Cancel** on page D-8.



Code 39 - Length Within Range

Any Length - Scanning this option allows the scanner to decode Code 39 symbols containing any number of characters within the scanner capability.



Code 39 - Any Length

Code 39 Check Digit Verification

When this feature is enabled, the scanner checks the integrity of all Code 39 symbols to verify that the data complies with specified check digit algorithm. Only those Code 39 symbols which include a modulo 43 check digit are decoded when this feature is enabled. This feature should only be enabled if the code 39 symbols contain a modulo 43 check digit.

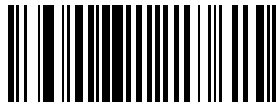

Enable Code 39 Check Digit

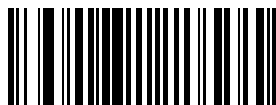

***Disable Code 39 Check Digit**

Transmit Code 39 Check Digit

Scan a bar code below to transmit Code 39 data with or without the check digit.



**Transmit Code 39 Check Digit
(Enable)**



***Do Not Transmit Code 39 Check Digit
(Disable)**



Note

Code 39 Check Digit Verification must be enabled for this parameter to function.

Enable/Disable Code 39 Full ASCII

Code 39 Full ASCII is a variant of Code 39 which pairs characters to encode the full ASCII character set. To enable or disable Code 39 Full ASCII, scan the appropriate bar code below.

Code 39 Full ASCII to Full ASCII Correlation is host-dependent, and therefore described in the "ASCII Character Set" Table for the appropriate interface.



Enable Code 39 Full ASCII



***Disable Code 39 Full ASCII**



Trioptic Code 39 and Code 39 Full ASCII should not be enabled simultaneously.

Code 39 Buffering (Scan & Store)

This feature allows the scanner to accumulate data from multiple Code 39 symbols.

When the Scan and Store option (Buffer Code 39) is selected, all Code 39 symbols having a leading space as a first character are temporarily buffered in the unit to be transmitted later. The leading space is not buffered.

Decode of a valid Code 39 symbol with no leading space causes transmission in sequence of all buffered data in a first-in first-out format, plus transmission of the “triggering” symbol. See the following pages for further details.

When the **Do Not Buffer Code 39** option is selected, all decoded Code 39 symbols are transmitted immediately without being stored in the buffer.

This feature affects Code 39 only. If **Buffer Code 39** is selected, it is recommend to configure the scanner to decode Code 39 symbology only.



**Buffer Code 39
(Enable)**



***Do Not Buffer Code 39**

While there is data in the transmission buffer, selecting **Do Not Buffer Code 39** is not allowed. The buffer holds 200 bytes of information.

To disable Code 39 buffering when there is data in the transmission buffer, first force the buffer transmission (see [Transmit Buffer on page 9-56](#)) or clear the buffer.

Buffer Data

To buffer data, Code 39 buffering must be enabled and a Code 39 symbol must be read with a space immediately following the start pattern.

- Unless the data overflows the transmission buffer, the scanner issues a lo/hi beep to indicate successful decode and buffering. (For overflow conditions, see [Overfilling Transmission Buffer on page 9-57.](#))
- The scanner adds the decoded data excluding the leading space to the transmission buffer.
- No transmission occurs.

Clear Transmission Buffer

To clear the transmission buffer, scan the **Clear Buffer** bar code below, which contains only a start character, a dash (minus), and a stop character.

- The scanner issues a short hi/lo/hi beep.
- The scanner erases the transmission buffer.
- No transmission occurs.



Clear Buffer



The Clear Buffer contains only the dash (minus) character. In order to scan this command, be sure Code 39 length is set to include length 1.

Transmit Buffer

There are two methods to transmit the Code 39 buffer.

1. Scan the **Transmit Buffer** bar code below. Only a start character, a plus (+), and a stop character.
 - The scanner transmits and clears the buffer.
 - The scanner issues a lo/hi beep.



Transmit Buffer

2. Scan a Code 39 bar code with a leading character other than a space.
 - The scanner issues a hi/lo beep to indicate a good decode and that buffering of the decode data has occurred.
 - The scanner transmits and clears the buffer.
 - The scanner signals that the buffer was transmitted with a lo/hi beep.



The Transmit Buffer contains only a plus (+) character. In order to scan this command, be sure Code 39 length is set to include length 1.

Overfilling Transmission Buffer

The Code 39 buffer holds 200 characters. If the symbol just read results in an overflow of the transmission buffer:

- The scanner indicates that the symbol was rejected by issuing three long, high beeps.
- No transmission occurs. The data in the buffer is not affected.

Attempt to Transmit an Empty Buffer

If the symbol just read was the **Transmit Buffer** symbol and the Code 39 buffer is empty:

- A short lo/hi/lo beep signals that the buffer is empty.
- No transmission occurs.
- The buffer remains empty.

Code 39 Decode Performance

This option offers three levels of decode performance or “aggressiveness” for Code 39 symbols. Increasing the performance level reduces the amount of required bar code orientation, which is useful when scanning very long and/or truncated bar codes. Increased levels reduce decode security.

If this option is enabled, select a Decode Performance level from the following pages to suit performance needs.



This option only works with Code 39 One Discrete Length.



***Enable Code 39 Decode Performance**



Disable Code 39 Decode Performance

Code 39 Decode Performance Level

This option offers three levels of decode performance or “aggressiveness” for Code 39 symbols. Increasing the performance level reduces the amount of required bar code orientation, which is useful when scanning very long and/or truncated bar codes. Increased levels reduce decode security.

This option must be enabled (see Code 39 Decode Performance).



Code 39 Decode Performance Level 1



Code 39 Decode Performance Level 2

Code 39 Decode Performance Level (Continued)



***Code 39 Decode Performance Level 3**

Code 93

Enable/Disable Code 93

To enable or disable Code 93, scan the appropriate bar code below.



Enable Code 93



***Disable Code 93**

Set Lengths for Code 93

The length of a code refers to the number of characters (i.e., human readable characters), including check digit(s) the code contains. Lengths for Code 93 may be set for any length, one or two discrete lengths, or lengths within a specific range. discrete lengths, or lengths within a specific range.

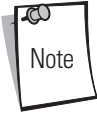

When setting lengths for different bar code types by scanning single digit numbers, single digit numbers must always be preceded by a leading zero.

One Discrete Length - This option allows the scanner to decode only those Code 93 symbols containing a selected length. Lengths are selected from the numeric bar codes beginning on page [D-1](#) in [Appendix D, Numeric Bar Codes](#). For example, to decode only Code 93 symbols with 14 characters, scan **Code 93 - One Discrete Length**, then scan **1** followed by **4**. If an error is made or to change a selection, scan **Cancel** on page [D-8](#).



Code 93 - One Discrete Length

Two Discrete Lengths - This option allows the scanner to decode only those Code 93 symbols containing either of two selected lengths. Lengths are selected from the numeric bar codes beginning on page [D-1](#) in [Appendix D, Numeric Bar Codes](#). For example, to decode only those Code 93 symbols containing either 2 or 14 characters, select **Code 93 - Two Discrete Lengths**, then scan **0, 2, 1**, and then **4**. If an error is made or to change a selection, scan **Cancel** on page [D-8](#).



Code 93 - Two Discrete Lengths

Set Lengths for Code 93 (Continued)

Length Within Range - This option allows the scanner to decode a Code 93 symbol with a specific length range. The length range is selected from numeric bar codes beginning on page [D-1](#) in [Appendix D, Numeric Bar Codes](#). For example, to decode Code 93 symbols containing between 4 and 12 characters, first scan **Code 93 - Length Within Range**. Then scan **0, 4, 1,** and **2** (single digit numbers must always be preceded by a leading zero). If an error is made or to change a selection, scan **Cancel** on page [D-8](#).



Code 93 - Length Within Range

Any Length - Scanning this option allows the scanner to decode Code 93 symbols containing any number of characters within the scanner's capability.



Code 93 - Any Length

Code 11

Code 11

To enable or disable Code 11, scan the appropriate bar code below.

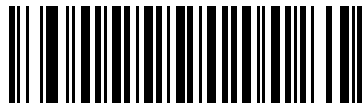

Enable Code 11



***Disable Code 11**

Set Lengths for Code 11

The length of a code refers to the number of characters (i.e., human readable characters), including check digit(s) the code contains. Lengths for Code 11 may be set for any length, one or two discrete lengths, or lengths within a specific range. discrete lengths, or lengths within a specific range.



When setting lengths for different bar code types by scanning single digit numbers, single digit numbers must always be preceded by a leading zero.

One Discrete Length - This option allows the scanner to decode only those Code 11 symbols containing a selected length. Lengths are selected from the numeric bar codes beginning on page [D-1](#) in [Appendix D, Numeric Bar Codes](#). For example, to decode only Code 11 symbols with 14 characters, scan **Code 11 - One Discrete Length**, then scan **1** followed by **4**. If an error is made or to change a selection, scan **Cancel** on page [D-8](#).



Code 11 - One Discrete Length

Two Discrete Lengths - This option allows the scanner to decode only those Code 11 symbols containing either of two selected lengths. Lengths are selected from the numeric bar codes beginning on page [D-1](#) in [Appendix D, Numeric Bar Codes](#). For example, to decode only those Code 11 symbols containing either 2 or 14 characters, select **Code 11 - Two Discrete Lengths**, then scan **0, 2, 1**, and then **4**. If an error is made or to change a selection, scan **Cancel** on page [D-8](#).



Code 11 - Two Discrete Lengths

Set Lengths for Code 11 (Continued)

Length Within Range - This option allows the scanner to decode a Code 11 symbol with a specific length range. The length range is selected from numeric bar codes beginning on page D-1 in [Appendix D, Numeric Bar Codes](#). For example, to decode Code 11 symbols containing between 4 and 12 characters, first scan **Code 11 - Length Within Range**. Then scan **0, 4, 1,** and **2** (single digit numbers must always be preceded by a leading zero). If an error is made or to change a selection, scan **Cancel** on page D-8.



Code 11 - Length Within Range

Any Length - Scanning this option allows the scanner to decode Code 11 symbols containing any number of characters within the scanner capability.



Code 11 - Any Length

Code 11 Check Digit Verification

This feature allows the scanner to check the integrity of all Code 11 symbols to verify that the data complies with the specified check digit algorithm. This selects the check digit mechanism for the decoded Code 11 bar code. The options are to check for one check digit, check for two check digits, or disable the feature.

To enable this feature, scan the bar code below corresponding to the number of check digits encoded in the Code 11 symbols.

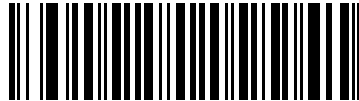

***Disable**



One Check Digit

Code 11 Check Digit Verification (Continued)

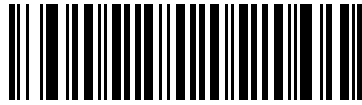

Two Check Digits

Transmit Code 11 Check Digits

This feature selects whether or not to transmit the Code 11 check digit(s).



**Transmit Code 11 Check Digit
(Enable)**

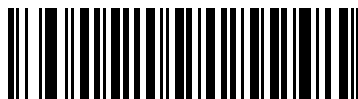

***Do Not Transmit Code 11 Check Digit
(Disable)**

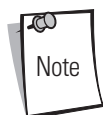

Note

Code 11 Check Digit Verification must be enabled for this parameter to function.

Interleaved 2 of 5 (ITF)

Enable/Disable Interleaved 2 of 5

To enable or disable Interleaved 2 of 5, scan the appropriate bar code below, and select an Interleaved 2 of 5 length from the following pages.



Enable Interleaved 2 of 5



***Disable Interleaved 2 of 5**

Set Lengths for Interleaved 2 of 5

The length of a code refers to the number of characters (i.e., human readable characters), including check digit(s) the code contains. Lengths for I 2 of 5 may be set for any length, one or two discrete lengths, or lengths within a specific range.



When setting lengths for different bar code types by scanning single digit numbers, single digit numbers must always be preceded by a leading zero.

One Discrete Length - This option allows the scanner to decode only those I 2 of 5 symbols containing a selected length. Lengths are selected from the numeric bar codes beginning on page [D-1](#) in [Appendix D, Numeric Bar Codes](#). For example, to decode only I 2 of 5 symbols with 14 characters, scan **I 2 of 5 - One Discrete Length**, then scan **1** followed by **4**. If an error is made or to change a selection, scan **Cancel** on page [D-8](#).



I 2 of 5 - One Discrete Length

Two Discrete Lengths - This option allows the scanner to decode only those I 2 of 5 symbols containing either of two selected lengths. Lengths are selected from the numeric bar codes beginning on page [D-1](#) in [Appendix D, Numeric Bar Codes](#). For example, to decode only those I 2 of 5 symbols containing either 2 or 14 characters, select **I 2 of 5 - Two Discrete Lengths**, then scan **0**, **2**, **1**, and then **4**. If an error is made or to change a selection, scan **Cancel** on page [D-8](#).



I 2 of 5 - Two Discrete Lengths

Set Lengths for Interleaved 2 of 5 (Continued)

Length Within Range - This option allows the scanner to decode an I 2 of 5 symbol with a specific length range. The length range is selected from numeric bar codes beginning on page D-1 in [Appendix D, Numeric Bar Codes](#). For example, to decode I 2 of 5 symbols containing between 4 and 12 characters, first scan **I 2 of 5 - Length Within Range**. Then scan **0, 4, 1, and 2** (single digit numbers must always be preceded by a leading zero). If an error is made or to change a selection, scan **Cancel** on page D-8.



I 2 of 5 - Length Within Range

Any Length - Scanning this option allows the scanner to decode I 2 of 5 symbols containing any number of characters within the scanner capability.



Due to the construction of the I 2 of 5 symbology, it is possible for a scan line covering only a portion of the code to be interpreted as a complete scan, yielding less data than is actually encoded in the bar code. To prevent this from happening, it is recommended that specific lengths (**I 2 of 5 - One Discrete Length - Two Discrete Lengths**) be selected for I 2 of 5 applications.



I 2 of 5 - Any Length

12 of 5 Check Digit Verification

When this feature is enabled, the scanner checks the integrity of all 12 of 5 symbols to verify the data complies with either the specified Uniform Symbology Specification (USS), or the Optical Product Code Council (OPCC) check digit algorithm.



***Disable**



USS Check Digit

12 of 5 Check Digit Verification (Continued)



OPCC Check Digit

Transmit I 2 of 5 Check Digit

Scan the appropriate bar code below to transmit I 2 of 5 data with or without the check digit.

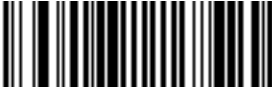

**Transmit I 2 of 5 Check Digit
(Enable)**

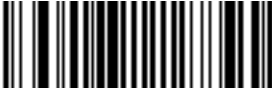

***Do Not Transmit I 2 of 5 Check Digit
(Disable)**

Convert I 2 of 5 to EAN-13

This parameter converts a 14 character I 2 of 5 code into EAN-13, and transmits to the host as EAN-13. In order to accomplish this, the I 2 of 5 code must be enabled, and the code must have a leading zero and a valid EAN-13 check digit.

Scanning a single bar code below, **Convert I 2 of 5 to EAN-13 (Enable)**, accomplishes this function.



**Convert I 2 of 5 to EAN-13
(Enable)**



***Do Not Convert I 2 of 5 to EAN-13
(Disable)**

Discrete 2 of 5 (DTF)

Enable/Disable Discrete 2 of 5

To enable or disable Discrete 2 of 5, scan the appropriate bar code below.



Enable Discrete 2 of 5



***Disable Discrete 2 of 5**

Set Lengths for Discrete 2 of 5

The length of a code refers to the number of characters (i.e., human readable characters), including check digit(s) the code contains. Lengths for D 2 of 5 may be set for any length, one or two discrete lengths, or lengths within a specific range.

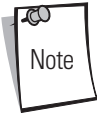

When setting lengths for different bar code types by scanning single digit numbers, single digit numbers must always be preceded by a leading zero.

One Discrete Length - This option allows the scanner to decode only those D 2 of 5 symbols containing a selected length. Lengths are selected from the numeric bar codes beginning on page [D-1](#) in [Appendix D, Numeric Bar Codes](#). For example, to decode only D 2 of 5 symbols with 14 characters, scan **D 2 of 5 - One Discrete Length**, then scan **1** followed by **4**. If an error is made or to change a selection, scan **Cancel** on page [D-8](#).



D 2 of 5 - One Discrete Length

Two Discrete Lengths - This option allows the scanner to decode only those D 2 of 5 symbols containing either of two selected lengths. Lengths are selected from the numeric bar codes beginning on page [D-1](#) in [Appendix D, Numeric Bar Codes](#). For example, to decode only those D 2 of 5 symbols containing either 2 or 14 characters, select **D 2 of 5 - Two Discrete Lengths**, then scan **0, 2, 1**, and then **4**. If an error is made or to change a selection, scan **Cancel** on page [D-8](#).



D 2 of 5 - Two Discrete Lengths

Set Lengths for Discrete 2 of 5 (Continued)

Length Within Range - This option allows the scanner to decode an D 2 of 5 symbol with a specific length range. The length range is selected from numeric bar codes beginning on page D-1 in [Appendix D, Numeric Bar Codes](#). For example, to decode D 2 of 5 symbols containing between 4 and 12 characters, first scan **D 2 of 5 - Length Within Range**. Then scan **0, 4, 1,** and **2** (single digit numbers must always be preceded by a leading zero). If an error is made or to change a selection, scan **Cancel** on page D-8.



D 2 of 5 - Length Within Range

Any Length - Scanning this option allows the scanner to decode D 2 of 5 symbols containing any number of characters within the scanner capability.

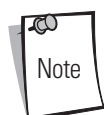

Due to the construction of the D 2 of 5 symbology, it is possible for a scan line covering only a portion of the code to be interpreted as a complete scan, yielding less data than is actually encoded in the bar code. To prevent this from happening, it is recommended that specific lengths (**D 2 of 5 - One Discrete Length - Two Discrete Lengths**) be selected for D 2 of 5 applications.



D 2 of 5 - Any Length

Chinese 2 of 5

Enable/Disable Chinese 2 of 5

To enable or disable Chinese 2 of 5, scan the appropriate bar code below.



Enable Chinese 2 of 5



***Disable Chinese 2 of 5**

Codabar (NW - 7)

Enable/Disable Codabar

To enable or disable Codabar, scan the appropriate bar code below.

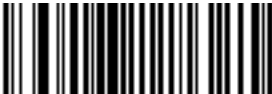

Enable Codabar

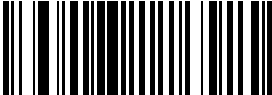

***Disable Codabar**



When a large gap bar code is encountered, refer to [Symbology - Intercharacter Gap on page 9-101](#)

Set Lengths for Codabar

The length of a code refers to the number of characters (i.e., human readable characters), including check digit(s) the code contains. Lengths for Codabar may be set for any length, one or two discrete lengths, or lengths within a specific range.



When setting lengths for different bar code types by scanning single digit numbers, single digit numbers must always be preceded by a leading zero.

One Discrete Length - This option allows the scanner to decode only those Codabar symbols containing a selected length. Lengths are selected from the numeric bar codes beginning on page [D-1](#) in [Appendix D, Numeric Bar Codes](#). For example, to decode only Codabar symbols with 14 characters, scan **Codabar - One Discrete Length**, then scan **1** followed by **4**. If an error is made or to change a selection, scan **Cancel** on page [D-8](#).



Codabar - One Discrete Length

Two Discrete Lengths - This option allows the scanner to decode only those Codabar symbols containing either of two selected lengths. Lengths are selected from the numeric bar codes beginning on page [D-1](#) in [Appendix D, Numeric Bar Codes](#). For example, to decode only those Codabar symbols containing either 2 or 14 characters, select **Codabar - Two Discrete Lengths**, then scan **0, 2, 1**, and then **4**. If an error is made or to change a selection, scan **Cancel** on page [D-8](#).



Codabar - Two Discrete Lengths

Set Lengths for Codabar (Continued)

Length Within Range - This option allows the scanner to decode a Codabar symbol with a specific length range. The length range is selected from numeric bar codes beginning on page D-1 in [Appendix D, Numeric Bar Codes](#). For example, to decode Codabar symbols containing between 4 and 12 characters, first scan **Codabar - Length Within Range**. Then scan **0, 4, 1, and 2** (single digit numbers must always be preceded by a leading zero). If an error is made or to change a selection, scan **Cancel** on page D-8.



Codabar - Length Within Range

Any Length - Scanning this option allows the scanner to decode Codabar symbols containing any number of characters within the scanner capability.



Codabar - Any Length

CLSI Editing

When enabled, this parameter strips the start and stop characters and inserts a space after the first, fifth, and tenth characters of a 14-character Codabar symbol. Enable this feature if the host system requires this data format.



Symbol length does not include start and stop characters.

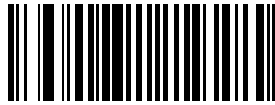

Enable CLSI Editing

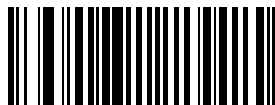

***Disable CLSI Editing**

NOTIS Editing

When enabled, this parameter strips the start and stop characters from a decoded Codabar symbol. Enable this feature if the host system requires this data format.



Enable NOTIS Editing



***Disable NOTIS Editing**

MSI

Enable/Disable MSI

To enable or disable MSI, scan the appropriate bar code below.



Enable MSI



***Disable MSI**

Set Lengths for MSI

The length of a code refers to the number of characters (i.e., human readable characters), including check digit(s) the code contains. Lengths for MSI may be set for any length, one or two discrete lengths, or lengths within a specific range.



When setting lengths for different bar code types by scanning single digit numbers, single digit numbers must always be preceded by a leading zero.

One Discrete Length - This option allows the scanner to decode only those MSI symbols containing a selected length. Lengths are selected from the numeric bar codes beginning on page [D-1](#) in [Appendix D, Numeric Bar Codes](#). For example, to decode only MSI symbols with 14 characters, scan **MSI - One Discrete Length**, then scan **1** followed by **4**. If an error is made or to change a selection, scan **Cancel** on page [D-8](#).



MSI - One Discrete Length

Two Discrete Lengths - This option allows the scanner to decode only those MSI symbols containing either of two selected lengths. Lengths are selected from the numeric bar codes beginning on page [D-1](#) in [Appendix D, Numeric Bar Codes](#). For example, to decode only those MSI symbols containing either 2 or 14 characters, select **MSI - Two Discrete Lengths**, then scan **0, 2, 1**, and then **4**. If an error is made or to change a selection, scan **Cancel** on page [D-8](#).



MSI - Two Discrete Lengths

Set Lengths for MSI (Continued)

Length Within Range - This option allows the scanner to decode an MSI symbol with a specific length range. The length range is selected from numeric bar codes beginning on page D-1 in [Appendix D, Numeric Bar Codes](#). For example, to decode MSI symbols containing between 4 and 12 characters, first scan **MSI - Length Within Range**. Then scan **0, 4, 1, and 2** (single digit numbers must always be preceded by a leading zero). If an error is made or to change a selection, scan **Cancel** on page D-8.



MSI - Length Within Range

Any Length - Scanning this option allows the scanner to decode MSI symbols containing any number of characters within the scanner capability.



Note

Due to the construction of the MSI symbology, it is possible for a scan line covering only a portion of the code to be interpreted as a complete scan, yielding less data than is actually encoded in the bar code. To prevent this from happening, it is recommended that specific lengths (**MSI - One Discrete Length - Two Discrete Lengths**) be selected for MSI applications.



MSI - Any Length

MSI Check Digits

With MSI symbols, one check digit is mandatory and always verified by the reader. The second check digit is optional. If the MSI codes include two check digits, enable the verification of the second check digit by scanning the barcode below.

Refer to [MSI Check Digit Algorithm on page 9-91](#) for the selection of second digit algorithms.



***One MSI Check Digit**



Two MSI Check Digits

Transmit MSI Check Digit(s)

Scan a bar code below to transmit MSI data with or without the check digit.



**Transmit MSI Check Digit(s)
(Enable)**



***Do Not Transmit MSI Check Digit(s)
(Disable)**

MSI Check Digit Algorithm

Two algorithms are possible for the verification of the second MSI check digit. Select the bar code below corresponding to the algorithm used to encode the check digit.



MOD 10/MOD 11



***MOD 10/MOD 10**

RSS (Reduced Space Symbology)

The variants of RSS are RSS 14, RSS Expanded, and RSS Limited. The limited and expanded versions have stacked variants. Scan the appropriate bar code below to enable or disable each variant of RSS.

RSS 14

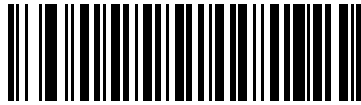

***Enable RSS 14**



Disable RSS 14

RSS Limited

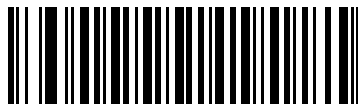

Enable RSS Limited



***Disable RSS Limited**

RSS Expanded



***Enable RSS Expanded**



Disable RSS Expanded

Convert RSS to UPC/EAN

The 14-digit Global Trade Item Number (GTIN) format will become a standard by January 2005 and will uniquely identify products worldwide. Although it is defined as a 14-digit structure, the barcode may contain 13 digits (EAN-13), 12 digits (UPC), or 8 digits (EAN-8) of data.

This parameter only applies to RSS-14 and RSS Limited symbols not decoded as part of a Composite symbol. When this conversion is enabled, RSS-14 and RSS Limited symbols beginning with 010 followed by 13 digits will be converted to EAN-13, and the leading 010 will be stripped.

0	1	0	X	X	X	X	X	X	X	X	X	X	X	X	X	X
---	---	---	---	---	---	---	---	---	---	---	---	---	---	---	---	---

X	X	X	X	X	X	X	X	X	X	X	X	X	X	X
---	---	---	---	---	---	---	---	---	---	---	---	---	---	---

E.g. 0101234567890128 will be converted to 1234567890128.

Symbols beginning with 0100 followed by 12 digits will be converted to UPC-A, and the leading 0100 will be stripped.

0	1	0	0	X	X	X	X	X	X	X	X	X	X	X	X
---	---	---	---	---	---	---	---	---	---	---	---	---	---	---	---

0	X	X	X	X	X	X	X	X	X	X	X	X	X
---	---	---	---	---	---	---	---	---	---	---	---	---	---

(if the UPC-A Preamble is "System Character and Country Code")

or

X	X	X	X	X	X	X	X	X	X	X	X	X
---	---	---	---	---	---	---	---	---	---	---	---	---

(if the UPC-A Preamble is "System Character")

or

X	X	X	X	X	X	X	X	X	X	X	X
---	---	---	---	---	---	---	---	---	---	---	---

(if the UPC-A Preamble is "No Preamble")

E.g. 0100123456789012 will be converted to 0123456789012 if the UPC-A Preamble is "System Character and Country Code," 123456789012 if the UPC-A Preamble is "System Character," and 23456789012 if the Preamble is "No Preamble."

Symbols beginning with 01 and followed by six zeroes and then 8 digits will not be converted.

Convert RSS to UPC/EAN (Continued)

0	1	0	0	0	0	0	0	X	X	X	X	X	X	X	X
---	---	---	---	---	---	---	---	---	---	---	---	---	---	---	---

E.g. 0100000012345670 will remain 0100000012345670.



Enable Convert RSS to UPC/EAN



***Disable Convert RSS to UPC/EAN**

Symbology - Specific Security Levels

Redundancy Level

The Symbol LS9203 offer four levels of decode redundancy. Higher redundancy levels are selected for decreasing levels of bar code quality. As redundancy levels increase, the scanner's aggressiveness decreases.

Select the redundancy level appropriate for the bar code quality.

Redundancy Level 1

The following code types must be successfully read twice before being decoded:

Table 9-2. Redundancy Level 1 Code Types

Code Type	Length
Codabar	8 characters or less
MSI	4 characters or less
D 2 of 5	8 characters or less
I 2 of 5	8 characters or less

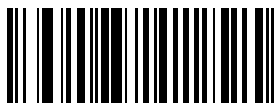

*Redundancy Level 1

Redundancy Level 2

The following code types must be successfully read twice before being decoded:

Table 9-3. Redundancy Level 2 Code Types

Code Type	Length
All	All

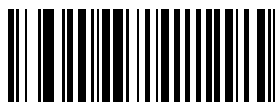

Redundancy Level 2

Redundancy Level 3

Level 3 ensures that the enabled linear bar code types are read twice before reporting a good decode. The following codes must be read three times:

Table 9-4. Redundancy Level 3 Code Types

Code Type	Length
MSI	4 characters or less
D 2 of 5	8 characters or less
I 2 of 5	8 characters or less
Codabar	8 characters or less



Redundancy Level 3

Redundancy Level 4

The following code types must be successfully read three times before being decoded:

Table 9-5. Redundancy Level 4 Code Types

Code Type	Length
All	All

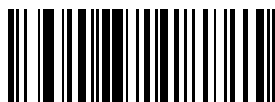

Redundancy Level 4

Security Level

The Symbol LS9203 offer four levels of decode security for the delta bar codes. These include the Code 128 family, UPC/EAN, Code 93 and Scanlet. Increasing levels of security are provided for decreasing levels of bar code quality. There is an inverse relationship between security and scanner aggressiveness, so be sure to choose only that level of security necessary for any given application.

Security Level 0

This is the default setting which allows the scanner to operate fastest, while providing sufficient security in decoding most “in-spec” bar codes.

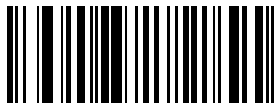

*** Security Level 0**

Security Level 1

Choose this option if misdecodes occur. This level should eliminate most misdecodes.



Security Level 1

Security Level 2

Choose this option if Security Level 1 fails to eliminate misdecodes.

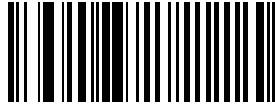

Security Level 2

Security Level 3

If Security Level 2 has been tried, and are still experiencing misdecodes, select this security level. Be advised, selecting this option is an extreme measure against misdecoding severely out of spec bar codes. Selection of this level of security may significantly impair the decoding ability of the scanner. If this level of security is necessary, try to improve the quality of the bar codes.

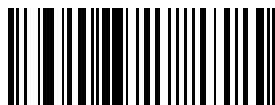

Security Level 3

Symbology - Intercharacter Gap

The Code 39 and Codabar symbologies have an intercharacter gap that is customarily quite small. Due to various bar code-printing technologies, this gap may grow larger than the maximum size allowed, causing the scanner to be unable to decode the symbol. If this problem is encountered, then the "Large Intercharacter Gaps" parameter should be scanned, to tolerate these out-of-specification barcodes.



***Normal Intercharacter Gaps**



Large Intercharacter Gaps

10

Miscellaneous Scanner Options

Chapter Contents

Introduction	10-3
Scanning Sequence Examples	10-3
Errors While Scanning	10-3
Miscellaneous Default Parameters	10-3
Miscellaneous Scanner Parameters	10-4
Transmit Code ID Character	10-4
Prefix/Suffix Values	10-6
FN1 Substitution Values	10-9
Scan Data Transmission Format	10-10
Transmit "No Read" Message	10-14
Report Version	10-15

Introduction

This chapter includes commonly used bar codes to customize how your data is transmitted to your host device. In addition to these bar codes for data formatting, refer to each host chapter for the appropriate host connections and host device features for your scanner. Refer to [Chapter 9, Symbologies](#) and the *Advanced Data Formatting Programmer Guide* for customizing data for transmission to your host device.

Before programming, follow the instructions in [Chapter 1, Getting Started](#).

Your scanner is shipped with the settings shown in the [Miscellaneous Scanner Options Default Table on page 10-3](#) (also see [Chapter A, Standard Default Parameters](#) for all host device and miscellaneous scanner defaults). If the default values suit your requirements, programming may not be necessary. Features values are set by scanning single bar codes or short bar code sequences.

Scanning Sequence Examples

In most cases you need only scan one bar code to set a specific parameter value.

Parameters, such as **Prefix Value**, require that you scan several bar codes in the proper sequence. Refer to each individual parameter for descriptions of this procedure.

Errors While Scanning

Unless otherwise specified, if you make an error during a scanning sequence, just re-scan the correct parameter.

Miscellaneous Default Parameters

[Table 10-1](#) lists the defaults for miscellaneous scanner options parameters. If you wish to change any option, scan the appropriate bar code(s) provided in the Miscellaneous Scanner Parameters section beginning on page [10-4](#).



See [Chapter A, Standard Default Parameters](#) for all user preferences, hosts, symbologies, and miscellaneous default parameters.

Table 10-1. Miscellaneous Scanner Options Default Table

Parameter	Default	Page Number
Transmit Code ID Character	Disable	10-4
Suffix Value (Value 1)	<CR><LF>	10-6
Prefix Value (Value 2)	None	10-6
FN1 Substitution Values	7013	10-9
Scan Data Transmission Format	Data as is	10-10
Transmit "No Read" Message	Disable	10-14
Report Version		10-15

Miscellaneous Scanner Parameters

Transmit Code ID Character

A Code ID character identifies the code type of a scanned bar code. This may be useful when the scanner is decoding more than one code type. In addition to any single character prefix already selected, the Code ID character is inserted between the prefix and the decoded symbol.

The user may select no Code ID character, a Symbol Code ID character, or an AIM Code ID character. For Code ID Characters, see [Symbol Code Identifiers on page B-3](#) and [AIM Code Identifiers on page B-4](#).

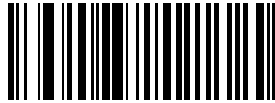

Symbol Code ID Character



AIM Code ID Character

Transmit Code ID Character (Continued)

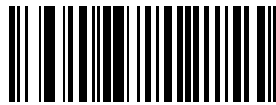

***None**

Prefix/Suffix Values

A prefix/suffix may be appended to scan data for use in data editing. These values are set by scanning a four-digit number (i.e., four bar codes) that corresponds to key codes for various terminals. Code 39 Full ASCII to Full ASCII Correlation is host-dependent, and therefore described in the "ASCII Character Set" Table for the appropriate interface. Numeric bar codes begin on page [D-1](#) in [D](#). If an error is made or to change a selection, scan **Cancel** on page [D-8](#).

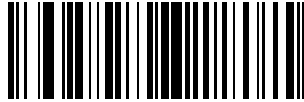

Scan Suffix (Value 1)

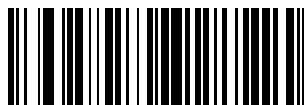

Scan Prefix (Value 2)

Prefix/Suffix Values (Continued)



Set Value 3



Set Value 4

Prefix/Suffix Values (Continued)



Set Value 5



Set FN1 Substitution Value (Value 6)

FN1 Substitution Values

The Wedge and USB HID Keyboard hosts support a FN1 Substitution feature. In this feature, if enabled, any FN1 character (0x1b) in an EAN128 barcode is substituted for this value. This value defaults to 7013 (Enter Key)

1. Scan the bar code below.

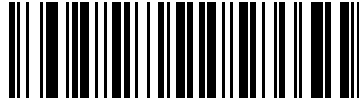

FN1 Substitution Value (Value 6)

2. Look up the keystroke for FN1 Substitution in the *ASCII Character Set* table for the currently installed host interface. Enter the 4-digit "ASCII Value" by scanning each digit in the [Numeric Bar Codes on page D-1](#).

Scan Data Transmission Format

To change the Scan Data Transmission Format, scan the **Scan Options** bar code below. Then select one of four options:

- Data As Is
- <DATA> <SUFFIX>
- <PREFIX> <DATA>
- <PREFIX> <DATA> <SUFFIX>

When you have made your selection, scan the **Enter** bar code on page [10-12](#). If you make a mistake, scan the **Data Format Cancel** bar code on page [10-13](#).

If you need to have a carriage return/enter after each bar code scanned, scan the following bar codes in order:

1. <SCAN OPTIONS>
2. <DATA> <SUFFIX>
3. Enter (on page [10-12](#))

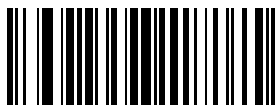

Scan Options



***Data As Is**

Scan Data Transmission Format (Continued)

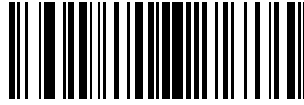

<DATA> <SUFFIX>

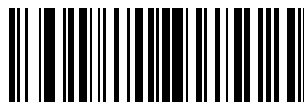

<PREFIX> <DATA>

Scan Data Transmission Format (Continued)



<PREFIX> <DATA> <SUFFIX>



Enter

Scan Data Transmission Format (Continued)



Data Format Cancel

Transmit "No Read" Message

Scan a bar code below to select whether or not a "No Read" message is transmitted. When enabled, the characters NR are transmitted when a bar code is not decoded. Any prefixes or suffixes which are enabled are appended around this message. When disabled, if a symbol does not decode, nothing is sent to the host.



Enable No Read



***Disable No Read**

Report Version

Scan the bar code below to report the software revision installed in the scanner's primary microprocessor.

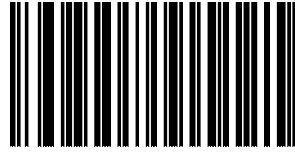

Report Software Version



Standard Default Parameters

Table A-1. Standard Default Parameters Table

Parameter	Default	Page Number
User Preferences		
Set Default Parameter	All Defaults	4-5
Beeper Tone	High	4-6
Beeper Volume	High	4-8
Laser On Time	3.0 sec	4-10
Beep After Good Decode	Enable	4-11
Time-out Between Same Symbol	0.6 sec	4-12
Time-out Between Different Symbols	0.2 sec	4-12
Time Delay to Low Power Mode	30 Minutes	4-13
Keyboard Wedge Host Parameters		
Keyboard Wedge Host Type	IBM PC/AT& IBM PC Compatibles ¹	5-5
Country Types (Country Codes)	North American	5-8
¹ User selection is required to configure this interface and this is the most common selection.		

Table A-1. Standard Default Parameters Table (Continued)

Parameter	Default	Page Number
Ignore Unknown Characters	Transmit	5-14
Keystroke Delay	No Delay	5-15
Inter-Keystroke Delay	Disable	5-17
Alternate Numeric Keypad Emulation	Disable	5-18
Caps Lock On	Disable	5-19
Caps Lock Override	Disable	5-20
Convert Wedge Data	No Convert	5-21
Function Key Mapping	Disable	5-23
FN1 Substitution	Disable	5-24
Send Make Break	Disable	5-25
¹ User selection is required to configure this interface and this is the most common selection.		

Table A-1. Standard Default Parameters Table (Continued)

Parameter	Default	Page Number
RS-232 Host Parameters		
RS-232 Host Types	Standard ¹	6-7
Baud Rate	9600	6-11
Parity	None	6-15
Check Receive Errors	Enable	6-18
Hardware Handshaking	None	6-19
Software Handshaking	None	6-22
Host Serial Response Time-out	2 Sec	6-25
RTS Line State	Low RTS	6-28
Stop Bit Select	1	6-29
Data Bits	8-Bit	6-30
Beep on <BEL>	Disable	6-31
Intercharacter Delay	0 msec	6-32
Nixdorf Beep/LED Options	Normal Operation	6-35
Ignore Unknown Characters	Send Bar Codes	6-37
USB Host Parameters		
USB Device Type	HID (Human Interface Device) Keyboard Emulation	7-5
USB Country Keyboard Types (Country Codes)	North American	7-8
USB Keystroke Delay	No Delay	7-14
USB CAPS Lock Override	Disable	7-16
USB Ignore Enable Transmission	Enable	7-16
Emulate Keypad	Disable	7-18
USB Keyboard FN1 Substitution	Disable	7-19
Function Key Mapping	Disable	7-20
Simulated Caps Lock	Disable	7-21
Convert Case	Disable	7-22
¹ User selection is required to configure this interface and this is the most common selection.		

Table A-1. Standard Default Parameters Table (Continued)

Parameter	Default	Page Number
Wand Emulation Host Parameters		
Wand Emulation Host Types	Symbol OmniLink Interface Controller ¹	8-5
Leading Margin	80 msec	8-7
Polarity	Bar High/Margin Low	8-9
Ignore Unknown Characters	Transmit	8-10
Convert All Bar Codes to Code 39	Disable	8-11
Convert Code 39 to Full ASCII	Disable	8-12
UPC/EAN		
UPC-A	Enable	9-9
UPC-E	Enable	9-10
UPC-E1	Disable	9-11
EAN-8/JAN-8	Enable	9-12
EAN-13/JAN-13	Enable	9-12
Bookland EAN	Disable	9-14
Decode UPC/EAN Supplementals (2 and 5 digits)	Ignore	9-15
Decode UPC/EAN Supplemental Redundancy	20	9-24
Transmit UPC-A Check Digit	Transmit	9-25
Transmit UPC-E Check Digit	Transmit	9-25
Transmit UPC-E1 Check Digit	Transmit	9-25
UPC-A Preamble	System Character	9-28
UPC-E Preamble	System Character	9-30
UPC-E1 Preamble	System Character	9-32
Convert UPC-E to A	Disable	9-34
Convert UPC-E1 to A	Disable	9-35
EAN-8 Zero Extend	Disable	9-36
Bookland ISBN Format	ISBN-10	9-37
UCC Coupon Extended Code	Disable	9-38
Linear UPC/EAN Decode	Disable	9-39
¹ User selection is required to configure this interface and this is the most common selection.		

Table A-1. Standard Default Parameters Table (Continued)

Parameter	Default	Page Number
Code 128		
Code 128	Enable	9-40
UCC/EAN-128	Enable	9-41
ISBT 128 (non-concatenated)	Enable	9-42
Code 128 Decode Performance	Enable	9-43
Code 128 Decode Performance Level	Level 3	9-44
Code 39		
Code 39	Enable	9-46
Trioptic Code 39	Disable	9-47
Convert Code 39 to Code 32 (Italian Farmer Code)	Disable	9-48
Code 32 Prefix	Disable	9-49
Set Length(s) for Code 39	2 to 55	9-50
Code 39 Check Digit Verification	Disable	9-52
Transmit Code 39 Check Digit	Do Not Transmit	9-53
Code 39 Full ASCII Conversion	Disable	9-54
Buffer Code 39	Disable	9-55
Code 39 Decode Performance	Enable	9-58
Code 39 Decode Performance Level	Level 3	9-59
Code 93		
Code 93	Disable	9-61
Set Length(s) for Code 93	4 to 55	9-62
Code 11		
Code 11	Disable	9-64
Set Lengths for Code 11	4 to 55	9-65
Code 11 Check Digit Verification	Disable	9-67
Transmit Code 11 Check Digit	Do Not Transmit	9-69
¹ User selection is required to configure this interface and this is the most common selection.		

Table A-1. Standard Default Parameters Table (Continued)

Parameter	Default	Page Number
Interleaved 2 of 5 (ITF)		
Interleaved 2 of 5 (ITF)	Disable	9-70
Set Length(s) for I 2 of 5	14	9-71
I 2 of 5 Check Digit Verification	Disable	9-73
Transmit I 2 of 5 Check Digit	Do Not Transmit	9-75
Convert I 2 of 5 to EAN 13	Disable	9-76
Discrete 2 of 5 (DTF)		
Discrete 2 of 5	Disable	9-77
Set Length(s) for D 2 of 5	12	9-78
Chinese 2 of 5		
Enable/Disable Chinese 2 of 5	Disable	9-80
Codabar (NW - 7)		
Codabar	Disable	9-81
Set Lengths for Codabar	5 to 55	9-82
CLSI Editing	Disable	9-84
NOTIS Editing	Disable	9-85
MSI		
MSI	Disable	9-86
Set Length(s) for MSI	1 to 55	9-87
MSI Check Digits	One	9-89
Transmit MSI Check Digit	Disable	9-90
MSI Check Digit Algorithm	Mod 10/Mod 10	9-91
RSS (Reduced Space Symbology)		
RSS 14	Enable	9-92
RSS Limited	Disable	9-93
RSS Expanded	Enable	9-94
Convert RSS to UPC/EAN	Disable	9-95
¹ User selection is required to configure this interface and this is the most common selection.		

Table A-1. Standard Default Parameters Table (Continued)

Parameter	Default	Page Number
Symbology - Specific Security Levels		
Redundancy Security Levels	1	9-97
Security Level	0	9-99
Symbology - Intercharacter Gap		
Intercharacter Gaps	Normal	9-101
Miscellaneous Scanner Options		
Transmit Code ID Character	Disable	10-4
Suffix Value (Value 1)	<CR><LF>	10-6
Prefix Value (Value 2)	None	10-6
FN1 Substitution Values	7013	10-9
Scan Data Transmission Format	Data as is	10-10
Transmit "No Read" Message	Disable	10-14
Report Version		10-15
¹ User selection is required to configure this interface and this is the most common selection.		

B

Programming Reference

Symbol Code Identifiers

Table B-1. Code Characters

Code Character	Code Type
A	UPC/EAN
B	Code 39, Code 39 Full ASCII, Code 32
C	Codabar
D	Code 128, ISBT 128
E	Code 93
F	Interleaved 2 of 5
G	Discrete 2 of 5, IATA
H	Code 11
J	MSI Plessey
K	UCC/EAN-128
L	Bookland EAN
M	Code 39 Trioptic
N	Coupon Code
R	RSS
X	Unknown
U	Chinese 2 of 5

AIM Code Identifiers

Each AIM Code Identifier contains the three-character string **Jcm** where:

J=Flag Character (ASCII 93)

c=Code Character

m=Modifier Character

Table B-2. AIM Code Characters

Code Character	Code Type
A	Code 39, Code 39 Full ASCII, Code 32
C	Code 128 (all variants), Coupon (Code 128 portion)
E	UPC/EAN, Coupon (UPC/EAN portion)
F	Codabar
G	Code 93
H	Code 11
I	Interleaved 2 of 5
M	MSI Plessey
S	Discrete 2 of 5, IATA
X	Bookland EAN, Code 39 Trioptic, Chinese 2 of 5
e	RSS

The modifier character is the sum of the applicable option values based on [Table B-3](#).

Table B-3. Modifier Characters

Code Type	Option Value	Option
Code 39		
	0	No Check character.
	1	Reader has checked one check character.
	3	Reader has checked and stripped check character.
	4	Reader has performed Full ASCII character conversion.
	5	Reader has performed Full ASCII character conversion and checked one check character.
	7	Reader has performed Full ASCII character conversion and checked and stripped check character.
	Example: A Full ASCII bar code with check character W, A+I+MI+DW , is transmitted as JA7 AimId where 7 = (3+4).	
Trioptic Code 39		
	0	No option specified at this time. Always transmit 0.
	Example: A Trioptic bar code 412356 is transmitted as JX0 412356	
Code 128		
	0	Standard data packet, No Function code 1 in first symbol position.
	1	Function code 1 in first symbol character position.
	2	Function code 1 in second symbol character position.
	Example: A Code (EAN) 128 bar code with Function 1 character in the first position, FNC1 Aim Id is transmitted as JC1 AimId	
I 2 of 5		
	0	No check digit processing.
	1	Reader has validated check digit.
	3	Reader has validated and stripped check digit.
	Example: An I 2 of 5 bar code without check digit, 4123, is transmitted as JIO 4123	
Codabar		
	0	Standard Codabar
	1	ABC Codabar
	Example: A standard Codabar bar code, 4123, is transmitted as JF0 4123	
Code 93		
	0	No options specified at this time. Always transmit 0.
	Example: A Code 93 bar code 012345678905 is transmitted as JG00 12345678905	
MSI Plessey		
	0	Mod 10 check digit validated and transmitted.
	1	Mod 10 check digit validated but not transmitted.
	Example: An MSI Plessey bar code 4123, with Mod 10 check digit validated, is transmitted as JM0 4123	
D 2 of 5		
	0	No options specified at this time. Always transmit 0.
	Example: A D 2 of 5 bar code 4123, is transmitted as JS0 4123	

Table B-3. Modifier Characters (Continued)

Code Type	Option Value	Option
Chinese 2 of 5		
	0	No options specified at this time. Always transmit 0. Example: A Chinese 2 of 5 bar code 4123, is transmitted as JX0 4123
UPC/EAN		
	0	Standard packet in full EAN country code format, which is 13 digits for UPC-A, UPC-E, and EAN-13 (not including supplemental data).
	1	Two digit supplement data only.
	2	Five digit supplement data only.
	3	Combined data packet comprising 13 digits from a UPC-A, UPC-E, or EAN-13 symbol and 2 or 5 digits from a supplemental symbol.
	4	EAN-8 data packet. Example: A UPCA bar code 012345678905 is transmitted as JE000 12345678905
Bookland EAN		
	0	No options specified at this time. Always transmit 0. Example: A Bookland EAN bar code 123456789X is transmitted as JX0 123456789X
RSS Family		
		No option specified at this time. Always transmit 0. RSS-14 and RSS-Limited transmit with an Application Identifier "01". Note: In UCC/EAN-128 emulation mode, RSS is transmitted using Code 128 rules (i.e., J1C1).
		Example: An RSS-14 bar code 100123456788902 is transmitted as Je001 100123456788902.

C

Sample Bar Codes

Code 39



UPC/EAN

UPC-A, 100%



EAN-13, 100%



Code 128



Interleaved 2 of 5



RSS 14

RSS 14 must be enabled to read the bar code below (see [RSS 14](#) on page 9-92).



D

Numeric Bar Codes



0, 1

For parameters requiring specific numeric values, scan the appropriately numbered bar code(s).

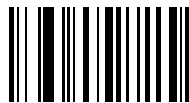

0

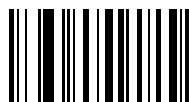

1

2, 3



2



3

4, 5

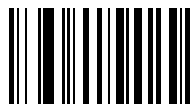

4



5

6, 7



6



7

8, 9

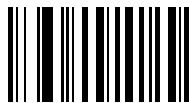

8



9

Cancel

If an error is made or to change a selection, scan the bar code below.



Cancel

Glossary

Aperture	The opening in an optical system defined by a lens or baffle that establishes the field of view.
AIM	The Automatic Identification Manufacturers Inc., a trade association.
ASCII	American Standard Code for Information Interchange. A 7 bit-plus-parity code representing 128 letters, numerals, punctuation marks, and control characters. It is a standard data transmission code in the U.S.
Autodiscrimination	The ability of an interface controller to determine the code type of a scanned bar code. After this determination is made, the information content is decoded.
Bar	The dark element in a printed bar code symbol.
Bar Code Density	The number of characters represented per unit of measurement (e.g., characters per inch).
Bar Height	The dimension of a bar measured perpendicular to the bar width.
Bar Width	Thickness of a bar measured from the edge closest to the symbol start character to the trailing edge of the same bar.
Baud Rate	A measure of the data flow or number of signaling events occurring per second. When one bit is the standard "event," this is a measure of bits per second (bps). For example, a baud rate of 50 means transmission of 50 bits of data per second.
Bit	Binary digit. One bit is the basic unit of binary information. Generally, eight consecutive bits compose one byte of data. The pattern of 0 and 1 values within the byte determines its meaning.

Byte	On an addressable boundary, eight adjacent binary digits (0 and 1) combined in a pattern to represent a specific character or numeric value. Bits are numbered from the right, 0 through 7, with bit 0 the low-order bit. One byte in memory is used to store one ASCII character.
CDRH	Center for Devices and Radiological Health. A federal agency responsible for regulating laser product safety. This agency specifies various laser operation classes based on power output during operation.
CDRH Class 1	This is the lowest power CDRH laser classification. There are no special operating procedures for this class.
CDRH Class 2	No additional software mechanisms are needed to conform to this limit. Laser operation in this class poses no danger for unintentional direct human exposure.
Character	A pattern of bars and spaces which either directly represents data or indicates a control function, such as a number, letter, punctuation mark, or communications control contained in a message.
Character Set	Those characters available for encoding in a particular bar code symbology.
Check Digit	A digit used to verify a correct symbol decode. The scanner inserts the decoded data into an arithmetic formula and checks that the resulting number matches the encoded check digit. Check digits are required for UPC but are optional for other symbologies. Using check digits decreases the chance of substitution errors when a symbol is decoded.
Codabar	A discrete self-checking code with a character set consisting of digits 0 to 9 and six additional characters: (- \$: / , +).
Code 128	A high density symbology which allows the controller to encode all 128 ASCII characters without adding extra symbol elements.
Code 3 of 9 (Code 39)	A versatile and widely used alphanumeric bar code symbology with a set of 43 character types, including all uppercase letters, numerals from 0 to 9, and 7 special characters (- . / + % \$ and space). The code name is derived from the fact that 3 of 9 elements representing a character are wide, while the remaining 6 are narrow.
Code 93	An industrial symbology compatible with Code 39 but offering a full character ASCII set and a higher coding density than Code 39.
Code Length	Number of data characters in a bar code between the start and stop characters, not including those characters.
Continuous Code	A bar code or symbol in which all spaces within the symbol are parts of characters. There are no intercharacter gaps in a continuous code. The absence of gaps allows for greater information density.
Dead Zone	An area within a scanner's field of view, in which specular reflection may prevent a successful decode.
Decode	To recognize a bar code symbology (e.g., UPC/EAN) and then analyze the content of the specific bar code scanned.
Decode Algorithm	A decoding scheme that converts pulse widths into data representation of the letters or numbers encoded within a bar code symbol.
Depth of Field	The range between minimum and maximum distances at which a scanner can read a symbol with a certain minimum element width.
Discrete Code	A bar code or symbol in which the spaces between characters (intercharacter gaps) are not part of the code.

Discrete 2 of 5	A binary bar code symbology representing each character by a group of five bars, two of which are wide. The location of wide bars in the group determines which character is encoded; spaces are insignificant. Only numeric characters (0 to 9) and START/STOP characters may be encoded.
EAN	European Article Number. This European/International version of the UPC provides its own coding format and symbology standards. Element dimensions are specified metrically. EAN is used primarily in retail.
Element	Generic term for a bar or space.
Encoded Area	Total linear dimension occupied by all characters of a code pattern, including start/stop characters and data.
Host Computer	A computer that serves other terminals in a network, providing such services as computation, database access, supervisory programs, and network control.
IEC	International Electrotechnical Commission. This international agency regulates laser safety by specifying various laser operation classes based on power output during operation.
IEC Class 1	This is the lowest power IEC laser classification. There is no special operating procedures for this class.
Intercharacter Gap	The space between two adjacent bar code characters in a discrete code.
Interleaved Bar Code	A bar code in which characters are paired together, using bars to represent the first character and the intervening spaces to represent the second.
Interleaved 2 of 5	A binary bar code symbology representing character pairs in groups of five bars and five interleaved spaces. Interleaving provides for greater information density. The location of wide elements (bar/spaces) within each group determines which characters are encoded. This continuous code type uses no intercharacter spaces. Only numeric (0 to 9) and START/STOP characters may be encoded.
LASER - Light Amplification by Stimulated Emission of Radiation	The laser is an intense light source. Light from a laser is all the same frequency, unlike the output of an incandescent bulb. Laser light is typically coherent and has a high energy density.
Laser Diode	A gallium-arsenide semiconductor type of laser connected to a power source to generate a laser beam. This laser type is a compact source of coherent light.
LED Indicator	A semiconductor diode (LED - Light Emitting Diode) used as an indicator, often in digital displays. The semiconductor uses applied voltage to produce light of a certain frequency determined by the semiconductor's particular chemical composition.
MIL	1 mil = 1 thousandth of an inch.
Misread (Misdecode)	A condition which occurs when the data output of a reader or interface controller does not agree with the data encoded within a bar code symbol.
Nominal	The exact (or ideal) intended value for a specified parameter. Tolerances are specified as positive and negative deviations from this value.
Nominal Size	Standard size for a bar code symbol. Most UPC/EAN codes are used over a range of magnifications (e.g., from 0.80 to 2.00 of nominal).
Parameter	A variable that can have different values assigned to it.
Percent Decode	The average probability that a single scan of a bar code would result in a successful decode. In a well-designed bar code scanning system, that probability should approach near 100%.

Print Contrast Signal (PCS)	Measurement of the contrast (brightness difference) between the bars and spaces of a symbol. A minimum PCS value is needed for a bar code symbol to be scannable. $PCS = (RL - RD) / RL$, where RL is the reflectance factor of the background and RD the reflectance factor of the dark bars.
Programming Mode	The state in which a scanner is configured for parameter values. See SCANNING MODE.
Quiet Zone	A clear space, containing no dark marks, which precedes the start character of a bar code symbol and follows the stop character.
Reflectance	Amount of light returned from an illuminated surface.
Resolution	The narrowest element dimension which is distinguished by a particular reading device or printed with a particular device or method.
RSS	Reduced Space Symbology: A family of space efficient symbologies developed by UCC.EAN.
Scan Area	Area intended to contain a symbol.
Scanner	An electronic device used to scan bar code symbols and produce a digitized pattern that corresponds to the bars and spaces of the symbol. Its three main components are: <ol style="list-style-type: none"> 1. Light source (laser or photoelectric cell) - illuminates a bar code. 2. Photodetector - registers the difference in reflected light (more light reflected from spaces). 3. Signal conditioning circuit - transforms optical detector output into a digitized bar pattern.
Scanning Mode	The scanner is energized, programmed, and ready to read a bar code.
Scanning Sequence	A method of programming or configuring parameters for a bar code reading system by scanning bar code menus.
Self-Checking Code	A symbology that uses a checking algorithm to detect encoding errors within the characters of a bar code symbol.
Space	The lighter element of a bar code formed by the background between bars.
Specular Reflection	The mirror-like direct reflection of light from a surface, which can cause difficulty decoding a bar code.
Start/Stop Character	A pattern of bars and spaces that provides the scanner with start and stop reading instructions and scanning direction. The start and stop characters are normally to the left and right margins of a horizontal code.
Substrate	A foundation material on which a substance or image is placed.
Symbol	A scannable unit that encodes data within the conventions of a certain symbology, usually including start/stop characters, quiet zones, data characters, and check characters.
Symbol Aspect Ratio	The ratio of symbol height to symbol width.
Symbol Height	The distance between the outside edges of the quiet zones of the first row and the last row.
Symbol Length	Length of symbol measured from the beginning of the quiet zone (margin) adjacent to the start character to the end of the quiet zone (margin) adjacent to a stop character.

Symbology	The structural rules and conventions for representing data within a particular bar code type (e.g. UPC/EAN, Code 39).
Tolerance	Allowable deviation from the nominal bar or space width.
UPC	Universal Product Code. A relatively complex numeric symbology. Each character consists of two bars and two spaces, each of which is any of four widths. The standard symbology for retail food packages in the United States.
Visible Laser Diode (VLD)	A solid state device which produces visible laser light.

Index

A

AIM code identifiersB-4
aiming 2-7, 2-8
ASCII values 6-38

B

bar codes
 beep after good decode 4-11
 beeper tone 4-6
 beeper volume 4-8
 code 11
 lengths 9-66
 code 39
 transmit buffer 9-56
 data options 10-4, 10-5
 prefix/suffix values 10-6
 transmit code ID character 10-4, 10-5
 discrete 2 of 5
 lengths 9-79
 interleaved 2 of 5 9-70
 convert to EAN-13 9-76
 lengths 9-71, 9-72
 keyboard wedge
 alternate numeric keypad emulation ... 5-18
 caps lock on 5-19
 caps lock override 5-20
 country keyboard types (country codes) .5-8
 default table 5-4
 host types 5-5, 5-6, 5-7
 ignore unknown characters 5-14

 intra-keystroke delay 5-17
 keystroke delay 5-15, 5-16
 laser on time 4-10
 linear code type security level 9-97
 miscellaneous
 transmit no read msg 10-14
 numeric bar codes D-8
 report version 10-15
RS-232
 ASCII format 6-30
 baud rate 6-11
 beep on bel 6-31
 check receive errors 6-18
 default table 6-3
 hardware handshaking 6-19
 host serial response time-out 6-25, 6-26, 6-27
 host types 6-7, 6-8, 6-9, 6-10
 intercharacter delay 6-32, 6-33, 6-34
 parity 6-15, 6-16, 6-17
 RTS line state 6-28
 software handshaking 6-22
 stop bit select 6-29
set defaults 4-5
symbolologies
 bookland EAN 9-14
 bookland ISBN 9-37
 buffering 9-55
 codabar 9-81
 codabar CLSI editing 9-84
 codabar lengths 9-82
 codabar NOTIS editing 9-85

code 11	9-64
code 11 lengths	9-65
code 128	9-40
code 39	9-46
code 39 check digit verification	9-52
code 39 full ASCII	9-54
code 39 lengths	9-50, 9-51
code 39 transmit check digit	9-53
code 93	9-61
code 93 lengths	9-62
convert UPC-E to UPC-A	9-34
convert UPC-E1 to UPC-A	9-35
default table	9-6
discrete 2 of 5	9-77
discrete 2 of 5 lengths	9-78
EAN zero extend	9-36
EAN-13/EAN-8	9-12, 9-13
I 2 of 5 check digit verification	9-73, 9-74
I 2 of 5 convert to EAN-13	9-76
I 2 of 5 transmit check digit	9-75
ISBT 128	9-42
MSI	9-86
MSI check digit algorithm	9-91
MSI check digits	9-89
MSI lengths	9-87
MSI transmit check digit	9-90
supplementals	9-15
UCC coupon extended code	9-38
UCC/EAN-128	9-41
UPC-A preamble	9-28, 9-29
UPC-A/E/E1 check digit	9-25
UPC-A/UPC-E	9-9, 9-10
UPC-E preamble	9-30, 9-31
UPC-E1	9-11
UPC/EAN supplemental redundancy	9-24
UPC/EAN	
coupon code	9-38
USB	
caps lock override	7-16
country keyboard types	7-8
default table	7-4
device type	7-5, 7-6, 7-7
keystroke delay	7-14, 7-15
unknown characters	7-17
wand emulation	
code 39 full ASCII	8-12
convert all bar codes to code 39	8-11
default table	8-4
host types	8-5, 8-6
leading margin (quiet zone)	8-7, 8-8
polarity	8-9
unknown characters	8-10

C

cables	
installing	1-4
interface	1-4
removing cables	1-5

character set	6-38
codabar bar codes	
CLSI editing	9-84
codabar	9-81
lengths	9-82
NOTIS editing	9-85
code 11 bar codes	
code 11	9-64
lengths	9-65
code 128 bar codes	
code 128	9-40
ISBT 128	9-42
UCC/EAN-128	9-41
code 39 bar codes	
buffering	9-55
check digit verification	9-52
code 39	9-46
full ASCII	9-54
lengths	9-50, 9-51
transmit check digit	9-53
code 93 bar codes	
code 93	9-61
lengths	9-62
code ID characters	
AIM	B-4
code identifiers	
Symbol code IDs	B-3
connecting power	1-4
customer interaction center	xiv

D

default parameters	4-4
keyboard wedge	5-4
miscellaneous scanner options	10-3
RS-232	6-3
standard default table	A-3
symbolologies	9-6
USB	7-4
user preferences	4-4
wand emulation	8-4
discrete 2 of 5 bar codes	
discrete 2 of 5	9-77
lengths	9-78

H

host types	
keyboard wedge	5-5, 5-6, 5-7
RS-232	6-7, 6-8, 6-9, 6-10
wand emulation	8-5, 8-6

I

interleaved 2 of 5 bar codes	
check digit verification	9-73, 9-74
convert to EAN-13	9-76
transmit check digit	9-75

K

- keyboard wedge connection 5-3
- keyboard wedge default parameters 5-4
- keyboard wedge parameters 5-5

M

- maintenance 3-3
- miscellaneous scanner parameters 10-3
- mounting template 2-9
- MSI bar codes
 - check digit algorithm 9-91
 - check digits 9-89
 - lengths 9-87
 - MSI 9-86
 - transmit check digit 9-90

N

- notational conventions xiii

P

- parameters
 - keyboard wedge 5-5
 - RS-232 6-5
 - USB 7-5
 - wand emulation 8-5
- pinouts
 - scanner signal descriptions 3-6
- power supply
 - connecting 1-4
- prefix/suffix values 6-38
- programming bar codes
 - time delay to low power mode . . 4-13, 4-14, 4-15
 - timeout between decodes 4-12

Q

- quiet zone (leading margin) 8-7, 8-8

R

- report version 10-15
- RS-232 connection 6-3
- RS-232 default parameters 6-3
- RS-232 parameters 6-5, 6-7, 6-8, 6-9, 6-10

S

- scanner defaults 4-4
- scanning
 - aiming 2-7, 2-8
 - errors 4-3, 9-5, 10-3
 - hand-held 2-7
 - hands-free 2-3
 - sequence example 4-3, 9-5, 10-3
- service information xiv

setup

- connecting a USB interface 7-3
- connecting an RS-232 interface 6-3
- connecting interface cable 1-4
- connecting keyboard wedge interface 5-3
- connecting power 1-4
- connecting power supply 1-4
- connecting using wand emulation 8-3
- installing the cable 1-4
- unpacking 1-3
- signal descriptions 3-6
- specifications 3-4
- standard default parameters A-3
- standard defaults 4-4
- sybology default parameters 9-6

T

- technical specifications 3-4
- template, stand mounting 2-9

U

- unpacking 1-3
- UPC/EAN bar codes
 - bookland EAN 9-14
 - bookland ISBN 9-37
 - check digit 9-25
 - convert UPC-E to UPC-A 9-34
 - convert UPC-E1 to UPC-A 9-35
 - EAN zero extend 9-36
 - EAN-13/EAN-8 9-12, 9-13
 - supplemental redundancy 9-24
 - supplementals 9-15
 - UCC coupon extended code 9-38
 - UPC-A preamble 9-28, 9-29
 - UPC-A/UPC-E 9-9, 9-10
 - UPC-E preamble 9-30, 9-31
 - UPC-E1 9-11
- USB connection 7-3
- USB default parameters 7-4
- USB parameters 7-5
- user preferences parameters 4-4

W

- wand emulation connection 8-3
- wand emulation default parameters 8-4
- wand emulation parameters 8-5

Tell Us What You Think...

We'd like to know what you think about this Manual. Please take a moment to fill out this questionnaire and fax this form to: (631) 738-3318, or mail to:

Motorola
One Symbol Plaza M/S B-10
Holtsville, NY 11742-1300
Attention: Technical Publications Manager
Advanced Data Capture Division

IMPORTANT: If you need product support, please call the appropriate customer support number provided. Unfortunately, we cannot provide customer support at the fax number above.

Manual Title: _____
(please include revision level)

How familiar were you with this product before using this manual?

Very familiar Slightly familiar Not at all familiar

Did this manual meet your needs? If not, please explain.

What topics need to be added to the index, if applicable?

What topics do you feel need to be better discussed? Please be specific.

What can we do to further improve our manuals?

Thank you for your input—We value your comments.

Motorola
One Symbol Plaza
Holtsville, New York 11742-1300
<http://www.symbol.com>



72E-71538-03
Revision A - February 2007