

LS4278

Product Reference Guide

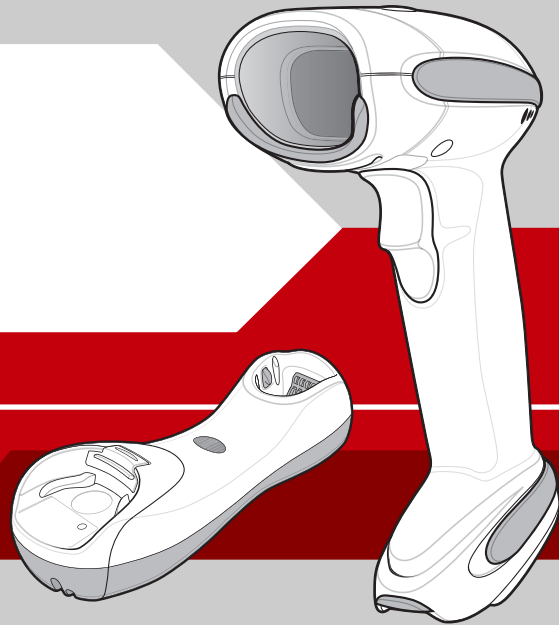

LS4278
Product Reference Guide

72E-69834-01
Revision A
November 2005

© 2005 by Symbol Technologies, Inc. All rights reserved.

No part of this publication may be reproduced or used in any form, or by any electrical or mechanical means, without permission in writing from Symbol. This includes electronic or mechanical means, such as photocopying, recording, or information storage and retrieval systems. The material in this manual is subject to change without notice.

The software is provided strictly on an "as is" basis. All software, including firmware, furnished to the user is on a licensed basis. Symbol grants to the user a non-transferable and non-exclusive license to use each software or firmware program delivered hereunder (licensed program). Except as noted below, such license may not be assigned, sublicensed, or otherwise transferred by the user without prior written consent of Symbol. No right to copy a licensed program in whole or in part is granted, except as permitted under copyright law. The user shall not modify, merge, or incorporate any form or portion of a licensed program with other program material, create a derivative work from a licensed program, or use a licensed program in a network without written permission from Symbol. The user agrees to maintain Symbol's copyright notice on the licensed programs delivered hereunder, and to include the same on any authorized copies it makes, in whole or in part. The user agrees not to decompile, disassemble, decode, or reverse engineer any licensed program delivered to the user or any portion thereof.

Symbol reserves the right to make changes to any software or product to improve reliability, function, or design.

Symbol does not assume any product liability arising out of, or in connection with, the application or use of any product, circuit, or application described herein.

No license is granted, either expressly or by implication, estoppel, or otherwise under any Symbol Technologies, Inc., intellectual property rights. An implied license only exists for equipment, circuits, and subsystems contained in Symbol products.

Symbol[®], Spectrum One[®], and Spectrum24[®] are registered trademarks of Symbol Technologies, Inc. Bluetooth[®] wireless technology is a registered trademark of Bluetooth SIG. Other product names mentioned in this manual may be trademarks or registered trademarks of their respective companies and are hereby acknowledged.

Symbol Technologies, Inc.
One Symbol Plaza
Holtsville, New York 11742-1300
<http://www.symbol.com>

Revision History

Changes to the original manual are listed below:

Change	Date	Description
	11/2005	Initial release.

Contents

Revision History	ix
------------------------	----

About This Guide

Introduction	xvii
Chapter Descriptions	xvii
Notational Conventions	xvii
Related Publications	xviii
Service Information	xviii
Symbol Support Center	xviii

Chapter 1. Getting Started

Introduction	1-3
Unpacking the Scanner and Cradle	1-4
Parts	1-5
Scanner Parts	1-5
Cradle Parts	1-6
Scanner Cradle	1-8
Connecting the Cradle	1-8
Supplying Power to the Cradle	1-9
Using the USB Interface to Supply Power	1-9
Connecting a Synapse Cable Interface	1-9
Lost Connection to Host	1-10
Mounting the Cradle	1-10
Replacing the Scanner Battery	1-11
Charging the Scanner Battery	1-12

Charging LED	1-12
Inserting the Scanner in the Cradle	1-12
Horizontal Cradle Mount	1-12
Vertical Cradle Mount	1-13
Radio Communications	1-13
Configuring the Scanner	1-13
Accessories	1-14
Lanyard	1-14

Chapter 2. Scanning

Introduction	2-3
Beeper Definitions	2-3
LED Definitions	2-4
Scanning in Hand-Held Mode	2-5
Aiming	2-6
Scanning in Hands-Free Mode	2-8
Assemble the Stand	2-8
Scanning with Intellistand	2-9
Decode Zone	2-11

Chapter 3. Maintenance, Troubleshooting & Technical Specifications

Introduction	3-3
Maintenance	3-3
Scanner	3-3
Cradle	3-3
Troubleshooting	3-4
Technical Specifications	3-7
Cradle Signal Descriptions	3-10

Chapter 4. Radio Communications

Introduction	4-3
Scanning Sequence Examples	4-3
Errors While Scanning	4-3
Radio Communications Parameter Defaults	4-4
Wireless Beeper Definitions	4-5
Radio Communications Host Types	4-6
HID Host Parameters	4-8
HID Country Keyboard Types (Country Codes)	4-8
HID Keyboard Keystroke Delay	4-10
HID CAPS Lock Override	4-10
HID Ignore Unknown Characters	4-11
Emulate Keypad	4-11
HID Keyboard FN1 Substitution	4-12
HID Function Key Mapping	4-12
Simulated Caps Lock	4-13
Convert Case	4-13
Auto-reconnect Feature	4-14

Scanner(s) To Cradle Support	4-15
Modes of Operation	4-15
Point-to-Point Communication	4-15
Multipoint-to-Point Communication	4-15
Pairing	4-16
Pairing Modes	4-16
Lock Override	4-17
Pairing Methods	4-17
Unpairing	4-18
Connection Maintenance Interval	4-18
Considerations	4-18
Bluetooth Technology Profile Support	4-21
Master/Slave Set Up	4-21
Master	4-21
Slave	4-21
Pairing Bar Code Format	4-21
Bluetooth Security	4-22
Authentication	4-22
PIN Code	4-22
Encryption	4-23

Chapter 5. User Preferences

Introduction	5-3
Scanning Sequence Examples	5-3
Errors While Scanning	5-3
User Preferences Parameter Defaults	5-4
User Preferences	5-5
Default Parameters	5-5
Beeper Tone	5-6
Beeper Volume	5-6
Power Mode	5-7
Time Delay to Reduced Power Mode	5-7
Scan Pattern	5-8
Scan Line Width	5-9
Laser On Time	5-9
Beep After Good Decode	5-10
Transmit Code ID Character	5-10
Prefix/Suffix Values	5-11
Scan Data Transmission Format	5-11
FN1 Substitution Values	5-13
Transmit "No Read" Message	5-13
Synapse Interface	5-14
Batch Mode	5-15
Modes of Operation	5-15

Chapter 6. Keyboard Wedge Interface

Introduction	6-3
Connecting a Keyboard Wedge Interface	6-4
Keyboard Wedge Parameter Defaults	6-5
Keyboard Wedge Host Parameters	6-6
Keyboard Wedge Host Types	6-6
Keyboard Wedge Country Types (Country Codes)	6-7
Ignore Unknown Characters	6-8
Keystroke Delay	6-9
Intra-Keystroke Delay	6-9
Alternate Numeric Keypad Emulation	6-10
Caps Lock On	6-10
Caps Lock Override	6-10
Convert Wedge Data	6-11
Function Key Mapping	6-11
FN1 Substitution	6-12
Send Make and Break	6-12
Keyboard Maps	6-13
ASCII Character Set for Keyboard Wedge	6-14

Chapter 7. RS-232 Interface

Introduction	7-3
Connecting an RS-232 Interface	7-4
RS-232 Parameter Defaults	7-5
RS-232 Host Parameters	7-6
RS-232 Host Types	7-8
Baud Rate	7-9
Parity	7-10
Stop Bit Select	7-11
Data Bits (ASCII Format)	7-11
Check Receive Errors	7-12
Hardware Handshaking	7-12
Software Handshaking	7-14
Host Serial Response Time-out	7-15
RTS Line State	7-16
Beep on <BEL>	7-16
Intercharacter Delay	7-17
Nixdorf Beep/LED Options	7-18
Ignore Unknown Characters	7-18
ASCII Character Set for RS-232	7-19

Chapter 8. *USB Interface*

Introduction	8-3
Connecting a USB Interface	8-4
USB Parameter Defaults	8-5
USB Host Parameters	8-6
USB Device Type	8-6
USB Country Keyboard Types (Country Codes)	8-7
USB Keystroke Delay	8-9
USB CAPS Lock Override	8-9
USB Ignore Unknown Characters	8-10
Emulate Keypad	8-10
USB Keyboard FN 1 Substitution	8-11
Function Key Mapping	8-11
Simulated Caps Lock	8-12
Convert Case	8-12
Optional USB Parameters	8-13
Ignore Beep	8-13
Ignore Bar Code Configuration	8-13
ASCII Character Set for USB	8-14

Chapter 9. *IBM Interface*

Introduction	9-3
Connecting to an IBM 468X/469X Host	9-4
IBM Parameter Defaults	9-5
IBM 468X/469X Host Parameters	9-6
Port Address	9-6
Convert Unknown to Code 39	9-7
Optional IBM Parameters	9-8
Ignore Beep	9-8
Ignore Bar Code Configuration	9-8

Chapter 10. *Wand Emulation Interface*

Introduction	10-3
Connecting Using Wand Emulation	10-4
Wand Emulation Parameter Defaults	10-5
Wand Emulation Host Parameters	10-6
Wand Emulation Host Types	10-6
Leading Margin (Quiet Zone)	10-7
Polarity	10-8
Ignore Unknown Characters	10-8
Convert All Bar Codes to Code 39	10-9
Convert Code 39 to Full ASCII	10-10

Chapter 11. Scanner Emulation Interface

Introduction	11-3
Connecting Using Scanner Emulation	11-4
Scanner Emulation Parameter Defaults	11-5
Scanner Emulation Host	11-6
Scanner Emulation Host Parameters	11-6
Beep Style	11-6
Parameter Pass-Through	11-7
Convert Newer Code Types	11-7
Module Width	11-8
Convert All Bar Codes to Code 39	11-8
Code 39 Full ASCII Conversion	11-8
Transmission Timeout	11-9
Ignore Unknown Characters	11-10
Leading Margin	11-10
Check For Decode LED	11-11

Chapter 12. 123Scan

Introduction	12-3
Communication with 123Scan	12-3
123Scan requirements	12-3
123Scan Parameter	12-3

Chapter 13. Symbologies

Introduction	13-5
Scanning Sequence Examples	13-5
Errors While Scanning	13-5
Symbology Parameter Defaults	13-6
UPC/EAN	13-9
Enable/Disable UPC-A/UPC-E	13-9
Enable/Disable UPC-E1	13-10
Enable/Disable EAN-13/EAN-8	13-10
Enable/Disable Bookland EAN	13-11
Decode UPC/EAN/JAN Supplementals	13-11
UPC/EAN/JAN Supplemental Redundancy	13-13
Transmit UPC-A Check Digit	13-13
Transmit UPC-E Check Digit	13-13
Transmit UPC-E1 Check Digit	13-14
UPC-A Preamble	13-14
UPC-E Preamble	13-15
UPC-E1 Preamble	13-16
Convert UPC-E to UPC-A	13-16
Convert UPC-E1 to UPC-A	13-17
EAN-8/JAN-8 Extend	13-17
UCC Coupon Extended Code	13-18
Code 128	13-19
Enable/Disable Code 128	13-19

Enable/Disable UCC/EAN-128	13-19
Enable/Disable ISBT 128	13-20
Code 39	13-21
Enable/Disable Code 39	13-21
Enable/Disable Trioptic Code 39	13-21
Convert Code 39 to Code 32	13-22
Code 32 Prefix	13-22
Set Lengths for Code 39	13-23
Code 39 Check Digit Verification	13-24
Transmit Code 39 Check Digit	13-24
Code 39 Full ASCII Conversion	13-25
Code 39 Buffering (Scan & Store)	13-25
Buffer Data	13-26
Clear Transmission Buffer	13-27
Transmit Buffer	13-27
Overfilling Transmission Buffer	13-28
Attempt to Transmit an Empty Buffer	13-28
Code 93	13-29
Enable/Disable Code 93	13-29
Set Lengths for Code 93	13-29
Code 11	13-31
Code 11	13-31
Set Lengths for Code 11	13-31
Code 11 Check Digit Verification	13-33
Transmit Code 11 Check Digits	13-33
Interleaved 2 of 5 (ITF)	13-34
Enable/Disable Interleaved 2 of 5	13-34
Set Lengths for Interleaved 2 of 5	13-34
I 2 of 5 Check Digit Verification	13-35
Transmit I 2 of 5 Check Digit	13-36
Convert I 2 of 5 to EAN-13	13-36
Discrete 2 of 5 (DTF)	13-37
Enable/Disable Discrete 2 of 5	13-37
Set Lengths for Discrete 2 of 5	13-37
Chinese 2 of 5	13-39
Enable/Disable Chinese 2 of 5	13-39
Codabar (NW - 7)	13-40
Enable/Disable Codabar	13-40
Set Lengths for Codabar	13-40
CLSI Editing	13-41
NOTIS Editing	13-42
MSI	13-43
Enable/Disable MSI	13-43
Set Lengths for MSI	13-43
MSI Check Digits	13-44
Transmit MSI Check Digit(s)	13-45
MSI Check Digit Algorithm	13-45
RSS (Reduced Space Symbology)	13-46

Convert RSS to UPC/EAN 13-47

Symbology - Specific Security Levels 13-48

 Redundancy Level 13-48

 Redundancy Level 1 13-48

 Redundancy Level 2 13-48

 Redundancy Level 3 13-48

 Redundancy Level 4 13-48

 Security Level 13-50

 Bi-directional Redundancy 13-51

Symbology - Intercharacter Gap 13-52

Appendix A. Standard Default Parameters

Appendix B. Programming Reference

Symbol Code Identifiers B-3

AIM Code Identifiers B-4

Appendix C. Sample Bar Codes

Code 39 C-3

UPC/EAN C-3

 UPC-A, 100% C-3

 EAN-13, 100% C-3

Code 128 C-3

Interleaved 2 of 5 C-4

RSS C-4

 RSS C-4

 RSS-14 C-5

Appendix D. Numeric Bar Codes

Numeric Bar Codes D-3

Cancel D-4

Appendix E. Alphanumeric Bar Codes

Alphanumeric Keyboard E-3

Appendix F. ASCII Character Sets

Glossary

Index

About This Guide

Introduction	xvii
Chapter Descriptionsxvii
Notational Conventionsxvii
Related Publications	xviii
Service Information	xviii
Symbol Support Center	xviii

Introduction

The *LS4278 Product Reference Guide* provides general instructions for setting up, operating, maintaining, and troubleshooting the LS4278 scanner and cradles.

Chapter Descriptions

- [Chapter 1, Getting Started](#) provides a product overview, unpacking instructions, and cable connection information.
- [Chapter 2, Scanning](#) describes parts of the scanner, beeper and LED definitions, and how to use the scanner in hand-held and hands-free modes.
- [Chapter 3, Maintenance, Troubleshooting & Technical Specifications](#) provides information on how to care for the scanner and cradle, troubleshooting, and technical specifications.
- [Chapter , Introduction 4-3](#) provides information about the modes of operation and features available for wireless communication. This chapter also includes programming bar codes to configure the scanner.
- [Chapter 5, User Preferences](#) provides programming bar codes for selecting user preference features for the scanner and commonly used bar codes to customize how the data is transmitted to the host device.
- [Chapter 6, Keyboard Wedge Interface](#) provides information for setting up the scanner and cradle for Keyboard Wedge operation.
- [Chapter 7, RS-232 Interface](#) provides information for setting up the scanner and cradle for RS-232 operation.
- [Chapter 8, USB Interface](#) provides information for setting up the scanner and cradle for USB operation.
- [Chapter 9, IBM Interface](#) provides all information for setting up the scanner and cradle with IBM 468X/469X POS systems.
- [Chapter 10, Wand Emulation Interface](#) provides all information for setting up the scanner and cradle for Wand Emulation operation.
- [Chapter 11, Scanner Emulation Interface](#) provides information for setting up the scanner and cradle for Scanner Emulation operation.
- [Chapter 12, 123Scan](#) (PC based scanner configuration tool) provides the bar code that must be scanned to communicate with the 123Scan program.
- [Chapter 13, Symbologies](#) describes all symbology features and provides the programming bar codes necessary for selecting these features for the scanner.
- [Appendix A, Standard Default Parameters](#) provides a table of all host devices and miscellaneous scanner defaults.
- [Appendix B, Programming Reference](#) provides a table of AIM code identifiers, ASCII character conversions, and keyboard maps.
- [Appendix C, Sample Bar Codes](#) includes sample bar codes.
- [Appendix D, Numeric Bar Codes](#) includes the numeric bar codes to scan for parameters requiring specific numeric values.
- [Appendix F, ASCII Character Sets](#) provides ASCII character value tables.

Notational Conventions

The following conventions are used in this document:

- Bullets (●) indicate:
 - action items
 - lists of alternatives
 - lists of required steps that are not necessarily sequential.
- Sequential lists (e.g., those that describe step-by-step procedures) appear as numbered lists.

- Throughout the programming bar code menus, asterisks (*) are used to denote default parameter settings.



* Indicates Default ——— * **Baud Rate 9600** ——— Feature/Option

Related Publications

The *LS4278 Quick Reference Guide* (p/n 72-69835-xx) provides general information to help the user get started with the scanner. It includes basic operation instructions and start up bar codes.

The *STB4208/4278 Cradle Quick Reference Guide* (p/n 72-71010-xx) provides information to help the user set up and use the charge only and host interface cradles. It includes set up and mounting instructions.

For the latest versions of the *LS4278 Quick Reference Guide* and the *LS4278 Product Reference Guide* go to:
<http://www.symbol.com/manuals>.

Service Information

If you have a problem with your equipment, contact the [Symbol Support Center](#). Before calling, have the model number, serial number, and several bar code symbols at hand.

Call the Support Center from a phone near the scanning equipment so that the service person can try to talk you through your problem. If the equipment is found to be working properly and the problem is symbol readability, the Support Center will request samples of your bar codes for analysis at our plant.

If your problem cannot be solved over the phone, you may need to return your equipment for servicing. If that is necessary, you will be given specific directions.



Symbol Technologies is not responsible for any damages incurred during shipment if the approved shipping container is not used. Shipping the units improperly can possibly void the warranty. If the original shipping container was not kept, contact Symbol to have another sent to you.

Symbol Support Center

For service information, warranty information or technical assistance contact or call the Symbol Support Center listed below. For the latest service information go to <http://www.symbol.com>.

United States

Symbol Technologies, Inc.
One Symbol Plaza
Holtsville, New York 11742-1300
1-800-653-5350

Canada

Symbol Technologies Canada, Inc.
5180 Orbitor Drive
Mississauga, Ontario L4W 5L9
905-629-7226

United Kingdom

Symbol Technologies
 Symbol Place
 Winnersh Triangle, Berkshire RG41 5TP
 United Kingdom
 0800 328 2424 (Inside UK)
 +44 118 945 7529 (Outside UK)

Australia

Symbol Technologies Pty. Ltd.
 432 St. Kilda Road
 Melbourne, Victoria 3004
 1-800-672-906 (Inside Australia)
 +61-3-9866-6044 (Outside Australia)

Denmark/Danmark

Symbol Technologies AS
 Dr. Neergaardsvej 3
 2970 Hørsholm
 7020-1718 (Inside Denmark)
 +45-7020-1718 (Outside Denmark)

Finland/Suomi

Oy Symbol Technologies
 Kaupintie 8 A 6
 FIN-00440 Helsinki, Finland
 9 5407 580 (Inside Finland)
 +358 9 5407 580 (Outside Finland)

Germany/Deutschland

Symbol Technologies GmbH
 Waldstrasse 66
 D-63128 Dietzenbach, Germany
 6074-49020 (Inside Germany)
 +49-6074-49020 (Outside Germany)

Latin America Support

Latin America Headquarters
 Latin America & The Caribbean
 2730 University Drive
 Coral Springs, Florida 33065
 United States
 +1.954.255.2610 (Inside Latin America & The Caribbean)
 1-800-347-0178 (Inside United States)
 Fax: +1.954.340.9454

Asia/Pacific

Symbol Technologies Asia, Inc.
 230 Victoria Street #04-05
 Bugis Junction Office Tower
 Singapore 188024
 337-6588 (Inside Singapore)
 +65-337-6588 (Outside Singapore)

Austria/Österreich

Symbol Technologies Austria GmbH
 Prinz-Eugen Strasse 70 / 2.Haus
 1040 Vienna, Austria
 01-5055794-0 (Inside Austria)
 +43-1-5055794-0 (Outside Austria)

Europe/Mid-East Distributor Operations

Contact your local distributor or call
 +44 118 945 7360

France

Symbol Technologies France
 Centre d'Affaire d'Antony
 3 Rue de la Renaissance
 92184 Antony Cedex, France
 01-40-96-52-21 (Inside France)
 +33-1-40-96-52-50 (Outside France)

Italy/Italia

Symbol Technologies Italia S.R.L.
 Via Cristoforo Colombo, 49
 20090 Trezzano S/N Naviglio
 Milano, Italy
 2-484441 (Inside Italy)
 +39-02-484441 (Outside Italy)

Mexico/México

Symbol Technologies Mexico Ltd.
 Boulevard Manuel Ávila Camacho # 24- 9 Piso
 Col. Lomas de Chapultepec
 México DF: CP 11000
 Mexico City, DF, Mexico
 5-520-1835 (Inside Mexico)
 +52-5-520-1835 (Outside Mexico)

Netherlands/Nederland

Symbol Technologies
Kerkplein 2, 7051 CX
Postbus 24 7050 AA
Varsseveld, Netherlands
315-271700 (Inside Netherlands)
+31-315-271700 (Outside Netherlands)

South Africa

Symbol Technologies Africa Inc.
Block B2
Rutherford Estate
1 Scott Street
Waverly 2090 Johannesburg
Republic of South Africa
11-809 5311 (Inside South Africa)
+27-11-809 5311 (Outside South Africa)

Sweden/Sverige

"Letter" address:
Symbol Technologies AB
Box 1354
S-171 26 SOLNA
Sweden
Visit/shipping address:
Symbol Technologies AB
Solna Strandväg 78
S-171 54 SOLNA
Sweden
Switchboard: 08 445 29 00 (domestic)
Call Center: +46 8 445 29 29 (international)
Support E-Mail: Sweden.Support@se.symbol.com

Norway/Norge

Symbol's registered and mailing address:
Symbol Technologies Norway
Helsfyr Panorama
Innspurten 9
Oslo N-0663
Symbol's repair depot and shipping address:
Symbol Technologies Norway
Enebakkveien 123
N-0680 OSLO, Norway
+47 2232 4375

Spain/España

Symbol Technologies S.L.
Avenida de Bruselas, 22
Edificio Sauce
Alcobendas, Madrid 28108
Spain
+913244000 (Inside Spain)
+34-9-1-320-39-09 (Outside Spain)

If you purchased your Symbol product from a Symbol Business Partner, contact that Business Partner for service.

1

Getting Started

Introduction	1-3
Unpacking the Scanner and Cradle	1-4
Parts	1-5
Scanner Parts	1-5
Cradle Parts	1-6
Scanner Cradle	1-8
Connecting the Cradle	1-8
Supplying Power to the Cradle	1-9
Using the USB Interface to Supply Power	1-9
Connecting a Synapse Cable Interface	1-9
Lost Connection to Host	1-10
Mounting the Cradle	1-10
Replacing the Scanner Battery	1-11
Charging the Scanner Battery	1-12
Charging LED	1-12
Inserting the Scanner in the Cradle	1-12
Horizontal Cradle Mount	1-12
Vertical Cradle Mount	1-13
Radio Communications	1-13
Configuring the Scanner	1-13
Accessories	1-14
Lanyard	1-14

Introduction

The LS4278 combines excellent scanning performance and advanced ergonomics to provide the best value in a lightweight laser scanner. Whether used as a hand-held scanner or in hands-free mode in a stand, the scanner ensures comfort and ease of use for extended periods of time.



Figure 1-1. LS 4278 Scanner

In addition to single-line laser scanning, the scanner supports multi-line rastering. Multi-line rastering allows the scanner to capture stacked RSS codes and increases angular tolerances, minimizing product orientation and hand movements. Multi-line rastering also allows the scanner to read poor quality bar codes. For more information about scanning modes and stacked RSS codes, see [Scan Pattern on page 5-8](#) and [RSS on page C-4](#).



The scanner does not currently support PDF-417 bar codes and its variants.

Note

This STB4278 cradle supports the following interfaces:

- Keyboard Wedge connection to a host. The host interprets scanned data as keystrokes. This interface supports the following international keyboards (for Windows[®] environment): North America, German, French, French Canadian, Spanish, Italian, Swedish, UK English, Portuguese-Brazilian, and Japanese.
- Standard RS-232 connection to a host. Scan bar code menus to set up proper communication of the cradle with the host.
- USB connection to a host. The cradle autodetects a USB host and defaults to the HID keyboard interface type. Select other USB interface types by scanning programming bar code menus. This interface supports the following international keyboards (for Windows[®] environment): North America, German, French, French Canadian, Spanish, Italian, Swedish, UK English, Portuguese-Brazilian, and Japanese.
- Connection to IBM[®] 468X/469X hosts. Scan bar code menus to set up communication of the cradle with the IBM terminal.

- Wand Emulation connection to a host. The cradle is connected to a portable data terminal, a controller, or host which collects the data as wand data and decodes it.
- Scanner Emulation connection to a host. The cradle is connected to a portable data terminal, a controller which collects the data and interprets it for the host.
- Synapse capability which allows connection to a wide variety of host systems using a Synapse and Synapse adapter cable. The cradle autodetects the host.
- Configuration via 123Scan.

Unpacking the Scanner and Cradle

Remove the scanner and cradle from their respective packing and inspect for damage. If the scanner or cradle was damaged in transit, call the [Symbol Support Center](#) at one of the telephone numbers listed on [page xvi](#). **KEEP THE PACKING**. It is the approved shipping container and should be used if the equipment ever needs to be return for servicing.

Parts

Scanner Parts

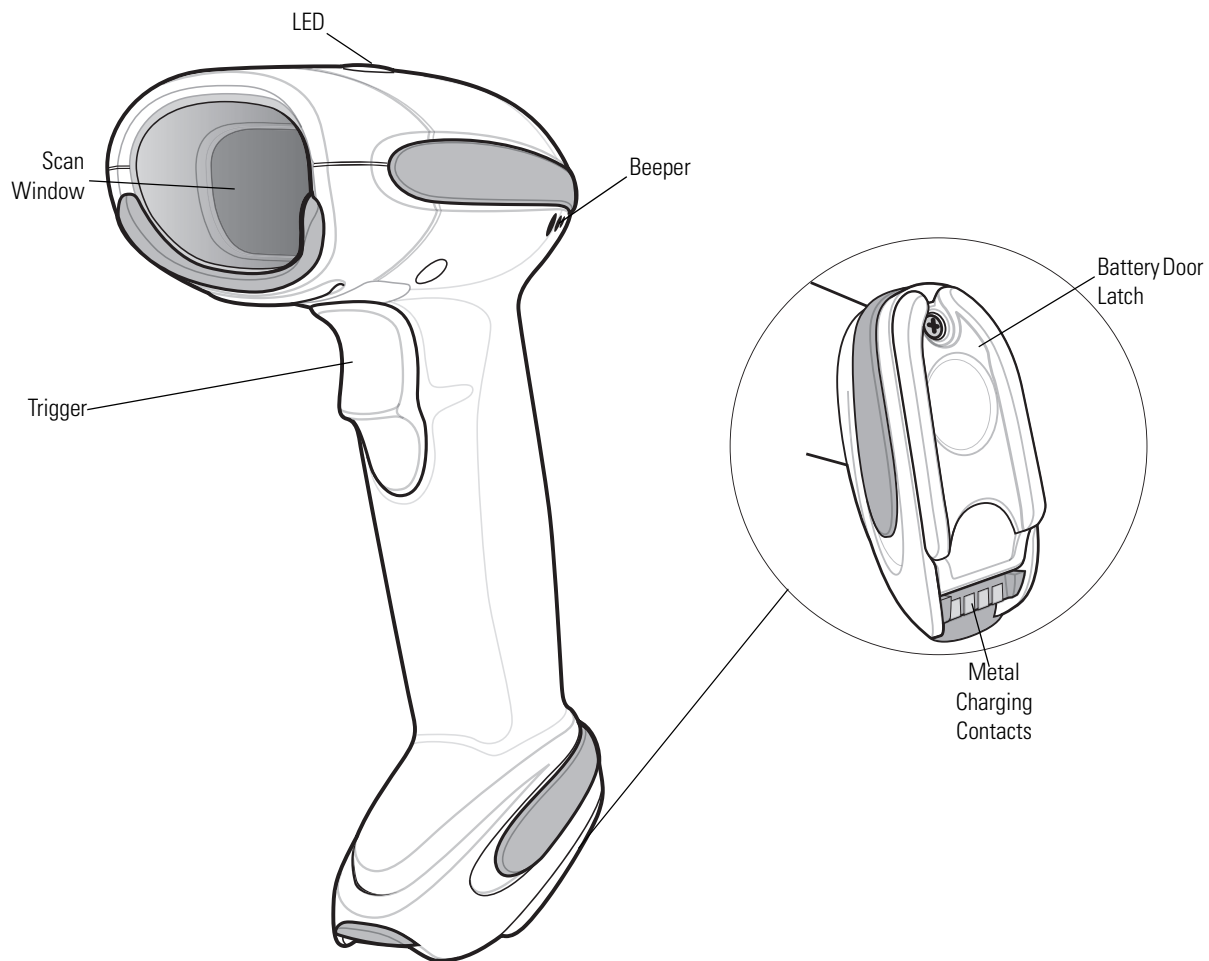

Figure 1-2. Parts of the Scanner

Cradle Parts

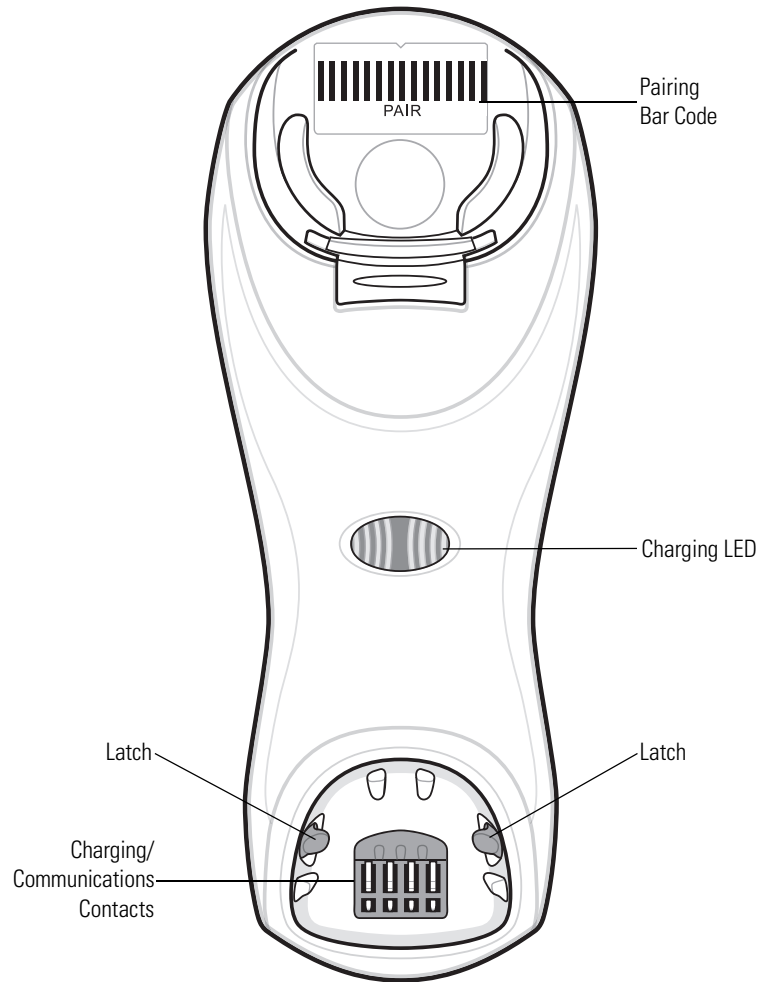

Figure 1-3. Cradle Front View

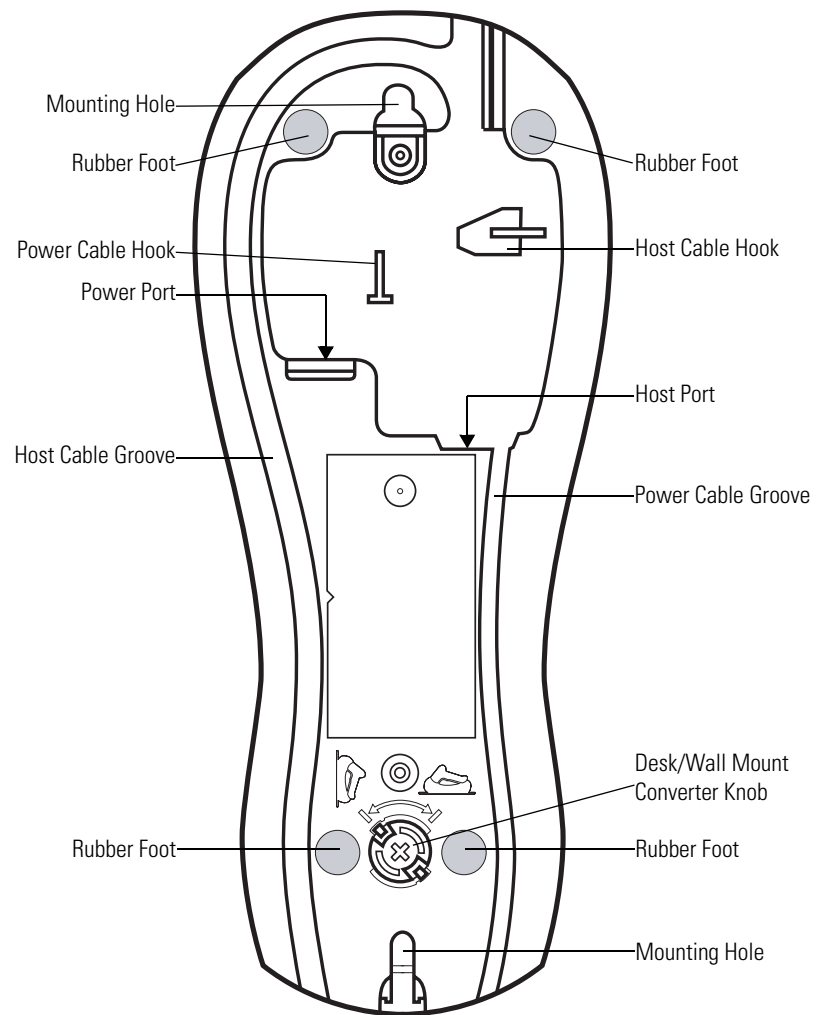

Figure 1-4. Cradle Back View

Scanner Cradle

The scanner cradle serves as a stand, charger, and host interface for the scanner. The cradle sits on a desktop or mounts on a vertical surface (such as a wall). For more information about mounting options and procedures, refer to the documentation included with the cradle.

There are two versions of the cradle:

- **Charging cradle with radio:** When the cordless scanner is paired to the cradle, all communication between the scanner and the host computer is accomplished through the cradle. Each bar code contains programming instructions or other data unique to the bar code pattern. The scanner is paired to the cradle and transmits bar code data to the cradle via Bluetooth Technology Profile Support. The cradle then sends that information via an interface cable to the host computer for interpretation.
- **Charge-only cradle:** This cradle serves as a stand and battery charger. It does not contain a radio and has no communication capability.



For more information about communication between the scanner, cradle and host, see [Chapter , Introduction 4-3](#).

Connecting the Cradle

Important: Connect the interface cable and power supply (if necessary) in the following order to ensure proper operation of the scanner and cradle:

1. If a power supply is connected to the cradle, disconnect it. See [Figure 1-5](#).
2. If using an interface cable, insert the cable into the cradle's host port.
3. If using a power supply that connects to the interface cable, insert this power supply into the power connector on the interface cable, and the other end to an AC supply.
4. Insert the other end of the interface cable into the appropriate port on the host computer (see the specific host chapter for information on host connections).
5. If using an external power supply (if required by the interface, or to allow fast charging of the scanner), insert the power cable into the power port on the back of the cradle, and connect the power supply to an approved AC supply (see the *STB4208/4278 Cradle Quick Reference Guide* for more information).

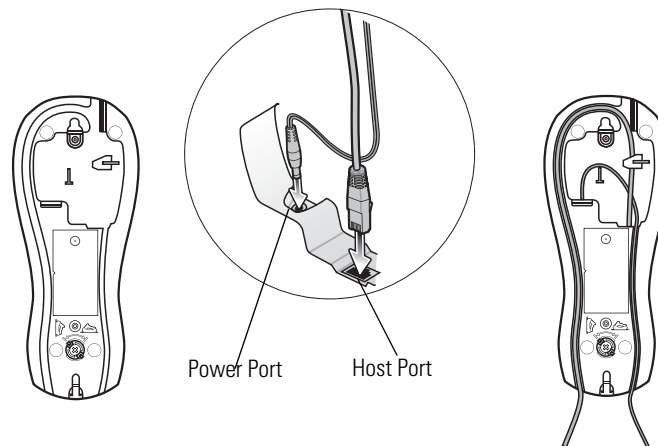

Figure 1-5. Connecting the Cables to the Cradle

6. If applicable, thread the interface cable over the cable support hook and run the host and power cables into their respective cable grooves.
7. Mount the cradle, as necessary. (For information on mounting the cradle, refer to the documentation included with the cradle.)



Note

Disconnect the power supply before changing host cables, or the cradle may not recognize the new host.

Different cables are required for different hosts. The connectors illustrated in each host chapter are examples only. The connectors may be different from those illustrated, but the steps to connect the cradle remain the same.

Supplying Power to the Cradle

The cradle receives power from one of two sources:

- An external power supply.
- When connected to the host through a host cable that supplies power.

The cradle detects whether the host or the external supply is supplying power. It always draws power from the external supply when available, regardless of the presence of power from a host.

Using the USB Interface to Supply Power

When the cradle is connected to the host via the USB interface, it can be powered by the USB port instead of an external power supply. Powering from a USB host limits charging. The scanner charges at a slower rate than when charging from an external power supply.



Note

The radio link functions normally when the cradle draws power from a USB host.

Connecting a Synapse Cable Interface



Refer to the Synapse Interface Guide provided with the Synapse cable for detailed setup instructions.

Symbol's Synapse Smart Cables enable interfacing to a variety of hosts. The appropriate Synapse cable has the built-in intelligence to detect the host to which it is connected.

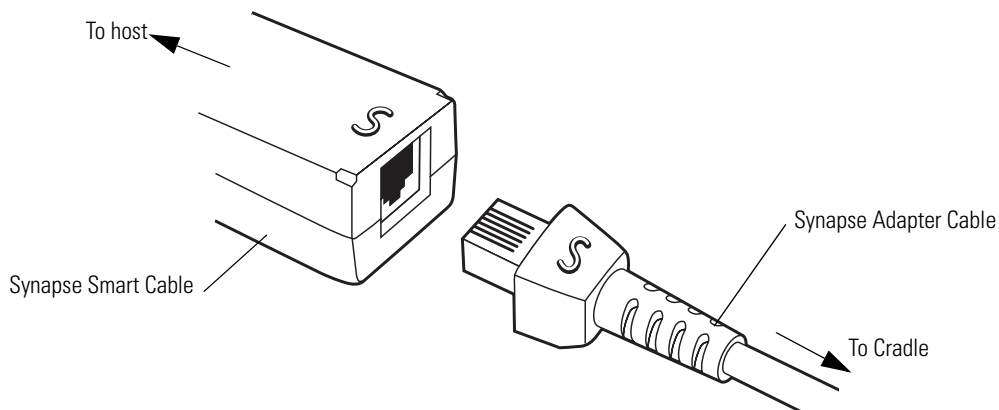

Figure 1-6. Synapse Cable Connection

1. Insert the Synapse adapter cable (p/n 25-32463-xx) into the host port on the bottom of the cradle, as described in [Connecting the Cradle on page 1-8](#).
2. Align the 'S' on the Synapse adapter cable with the 'S' on the Synapse Smart Cable and plug the cable in.
3. Connect the other end of the Synapse Smart Cable to the host.

Lost Connection to Host

If scanned data does not transmit to the cradle's host, ensure that all cables are firmly inserted and the power supply is connected to an appropriate AC outlet. If scanned data still does not transmit to the host, reestablish a connection with the host:

1. Disconnect the power supply from the cradle.
2. Disconnect the host interface cable from the cradle.
3. Wait three seconds.
4. Reconnect the host interface cable to the cradle.
5. Reconnect the power supply to the cradle, if required.
6. Reestablish pairing with the cradle by scanning the pairing bar code.



The STB4278 does not always require a power supply whereas the STB4208 always requires a power supply.

Mounting the Cradle

For information on mounting the cradle, refer to the documentation included with the cradle.

Replacing the Scanner Battery

The battery is installed in the cordless scanner by the factory and resides in a chamber in the scanner handle. To replace the battery:

1. Insert a Phillips screwdriver in the screw at the base of the scanner, then turn the screw counterclockwise to release the latch.
2. Remove the latch.
3. If a battery is already installed, turn the scanner upright to slide the battery out. Disconnect the battery connector clip.

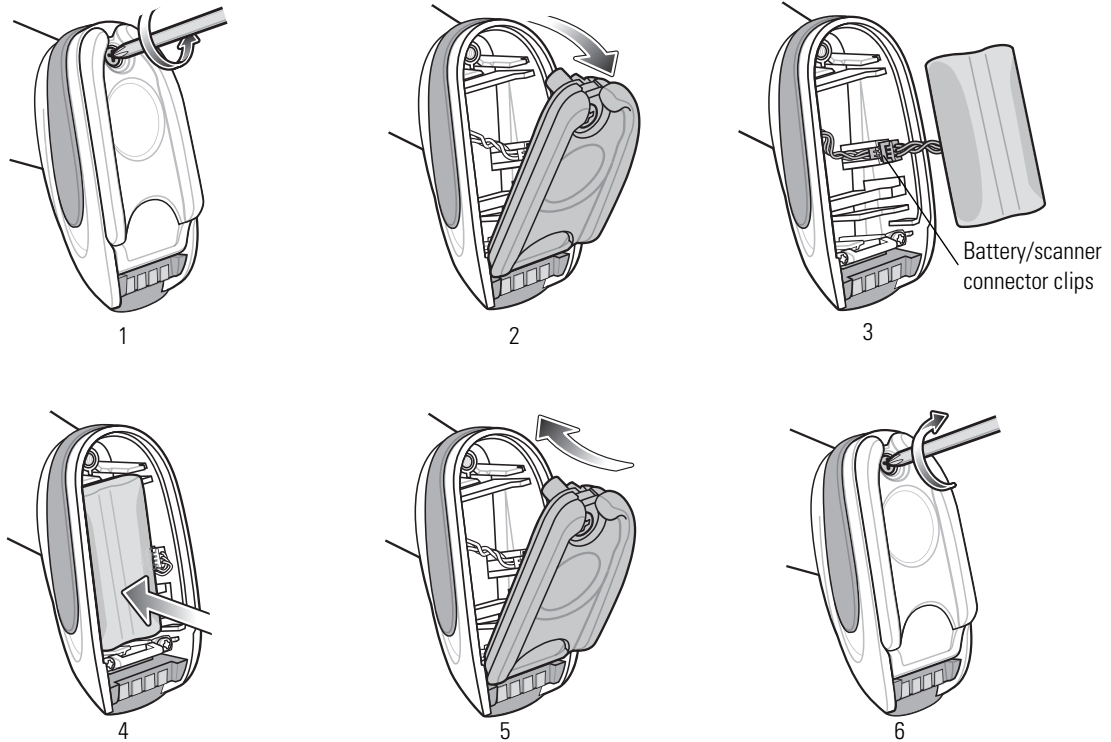

Figure 1-7. Inserting the Battery

4. With the contacts on the connector clips facing in the same direction, attach the new battery's connector clip to the connector clip in the base of the scanner.
5. Slide the new battery into the battery well and ensure the battery leads are visible. The battery should sit securely in the well.
6. Attach and close the latch.
7. Insert a Phillips screwdriver in the screw at the base of the scanner, press down gently, and turn the screw clockwise to lock the latch in place.

Charging the Scanner Battery

Fully charge the scanner battery before using the scanner for the first time. To charge the scanner battery, place the scanner in the cradle, ensuring that the metal contacts on the bottom of the scanner touch the contacts on the cradle. The battery begins charging when the scanner LED indicator starts flashing green. A complete charge of a fully discharged battery can take up to three hours using external power and up to five hours using non-external cable power.



To avoid a battery temperature fault, always charge the battery in the scanner within the recommended temperature of 32° to 104° F (0° to 40° C) nominal, 41° to 95° F (5° to 35° C) ideal.

Charging LED

When powered up, the cradle LED is always green. The scanner LED flashes a green during charging. See [Table 2-2 on page 2-4](#) for all charging LED indications.

Inserting the Scanner in the Cradle

Insert the scanner in the cradle so that the metal contacts on the bottom of the scanner handle touch the contacts on the cradle. Push the handle lightly to ensure a proper connection, engaging the contacts in the cradle and scanner. Ensure the desk/wall mount converter knob on the back of the cradle is in the correct position for the horizontal or vertical mounting.

Horizontal Cradle Mount

When mounting the cradle horizontally, where no fastening is necessary:

1. Ensure the rubber feet are attached to the cradle. These feet provide traction and prevent surface damage.
2. Ensure the desk/wall mount converter knob is in the position shown in [Figure 1-8](#).

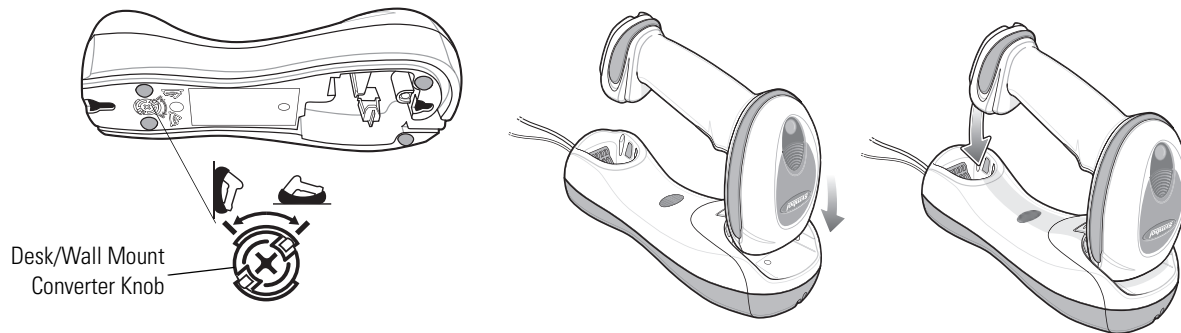

Figure 1-8. Horizontal Mount - Inserting the Scanner in the Cradle

Vertical Cradle Mount

When mounting the cradle vertically:

1. Ensure the rubber feet are attached to the cradle. These feet provide traction and prevent surface damage.
2. Ensure the convertible mount hook on the front of the cradle is inserted with the hook facing up. If not, remove and reverse the hook so that it is in position to secure the scanner in place. (See [Figure 1-3 on page 1-6](#) for the location of the convertible mount hook.)
3. Ensure the desk/wall mount converter knob is in the position shown in [Figure 1-9](#).

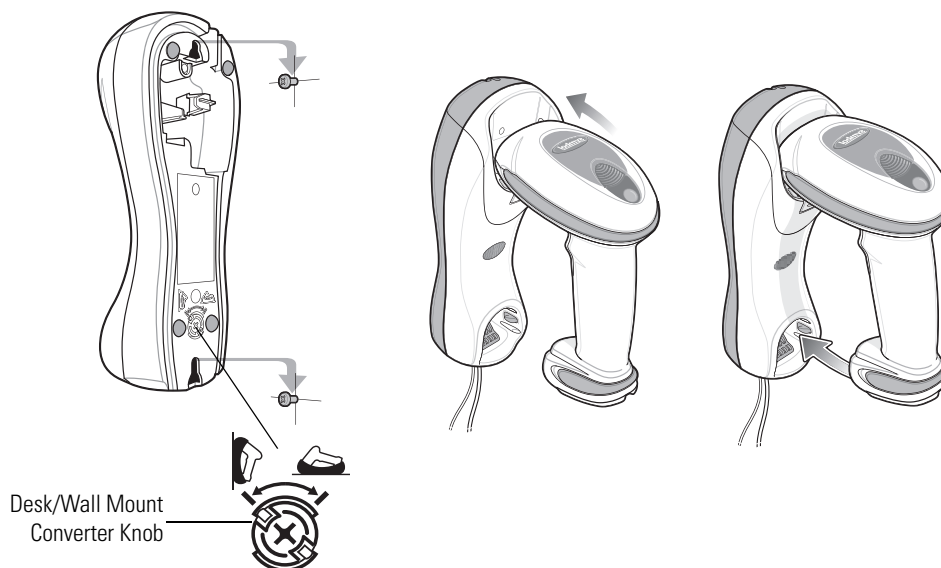

Figure 1-9. Vertical Mount - Inserting the Scanner in the Cradle



For your convenience, a wall mount bracket can be purchased from Symbol Technologies. For the appropriate measurements, and instructions on mounting the cradle, refer to the *STB4208/4278 Quick Reference Guide* (p/n 72-71010-xx).

Radio Communications

The scanner can communicate with remote devices via Bluetooth Technology Profile Support, or by pairing with a cradle. For radio communication parameters, detailed information about operational modes, Bluetooth Technology Profile Support and pairing, see [Chapter 4, Radio Communications](#).

Configuring the Scanner

Use the bar codes in this manual or the 123Scan configuration program to configure the scanner. See [Chapter 4, User Preferences](#) and each host chapter for information about programming the scanner using bar code menus. See [Chapter 11, 123Scan](#) to configure the scanner using this configuration program. 123Scan includes a help file.

Accessories

The scanner and cradle accessories include:

- Intellistand for scanning in hands-free mode. For information about set up and use of Intellistand, see [Scanning in Hands-Free Mode on page 2-8](#).
- Power supplies for applications that do not supply power over the host cable. See each host interface chapter for set up information.
- Wall-mount bracket for mounting the cradle vertically. Refer to the *STB4208/4278 Cradle Quick Reference Guide* (p/n 72-71010-xx) for a wall mounting template and installation instructions.
- Lanyard for wearing the scanner on a wrist.

Lanyard

The lanyard attaches to the inside of the scanner battery door latch.

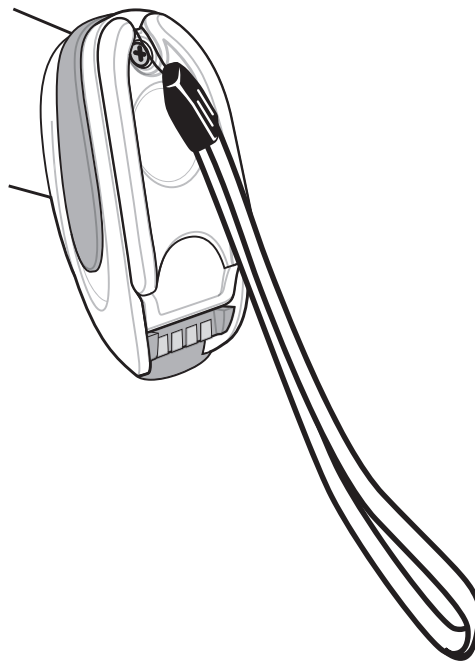

Figure 1-10. Attached Lanyard

To attach the lanyard:

1. Open the battery door latch as described in [Replacing the Scanner Battery on page 1-11](#). Do not remove the battery.
2. Hook the loop of the lanyard around the screw container inside the battery door latch, between the loop guides.

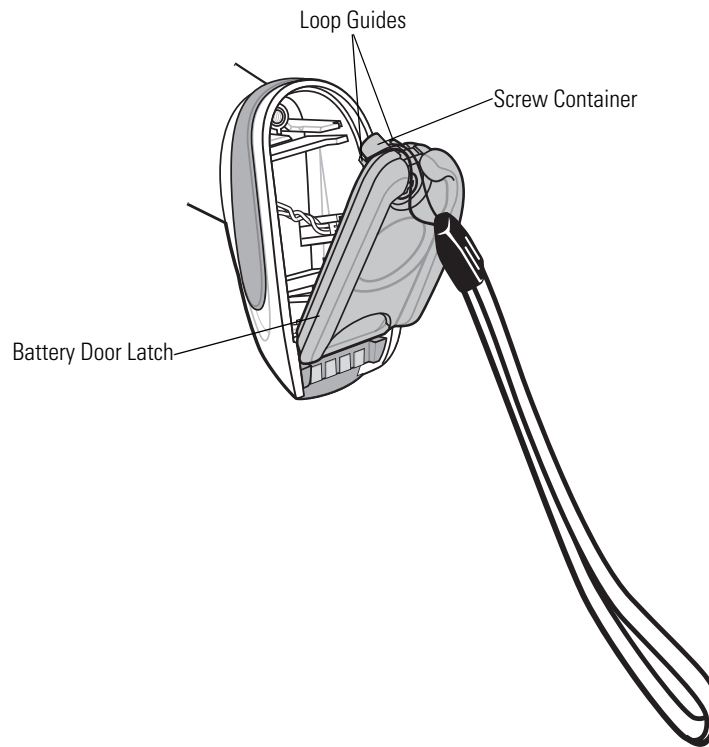

Figure 1-11. Attaching Lanyard

3. Close the battery door latch.
4. Tighten the screw.

2

Scanning

Introduction	2-3
Beeper Definitions	2-3
LED Definitions	2-4
Scanning in Hand-Held Mode	2-5
Aiming	2-6
Scanning in Hands-Free Mode	2-8
Assemble the Stand	2-8
Scanning with Intellistand	2-9
Decode Zone	2-11

Introduction

This chapter provides beeper and LED definitions, scanning techniques, general instructions and tips about scanning, and decode zone diagrams.

Beeper Definitions

The scanner issues different beep sequences and patterns to indicate status. [Table 2-1](#) defines beep sequences that occur during both normal scanning and while programming the scanner. (For additional beeper definitions, see [Wireless Beeper Definitions](#) on [page 4-15](#).)

Table 2-1. Standard Beeper Definitions

Beeper Sequence	Indication
Standard Use	
Low/medium/high beeps	Power up.
High beep	A bar code symbol was decoded (if decode beeper is enabled).
Four long low beeps	<ol style="list-style-type: none"> 1. A transmission error was detected in a scanned symbol. The data is ignored. This occurs if a unit is not properly configured. Check option setting. 2. When communicating with a cradle, the cradle acknowledges receipt of data. If the acknowledgment is not received, this transmission error beep sequence sounds. Data may still have been received by the host. Check the host system for receipt of transmitted data. If data was not received by the host, re-scan the bar code.
Five low long beeps	Conversion or format error.
Low/high/low/high beeps	Out of memory - unable to store a new bar code.
Low/high/low beeps	ADF transmit error.
High/high/high/low beeps	RS-232 receive error.
Parameter Menu Scanning	
Long low/long high beeps	Input error, incorrect bar code or Cancel scanned, wrong entry, incorrect bar code programming sequence; remain in program mode.
High/low beeps	Keyboard parameter selected. Enter value using bar code keypad.
High/low/high/low beeps	Successful program exit with change in the parameter setting.
Long low/long high/long low/long high beeps	Out of host parameter storage space. Scan Default Parameters on page 5-5 .
Wireless Operation	
High/low/high/low beeps	Pairing bar code scanned.
Low/high beeps	Bluetooth connection established.
High/low beeps	Bluetooth disconnection event. Note: When connected to a remote device using SPP or HID, if a disconnect beep sequence sounds immediately after a bar code is scanned, check the host device for receipt of transmitted data. It is possible that an attempt was made to transmit the last bar code scanned after the connection was lost.
Long low/long high beeps	Page timeout; remote device is out of range/not powered.
Long low/long high/long low/long high beeps	Connection attempt was rejected by remote device.
Code 39 Buffering	
High/low beeps	New Code 39 data was entered into the buffer.
Three long high beeps	Code 39 buffer is full.

Table 2-1. Standard Beeper Definitions (Continued)

Beeper Sequence	Indication
Low/high/low beeps	The Code 39 buffer was erased or there was an attempt to clear or transmit an empty buffer.
Low/high beeps	A successful transmission of buffered data.
Host Specific	
USB only	
Four high beeps	Scanner has not completed initialization. Wait several seconds and scan again.
Scanner gives a power-up beep after scanning a USB Device Type.	Communication with the bus must be established before the scanner can operate at the highest power level.
This power-up beep occurs more than once.	The USB bus may put the scanner in a state where power to the scanner is cycled on and off more than once. This is normal and usually happens when the host PC cold boots.
RS-232 only	
High beep	A <BEL> character is received and Beep on <BEL> is enabled.

LED Definitions

In addition to beeper sequences, the scanner communicates with the user using a two-color LED display. Table 2-2 defines LED colors that display during scanning.

Table 2-2. Standard LED Definitions

Scanning LED	Indication
Green Flash	A bar code was successfully decoded.
Charging LED	
Green - Slow Continuous Flash	Non-critical battery temperature fault. Battery is above or below normal operating temperature. If this occurs, do not use the scanner and move the scanner to a location within normal operating temperature. The scanner can remain in the cradle while the battery warms or cools to normal operating temperature. Note: For appropriate charging temperatures, see Table 3-3 on page 3-8 .
Green - Fast Continuous Flash	Scanner is charging.
Green - Solid	Scanner is fully charged.
Amber - Continuous Flash	Critical battery temperature fault. Battery is above or below normal operating temperature. If this occurs, do not use the scanner and move the scanner to a location within normal operating temperature. The scanner can remain in the cradle while the battery warms or cools to normal operating temperature. Note: For appropriate charging temperatures, see Table 3-3 on page 3-8 .

Scanning in Hand-Held Mode

To program the scanner, see the appropriate host chapter, [Chapter , Introduction 4-3](#) and [Chapter 13, Symbolologies](#). (In addition to the parameters included in the chapters mentioned, user preference and miscellaneous scanner option parameters are also available in this guide.)

To scan:

1. Aim the scanner at the bar code.
2. Press the trigger.

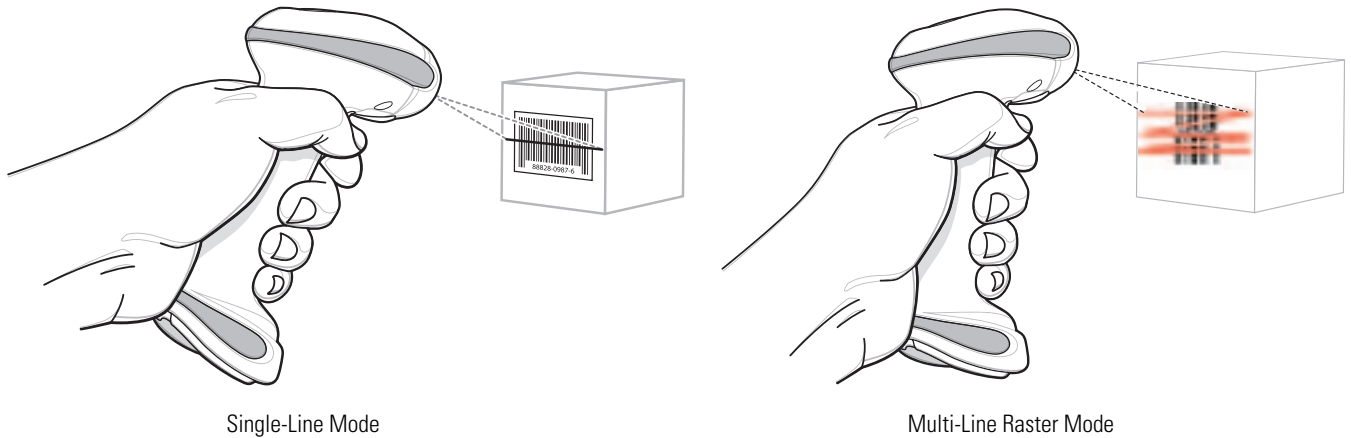

Figure 2-1. Scanning in Hand-Held Mode

3. Upon successful decode, the scanner beeps and the LED turns green. (For more information about beeper and LED definitions, see [Table 2-1](#) and [Table 2-2](#).)



Note

Scan line lengths vary depending on the scan line width selected (see [Scan Line Width on page 5-9](#)). A full scan line width is the default. Medium and short scan line widths are useful for scanning menus or pick-lists.

Aiming

On a typical UPC 100% hold the scanner between contact and 19 inches from the symbol (see [Decode Zone on page 2-11](#)). When scanning using a single-line scan mode, ensure the scan line crosses every bar and space of the symbol.



Figure 2-2. Acceptable and Incorrect Single-Line Aiming

When scanning using a multi-line scan mode, at least one scan line must cross every bar and space of the symbol.



Figure 2-3. Acceptable and Incorrect Multi-Line Aiming

Regardless of the scan mode, the scan line is smaller when the scanner is closer to the symbol and larger when it is farther from the symbol. Scan symbols with smaller bars or elements (mil size) closer to the scanner, and those with larger bars or elements (mil size) farther from the scanner.

Do not hold the scanner directly over the bar code. Laser light reflecting *directly* back into the scanner from the bar code is known as specular reflection. This specular reflection can make decoding difficult.



Note

Scan line lengths vary depending on the scan line width selected. A full scan line width is the default. Medium and short scan line widths are useful for scanning menus or pick-lists.

For more information about scan line widths and scanning modes, see [page 5-8](#) and [page 5-9](#), respectively.

The scanner can be tilted up to 65° forward or back and achieve a successful decode (Figure 2-4). Simple practice quickly shows what tolerances to work within.

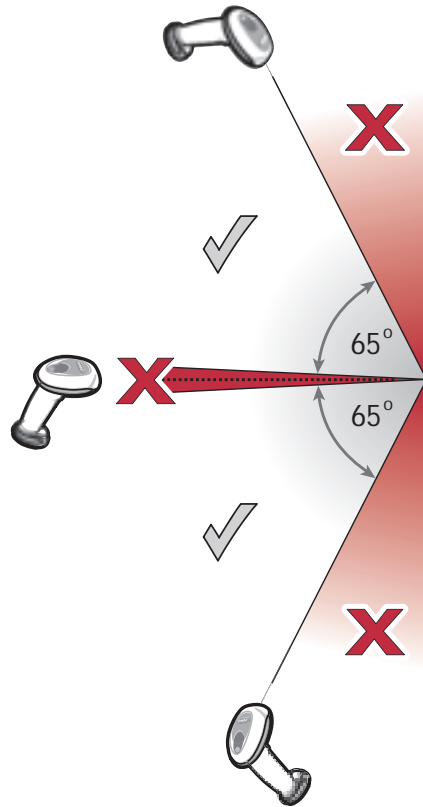

Figure 2-4. Maximum Tilt Angles and Dead Zone

Scanning in Hands-Free Mode

The optional Intellistand adds greater flexibility to scanning operation. When the scanner is seated in the stand's "cup," the scanner's built-in sensor places the scanner in hands-free mode. When the scanner is removed from the stand, it automatically switches modes to operate in its normal hand-held triggered mode.

Assemble the Stand

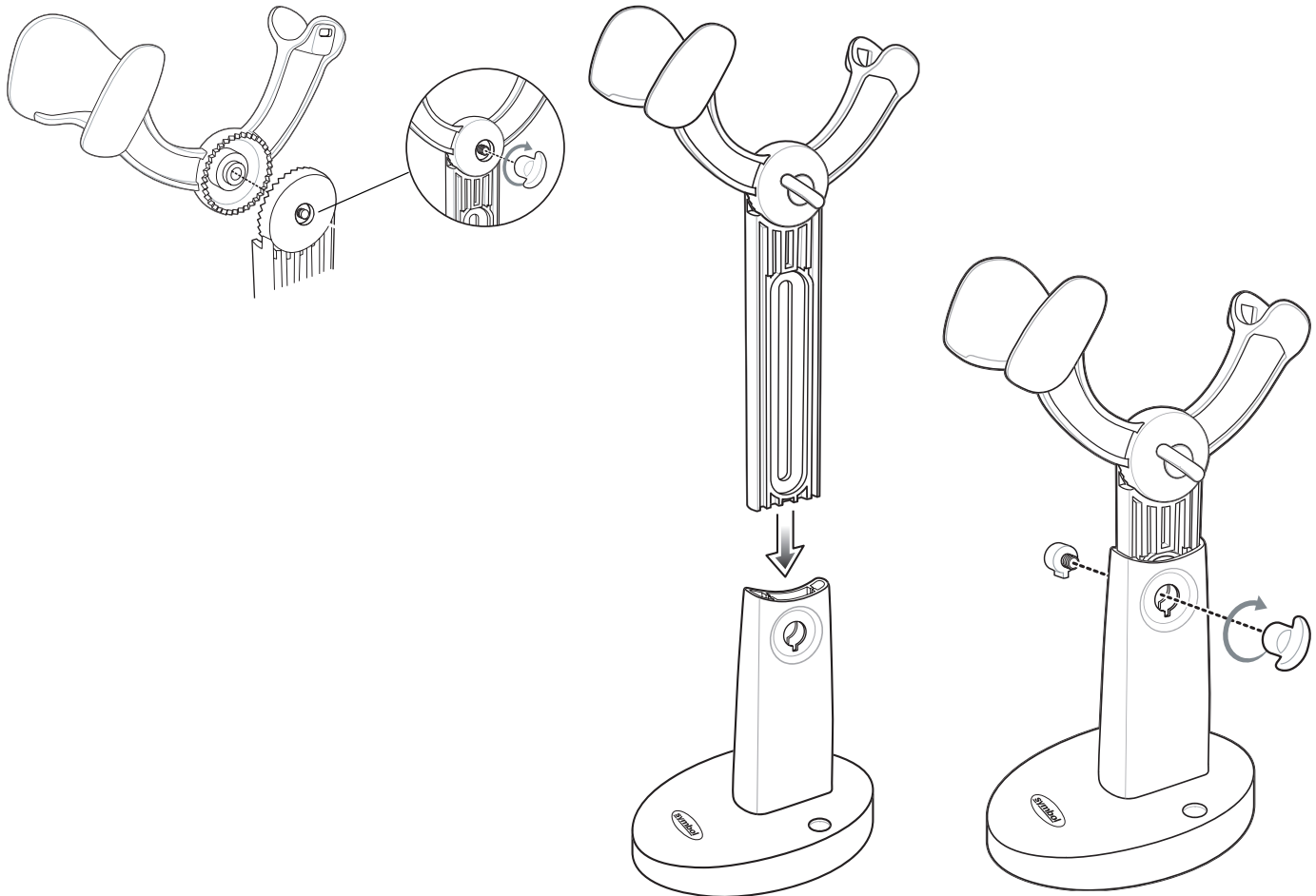

Figure 2-5. Assembling Intellistand

Scanning with Intellistand

When the scanner is placed in Intellistand, the scan pattern selected in hand-held triggered mode continues (see [Scan Pattern on page 5-8](#)).



Note

When the scanner is configured as a Master or Cradle Host and the Bluetooth connection to the remote device is lost, the scanner must be removed from Intellistand and re-paired to the remote device. To accomplish this, pull the trigger which engages the auto-reconnect feature, or scan the pairing bar code for the remote device.



CAUTION

When the scanner is not used for an extended period of time, place it in the cradle for charging. This prolongs battery life.

To operate the scanner in Intellistand:

1. Ensure the scanner is set up to communicate with the cradle, and the cradle is properly connected to the host and (see the appropriate host chapter for information on host connections).
2. Insert the scanner in Intellistand by placing the front of the scanner into the stand's "cup."

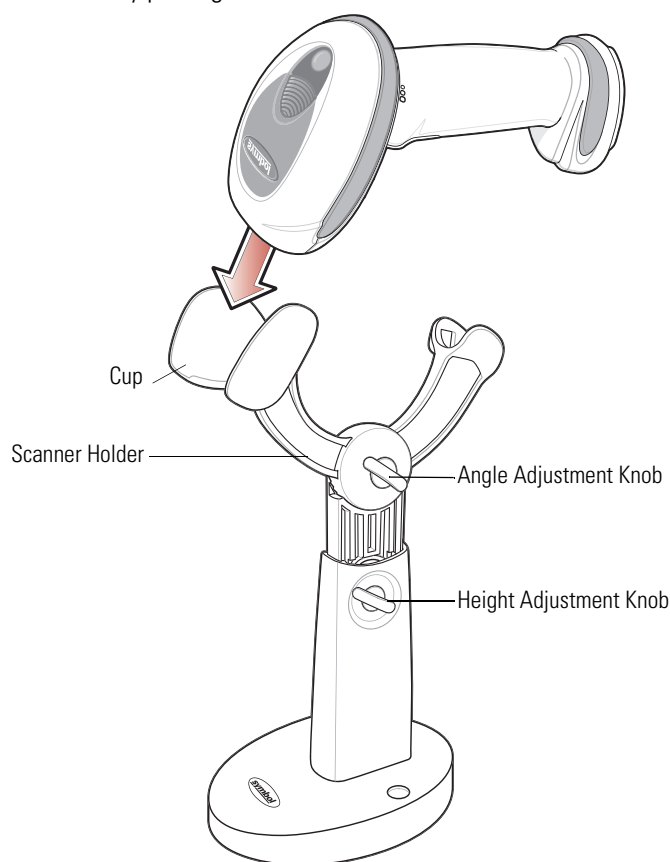

Figure 2-6. Inserting the Scanner in the Intellistand

3. Use the Intellistand's adjustment knobs to adjust the height and angle of the scanner.
4. Present the bar code.



When the bar code is in view, the scanner emits a full scan line. After a decode, the scan line blinks.

5. Upon successful decode, the scanner beeps and the LED turns green. For more information about beeper and LED definitions, see [Table 2-1](#) and [Table 2-2](#).

Decode Zone

Note: Typical performance at 73° F (23° C) on high quality symbols in normal room light.

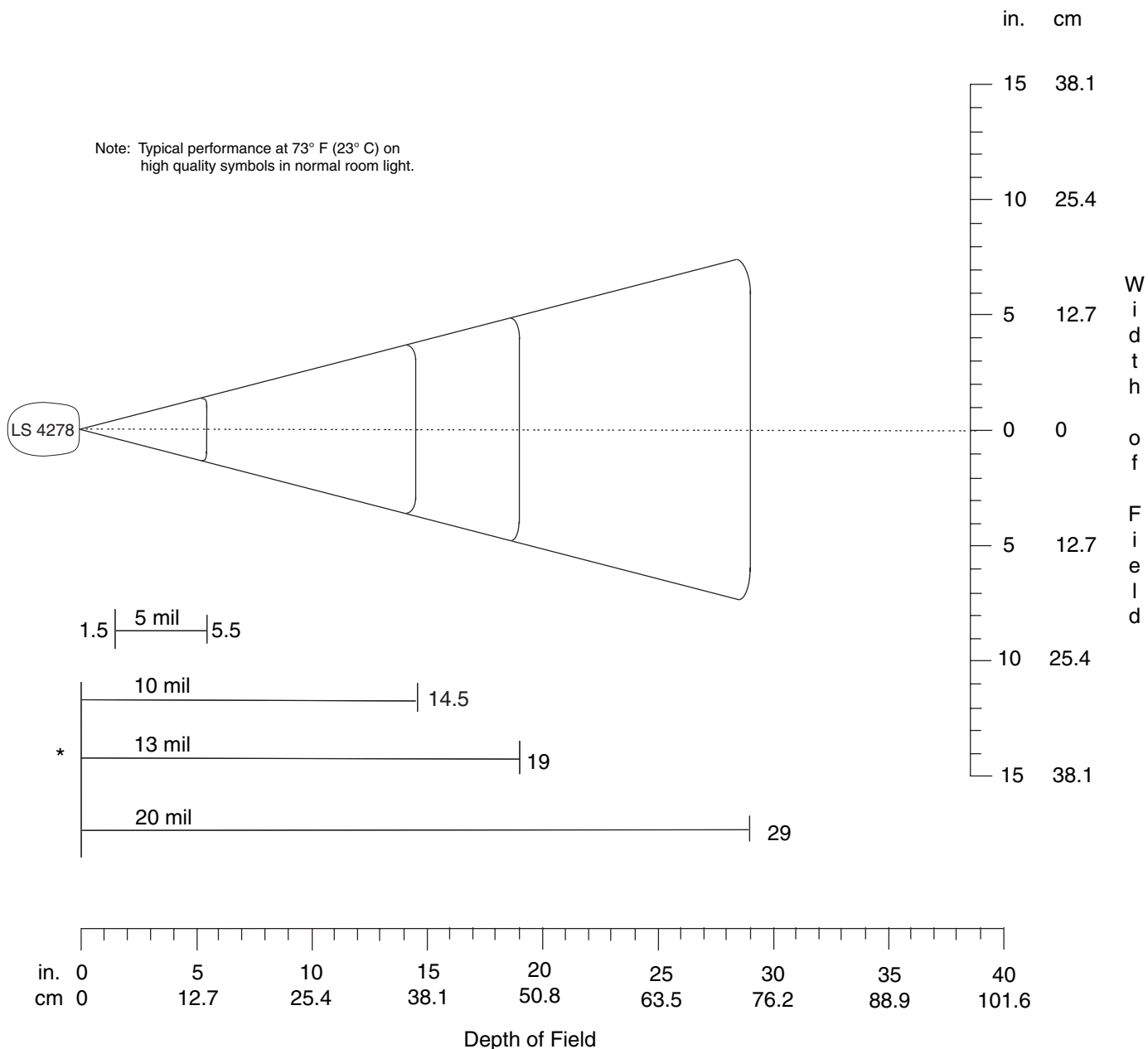

*Minimum distance determined by symbol length and scan angle

Figure 2-7. LS4278 Decode Zone

3

Maintenance, Troubleshooting & Technical Specifications

Introduction	3-3
Maintenance	3-3
Scanner	3-3
Cradle	3-3
Troubleshooting	3-4
Technical Specifications	3-7
Cradle Signal Descriptions	3-10

Introduction

This chapter provides suggested scanner and cradle maintenance, troubleshooting, technical specifications, and signal descriptions (pinouts).

Maintenance

Scanner

Cleaning the exit window is the only maintenance required. A dirty window may affect scanning accuracy.

- Do not allow any abrasive material to touch the window.
- Remove any dirt particles with a damp cloth.
- Wipe the window using a tissue moistened with ammonia/water.
- Do not spray water or other cleaning liquids directly into the window.

Cradle

- Do not pour, spray, or spill any liquid on the cradle.

Troubleshooting

Table 3-1. Troubleshooting

Problem	Possible Causes	Possible Solutions
Beeper Indications		
Scanner emits low/high/low beeps.	ADF transmit error.	Refer to the Advanced Data Formatting Programmer's Guide, p/n 72-69680-xx, for information about ADF programming.
	Invalid ADF rule is detected.	Refer to the Advanced Data Formatting Programmer's Guide, p/n 72-69680-xx, for information about ADF programming.
	The Code 39 buffer was erased or there was an attempt to clear or transmit an empty buffer.	Normal when scanning the Code 39 Buffering Clear Buffer bar code or upon attempt to transmit an empty Code 39 buffer.
Scanner emits a low/high/low/high beep sequence while it is being programmed.	Out of ADF parameter storage space.	Erase all rules and re-program with shorter rules.
Scanner emits long low/long high beeps.	Input error, incorrect bar code or Cancel bar code was scanned.	Scan the correct numeric bar codes within range for the parameter programmed.
	Page timeout; remote device is out of range/not powered.	Move the scanner back into range of the remote device; try to re-connect; check remote device configuration.
Scanner emits long low/long high/long low/long high beeps.	Out of host parameter storage space.	Scan Default Parameters on page 5-5 .
	Out of memory for ADF rules.	Reduce the number of ADF rules or the number of steps in the ADF rules.
	Connection attempt was rejected by remote device.	Free up remote device resources.
Scanner emits high/high/high/low beeps.	RS-232 receive error.	Normal during host reset. Otherwise, set the scanner's RS-232 parity to match the host setting.
Scanner emits high/low beeps.	The scanner is buffering Code 39 data. Or Keyboard parameter selected.	Normal. Or Enter value using bar code keypad.
	Bluetooth disconnection event.	Move the scanner back into range of the remote device. In Master (SPP/HID) mode, re-pair the scanner and cradle by scanning the PAIR bar code on the cradle; check cradle power. In Slave (SPP/HID) mode, reestablish connection between the scanner and remote device from the remote device side.
Scanner emits three long high beeps.	Code 39 buffer is full.	Scan the Code 39 bar code without a leading space or scan Do Not Buffer Code 39 on page 13-26 to transmit stored Code 29 data.
Scanner emits four high beeps on trigger release.	Low battery.	Place scanner in cradle to charge the battery.

Table 3-1. Troubleshooting (Continued)

Problem	Possible Causes	Possible Solutions
Scanner emits four long low beeps.	A transmission error was detected in a scanned symbol. The data is ignored.	This occurs if a unit is not properly configured. Check option setting.
	The scanner is either: - Out of range - Not paired to the cradle - Not connected to a remote Bluetooth device.	Move the scanner back into range of the remote device. Or Scan the PAIR bar code on the cradle.
	Acknowledgment that transmitted data was not received by the cradle.	Data may have been received by the host. Check the host system for receipt of transmitted data. If data was not received by the host, re-scan the bar code.
Scanner emits five low long beeps.	Conversion or format error.	Check ADF rules for the host.
Decoding Bar Codes		
Scanner emits the laser, but does not decode the bar code.	Scanner is not programmed for the correct bar code type.	Program the scanner to read that type of bar code. See Chapter 13, Symbologies .
	Bar code symbol is unreadable.	Scan test symbols of the same bar code type to determine if the bar code is defaced.
	Distance between scanner and bar code is incorrect.	Move the scanner closer to or further from the bar code. See Decode Zone on page 2-11 .
	The scan line is not crossing every bar and space of the symbol.	Move the symbol until the scan line is within the acceptable aiming pattern. See Figure 2-2 on page 2-6 .
Scanner decodes bar code, but does not transmit the data to the host.	Scanner is not programmed for the correct host type.	Scan the appropriate host type programming bar code. See the chapter corresponding to the host type.
	Interface cable is loose.	Ensure all cable connections are secure.
	Cradle is not programmed for the correct host interface.	Check scanner host parameters or edit options.
	Scanner not paired to host-connected interface.	Pair the scanner to the cradle by scanning the PAIR bar code on the cradle.
	Cradle has lost connection to host.	<i>In this exact order:</i> disconnect power supply; disconnect host cable; wait three seconds; reconnect host cable; reconnect power supply; reestablish pairing.
Scanner emits five long low beep after a bar code is decoded.	Conversion or format error was detected. The scanner's conversion parameters are not properly configured.	Ensure the scanner's conversion parameters are properly configured.
	Conversion or format error was detected. An ADF rule was set up with characters that can't be sent for the host selected.	Change the ADF rule, or change to a host that can support the ADF rule.
	Conversion or format error was detected. A bar code was scanned with characters that can't be sent for that host.	Change the bar code, or change to a host that can support the bar code.

Table 3-1. Troubleshooting (Continued)

Problem	Possible Causes	Possible Solutions
Host Displays		
Host displays scanned data incorrectly.	Scanner is not programmed to work with the host.	Ensure the proper host is selected. Scan the appropriate host type programming bar code.
		For RS-232, ensure the scanner's communication parameters match the host's settings.
		For a USB HID keyboard or Keyboard Wedge configuration, ensure the system is programmed for the correct keyboard type and language, and turn off the CAPS LOCK key.
		Ensure editing options (e.g., ADF, UPC-E to UPC-A Conversion) are properly programmed.
		Check the scanner's host type parameters or editing options.
Trigger		
Nothing happens when the trigger is pulled.	No power to the scanner.	Check the system power. If the configuration requires a power supply, re-connect the power supply. Check the battery. Ensure that end cap to battery chamber is secured.
	Interface/power cables are loose.	Check for loose cable connections and re-connect cables.
	Scanner is disabled.	For Synapse or IBM-468x mode, enable the scanner via the host interface.
The laser does not appear when the trigger is pulled.	No power to the scanner.	Check the system power. If the configuration requires a power supply, re-connect the power supply.
	Incorrect host interface cable is used.	Verify that the correct host interface cable is used. If not, connect the correct host interface cable.
	Interface/power cables are loose.	Check for loose cable connections and re-connect cables.



If after performing these checks the symbol still does not scan, contact the distributor or call the local Symbol Support Center. See [page xvi](#) for the telephone numbers.

Technical Specifications

Table 3-2. Technical Specifications - LS4278 Scanner

Item	Description
Physical Characteristics	
Dimensions	7.3 in. H x 3.85 in. L x 2.7 in. W (18.5 cm H x 9.7 cm L x 6.9 cm W)
Weight (with battery)	Approximately 8.4 oz. (238 g)
Color	Cash Register White or Twilight Black
Performance Characteristics	
Light Source (Laser)	650nm laser diode
Scan Element Frequency	50Hz
Decode Rate	200 decodes per second
Radio Range	Minimum 33 ft (10m) / Typical warehouse environment 50 ft. (15m)
Battery Specifications	720maH NiMH - (3) AAA number of scans per full charge: 32,000+ @ 1 scan/second Charge Time: Fully discharged battery: < 3 hours via external power / approximately 4.5 hours via host power through cable Note: Typical daily scans are less than 4,000, which fully charges within 1 hour
Roll Tolerance	± 35°
Pitch Tolerance	± 60°
Yaw Tolerance	± 60°
Nominal Working Distance	5 mil (Code 39): 1.5 to 5.5 in. (3.81 to 13.97 cm) 13 mil (100% UPC/EAN): 0 to 19 in. (0 to 48.25 cm) 10 mil (Code 39): 0 to 14 in. (0 to 35.56 cm) 20 mil (Code 39): 0 to 29 in. (0 to 73.66 cm) (See Decode Zone on page 2-11)
Print Contrast Minimum	25% minimum reflectance
Multi-Line Aiming Coverage	At 5 in. reading distance: ~ 0.5 in. (1.3 cm) At 10 in. reading distance: ~ 1 in. (2.5 cm)
Motion Tolerances	Horizontal Velocity: 200 in. (508 cm) / sec Vertical Velocity: 200 in. (508 cm) / sec Angular Velocity: 200 in. (508 cm) / sec
Decode Capability	UPC/EAN and with supplementals, Code 39, Code 39 Full ASCII, Tri-optic Code 39, RSS Variants, UCC/EAN 128, Code 128, Code 128 Full ASCII, Code 93, Codabar (NW1), Interleaved 2 of 5, Discrete 2 of 5 MSI, Codell, IATA, Bookland EAN, Code 32
Interfaces Supported	See Table 3-3 .
User Environment	
Operating Temperature	32° to 122° F (0° to 50° C)
Storage Temperature	-40° to 158° F (-40° to 70° C)

Table 3-2. Technical Specifications - LS4278 Scanner (Continued)

Item	Description
Humidity	5% to 95%, non-condensing
Drop Specifications	Withstands multiple 5 ft./1.5 m drops to concrete
# of Cradle Insertions	250,000+ insertions
Ambient Light Immunity	Immune to normal artificial indoor and natural outdoor (direct sunlight) lighting conditions
Regulatory	
Electrical Safety	UL1950, CSA C22.2 No. 950, EN60950/IEC950
Laser Safety	CDRH Class II, IEC Class 2
EMI/RFI	FCC Part 15 Class B, ICES-003 Class B, European Union EMC Directive, Australian SMA
Radio	Bluetooth, Class 2, Version 1.2, Serial Port & HID Profiles 2.402 to 2.480 GHz Adaptive Frequency Hopping (co-existence with 802.11 wireless networks) Data rate: 720 kbps
Accessories	
Mounting Options	Intellistand with adjustable height: 5-10 in. (12.7 cm -25.4 cm) Adjustable angle: 0° - 90° A desktop / wall-mount bracket is also available.
Lanyard	Lanyard attaches to the battery door.

Table 3-3. Technical Specifications - STB4208/4278 Cradle

Item	Description										
Physical Characteristics											
Dimensions:	2.0 in. H x 8.35 in. L x 3.4 in. W (5 cm H x 21.1 cm L x 8.6 cm W)										
Weight	Approximately 6.4 oz. (183 gm)										
Voltage & Current	Charging Cradle: <table border="0"> <tr> <td>Voltage</td> <td>Current</td> </tr> <tr> <td>5 +/-10% VDC</td> <td>620 mA (External power)</td> </tr> <tr> <td>5 +/-10% VDC</td> <td>450 mA (Host power through cable)</td> </tr> <tr> <td>12 +/-10% VDC</td> <td>270 mA (External power)</td> </tr> <tr> <td>12 +/-10% VDC</td> <td>230 mA (Host power through cable)</td> </tr> </table> Non-charging Cradle: 5V @ 70ma or 12 V @ 50 mA	Voltage	Current	5 +/-10% VDC	620 mA (External power)	5 +/-10% VDC	450 mA (Host power through cable)	12 +/-10% VDC	270 mA (External power)	12 +/-10% VDC	230 mA (Host power through cable)
Voltage	Current										
5 +/-10% VDC	620 mA (External power)										
5 +/-10% VDC	450 mA (Host power through cable)										
12 +/-10% VDC	270 mA (External power)										
12 +/-10% VDC	230 mA (Host power through cable)										
Color	Cash Register White or Twilight Black										
Power Requirements	4.75 - 14.0 VDC										

Table 3-3. Technical Specifications - STB4208/4278 Cradle (Continued)

Item	Description
Performance Characteristics	
Interfaces Supported	<p>Features on-board Multiple Interface with: RS-232C (Standard, Nixdorf, ICL, & Fujitsu); IBM 468x/469x; Keyboard Wedge; USB (Standard, IBM SurePOS, Macintosh); Laser/Wand Emulation; 123Scan; Remote Scanner Management.</p> <p>In addition, Synapse Adaptive Connectivity allows for connectivity to all of the above plus many non-standard interfaces.</p>
User Environment	
Operating Temperature	32° to 122° F (0° to 50° C)
Storage Temperature	-40° to 158° F (-40° to 70° C)
Charging Temperature	32° to 104° F (0° to 40° C) nominal, 41° to 95° F (5° to 35° C) ideal
Humidity	5% to 95% (non-condensing)
Regulatory	
Electrical Safety	UL1950, CSA C22.2 No. 950, EN60950/IEC950
EMI/RFI	FCC Part 15 Class B, ICES-003 Class B, European Union EMC Directive, Australian SMA
Radio	<p>Bluetooth, Class 2, Version 1.2, Serial Port & HID Profiles</p> <p>2.402 to 2.480 GHz Adaptive Frequency Hopping (co-existence with 802.11 wireless networks)</p> <p>Data rate: 720 kbps</p>
Accessories	
Mounting Options	Desktop / wall-mount bracket is available
Power Supplies	Power supplies are available for applications that do not supply power over the host cable.

Cradle Signal Descriptions

The signal descriptions in [Table 3-4](#) apply to the connector on the scanner and are for reference only.

Table 3-4. Cradle Signal Pin-outs

Pin	IBM	Synapse	RS-232	Keyboard Wedge	Wand	USB
1	Reserved	SynClock	Reserved	Reserved	Reserved	Jump to Pin 6
2	Power	Power	Power	Power	Power	Power
3	Ground	Ground	Ground	Ground	Ground	Ground
4	IBM_A(+)	Reserved	TxD	KeyClock	DBP	Reserved
5	Reserved	Reserved	RxD	TermData	CTS	D +
6	IBM_B(-)	SynData	RTS	KeyData	RTS	Jump to Pin 1
7	Reserved	Reserved	CTS	TermClock	Reserved	D -
8	Reserved	Reserved	Reserved	Reserved	Reserved	Reserved
9	N/A	N/A	N/A	N/A	N/A	N/A
10	N/A	N/A	N/A	N/A	N/A	N/A

[Figure 3-1](#) illustrates the positions of the cradle pins.

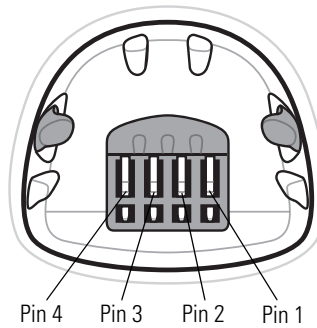

Figure 3-1. Cradle Pin Assignments

The signal descriptions in [Table 3-5](#) apply to the connector from the scanner to the scanner cradle and are for reference only.

Table 3-5. Cradle Pin-outs

Pin	Description
1	CRADLE_TXD
2	VCC
3	GND
4	CRADLE_RXD

4

Radio Communications

Introduction	4-3
Scanning Sequence Examples	4-3
Errors While Scanning	4-3
Radio Communications Parameter Defaults	4-4
Wireless Beeper Definitions	4-5
Radio Communications Host Types	4-6
HID Host Parameters	4-8
HID Country Keyboard Types (Country Codes)	4-8
HID Keyboard Keystroke Delay	4-10
HID CAPS Lock Override	4-10
HID Ignore Unknown Characters	4-11
Emulate Keypad	4-11
HID Keyboard FN1 Substitution	4-12
HID Function Key Mapping	4-12
Simulated Caps Lock	4-13
Convert Case	4-13
Auto-reconnect Feature	4-14
Scanner(s) To Cradle Support	4-15
Modes of Operation	4-15
Point-to-Point Communication	4-15
Multipoint-to-Point Communication	4-15
Pairing	4-16
Pairing Modes	4-16
Lock Override	4-17

Pairing Methods	4-17
Unpairing	4-18
Connection Maintenance Interval	4-18
Considerations	4-18
Bluetooth Technology Profile Support	4-21
Master/Slave Set Up	4-21
Master	4-21
Slave	4-21
Pairing Bar Code Format	4-21
Bluetooth Security	4-22
Authentication	4-22
PIN Code	4-22
Encryption	4-23

Introduction

This chapter provides information about the modes of operation and features available for wireless communication between scanners, cradles and hosts. The chapter also includes the parameters necessary to configure the scanner.

The scanner ships with the settings shown in the [Radio Communication Default Table on page 4-14](#) (also see [Appendix A, Standard Default Parameters](#) for all host device and miscellaneous scanner defaults). If the default values suit requirements, programming is not necessary.

To set feature values, scan a single bar code or a short bar code sequence. The settings are stored in non-volatile memory and are preserved even when the scanner is powered down.

If not using a Synapse or USB cable with the cradle, select a host type (see each host chapter for specific host information) after the power-up beeps sound. This is only necessary upon the first power-up when connected to a new host.

To return all features to default values, scan a default bar code in [Default Parameters on page 5-5](#). Throughout the programming bar code menus, default values are indicated with asterisks (*).



* Indicates Default — * **Disable Pair on Contacts** — Feature/Option

Scanning Sequence Examples

In most cases, scan one bar code to set a specific parameter value.

Errors While Scanning

Unless otherwise specified, to correct an error during a scanning sequence, just re-scan the correct parameter.

Radio Communications Parameter Defaults

Table 4-1 lists the defaults for radio communication parameters. If you wish to change any option, scan the appropriate bar code(s) provided in the Radio Communications Parameters section beginning on page 4-16.



See [Appendix A, Standard Default Parameters](#) for all user preferences, hosts, symbologies, and miscellaneous default parameters.

Table 4-1. Radio Communication Default Table

Parameter	Default	Page Number
Bluetooth Host (Host Type)	Cradle Host	4-17
Country Keyboard Types (Country Code)	North American	4-18
HID Keyboard Keystroke Delay	No Delay (0 msec)	4-20
CAPS Lock Override	Disable	4-20
Ignore Unknown Characters	Enable	4-21
Emulate Keypad	Disable	4-21
Keyboard FN1 Substitution	Disable	4-22
Function Key Mapping	Disable	4-22
Convert Case	No Case Conversion	4-23
Simulated Caps Lock	Disable	4-23
Parameter Broadcast (Cradle Host Only)	Enable	4-26
Modes of Operation (Point-to-Point/Multipoint-to-Point)	Point-to-Point	4-25
Pairing Modes	Unlocked	4-27
Pairing on Contacts	Disable	4-27
Connection Maintenance Interval	15 min	4-29
Remote Address (All Bluetooth Host Modes)	No Address	4-30
Authentication	Disable	4-31
Encryption	Disable	4-32

Wireless Beeper Definitions

When the scanner scans the pairing bar code it issues various beep sequences indicating successful or unsuccessful operations. [Table 4-2](#) defines beep sequences that occur during pairing operations. (For additional beeper definitions, see [Beeper Definitions on page 2-3](#)).

Table 4-2. Wireless Beeper Definitions

Beeper Sequence	Indication
Four long low beeps	<ol style="list-style-type: none"> 1. A transmission error was detected in a scanned symbol. The data is ignored. This occurs if a unit is not properly configured. Check option setting. 2. When communicating with a cradle, the cradle acknowledges receipt of data. If the acknowledgment is not received, this transmission error beep sequence sounds. Data may still have been received by the host. Check the host system for receipt of transmitted data. If data was not received by the host, re-scan the bar code.
High/low/high/low beeps	Pairing bar code scanned.
Low/high beeps	Bluetooth connection established.
High/low beeps	Bluetooth disconnection event. Note: When connected to a remote device using SPP or HID, if a disconnect beep sequence sounds immediately after a bar code is scanned, check the host device for receipt of transmitted data. It is possible that an attempt was made to transmit the last bar code scanned after the connection was lost.
Long low/long high beeps	Page timeout; remote device is out of range/not powered.
Long low/long high/long low/long high beeps	Connection attempt was rejected by remote device. Note: In the case of Pairing Methods on page 4-27 , the cradle may already be connected to another scanner in single Point-to-Point locked mode, or the piconet may be full in Multipoint-to-Point mode. If Pair On Contacts is enabled and the scanner that is inserted is already connected to the cradle, no beeping occurs.

Radio Communications Host Types

To set up the scanner for communication with a cradle, or to use standard Bluetooth profiles, scan the appropriate host type bar code below.

- Cradle Host (default) - Select this host type for scanner(s) to cradle operation. The scanner must then be paired to the cradle and the cradle communicates directly to the host via the host interface cable connection.
- Serial Port Profile (Master) - Select this host type for Bluetooth Technology Profile Support (see [page 4-30](#)). The scanner connects to the PC/host via Bluetooth and performs like there's a serial connection. The scanner initiates the connection to the remote device and is the Master. Scan **Serial Port Profile (Master)**, then scan the **PAIR** bar code for the remote device. See [Pairing Bar Code Format on page 4-30](#) for information about creating a pairing bar code for a remote device.
- Serial Port Profile (Slave) - Select this host type for Bluetooth Technology Profile Support (see [page 4-30](#)). The scanner connects to the PC/host via Bluetooth and performs like there's a serial connection. The scanner accepts incoming connection requested from a remote device and is the Slave. Scan **Serial Port Profile (Slave)** and wait for the incoming connection.
- HID Profile (Master) - Select this host type for Bluetooth Technology Profile Support. (See [page 4-30](#) for Bluetooth Technology Profile Support and Master/Slave definitions.) The scanner connects to the PC/host via Bluetooth and performs like a keyboard. The scanner initiates the connection to the remote device and is the Master. Scan **HID Profile (Master)**, then scan the **PAIR** bar code for the remote device. See [Pairing Bar Code Format on page 4-30](#) for information about creating a pairing bar code for a remote device.
- HID Profile (Slave) - Select this host type for Bluetooth Technology Profile Support. (See [page 4-30](#) for Bluetooth Technology Profile Support and Master/Slave definitions.) The scanner connects to the PC/host via Bluetooth and performs like a keyboard. The scanner accepts incoming connection requested from a remote device and is the Slave. Scan **HID Profile (Slave)** and wait for the incoming connection.



1. The scanner supports keyboard emulation over the Bluetooth HID profile. For detailed information, and HID host parameters, see [HID Host Parameters on page 4-18](#).

2. When the scanner is paired to the cradle in SPP Master, HID Master or Cradle Host mode, the scanner automatically tries to reconnect to a remote device when a disconnection occurs that is due to the radio losing communication. For more information see [Auto-reconnect Feature on page 4-24](#).

Radio Communications Host Types (continued)



***Cradle Host**



Serial Port Profile (Master)



Serial Port Profile (Slave)



HID Profile (Master)



HID Profile (Slave)

HID Host Parameters

The scanner supports keyboard emulation over the Bluetooth HID profile. In this mode the scanner can interact with Bluetooth enabled hosts supporting the HID profile as a Bluetooth keyboard. Scanned data is transmitted to the host as keystrokes.

Following are the keyboard parameters supported by the HID host.

HID Country Keyboard Types (Country Codes)

Scan the bar code corresponding to the keyboard type.



***North American Standard Keyboards**



French Windows



German Windows



French Canadian Windows 98



Spanish Windows



Italian Windows

HID Country Keyboard Types (Country Codes - Continued)



Swedish Windows



UK English Windows



Japanese Windows



French Canadian Windows 2000/XP



Portuguese/Brazilian Windows

HID Keyboard Keystroke Delay

This parameter sets the delay, in milliseconds, between emulated keystrokes. Scan a bar code below to increase the delay when the HID host requires a slower transmission of data.



***No Delay (0 msec)**



Medium Delay (20 msec)



Long Delay (40 msec)

HID CAPS Lock Override

When enabled, the case of the data is preserved regardless of the state of the caps lock key. This setting is always enabled for the "Japanese, Windows (ASCII)" keyboard type and can not be disabled.



***Do Not Override Caps Lock Key
(Disable)**



**Override Caps Lock Key
(Enable)**

HID Ignore Unknown Characters

Unknown characters are characters the host does not recognize. When **Send Bar Codes With Unknown Characters** is scanned, all bar code data is sent except for unknown characters, and no error beeps sound. When **Do Not Send Bar Codes With Unknown Characters** is scanned, bar codes containing at least one unknown character are not sent to the host, and an error beep sounds.



***Send Bar Codes With Unknown Characters
(Enable)**



**Do Not Send Bar Codes With Unknown Characters
(Disable)**

Emulate Keypad

When enabled, all characters are sent as ASCII sequences over the numeric keypad. For example, ASCII A is sent as "ALT make" 0 6 5 "ALT Break."



***Disable Keypad Emulation**



Enable Keypad Emulation

HID Keyboard FN1 Substitution

When enabled, this parameter allows replacement of any FN1 character in an EAN128 bar code with a Key Category and value chosen by the user. See [FN1 Substitution Values on page 5-13](#) to set the Key Category and Key Value.



***Disable Keyboard FN1 Substitution**



Enable Keyboard FN1 Substitution

HID Function Key Mapping

ASCII values under 32 are normally sent as control-key sequences. When this parameter is enabled, the keys in bold are sent in place of the standard key mapping (see [Table 8-2 on page 8-140](#)). Table entries that do not have a bold entry remain the same whether or not this parameter is enabled.



***Disable Function Key Mapping**



Enable Function Key Mapping

Simulated Caps Lock

When enabled, the scanner inverts upper and lower case characters on the scanner bar code as if the Caps Lock state is enabled on the keyboard. This inversion is done regardless of the current state of the keyboard Caps Lock state.



***Disable Simulated Caps Lock**



Enable Simulated Caps Lock

Convert Case

When enabled, the scanner converts all bar code data to the selected case.



***No Case Conversion**



Convert All to Upper Case



Convert All to LowerCase

Auto-reconnect Feature

When in SPP Master, HID Master or Cradle Host mode, the scanner automatically tries to reconnect to a remote device when a disconnection occurs that is due to the radio losing communication. This can happen if the scanner goes out of range with the remote device, or if the remote device powers down. The scanner tries to reconnect for 30 seconds.

If the auto-reconnect process fails due to page time-outs, the scanner enters low power mode. The auto-reconnect process can be re-started by pulling the scanner trigger.

If the auto-reconnect process fails because the remote device rejects the connection attempt, the scanner sounds a connection reject beep sequence (see [Wireless Beeper Definitions on page 4-15](#)) and deletes the remote pairing address. If this happens, a pairing bar code must be scanned to attempt a new connection to the remote device.



Note

If a bar code is scanned while the auto-reconnect sequence is in process, a transmission error beep sequence sounds and the data is not transmitted to the host. After a connection is reestablished, normal scanning operation returns. For error beep sequence definitions, see [Beeper Definitions on page 2-3](#).

The scanner has memory available for storing a remote Bluetooth address for each Master mode (SPP, HID, Cradle). When switching between these modes, the scanner automatically tries to reconnect to the last device it was connected to in that mode.



Note

Switching between Bluetooth host types by scanning a host type bar code ([page 4-16](#)) causes the radio to be reset. Scanning is disabled during this time. It takes several seconds for the scanner to re-initialize the radio at which time scanning is enabled.

Scanner(s) To Cradle Support

Modes of Operation

The charging cradle with radio supports two radio communication modes of operation, allowing the scanner to communicate wirelessly:

- Point-to-Point
- Multipoint-to-Point.

Point-to-Point Communication

In Point-to-Point communication mode, the cradle allows one scanner to connect to it at a time. In this mode, the scanner is paired to the cradle either by insertion into the cradle (if pairing on contacts is enabled), or by scanning the **PAIR** bar code on the cradle. Communication can be locked, unlocked (default), or in a lock override state (see [Pairing Modes on page 4-26](#)). In locked mode, locking intervals must be set by scanning a connection maintenance interval bar code beginning on [page 4-28](#).

To activate this mode of operation, scan **Point-to-Point**.

Multipoint-to-Point Communication

In Multipoint-to-Point communication mode, up to three scanners can be paired to one cradle.

To activate this mode of operation, the **Multipoint-to-Point** bar code must be scanned by the first scanner connected to the cradle. This communication mode is always locked (see [Pairing Modes on page 4-26](#)). Locking intervals must be set by scanning a connection maintenance interval bar code beginning on [page 4-28](#). This mode allows a parameter broadcast ([page 4-26](#)) that clones all scanners paired to the cradle so only one scanner needs to be programmed.



The number of scanners is dependent on the host's capability.

To select Point-to-Point or Multipoint-to-Point mode, scan the appropriate bar code.



Multipoint-to-Point Mode



***Point-to-Point Mode**

Parameter Broadcast (Cradle Host Only)

When in multipoint-to-point mode, enable Parameter Broadcast to broadcast all parameter bar codes scanned to all other scanners in the piconet. If disabled, parameter bar codes are processed by the individual scanner only, and the scanner ignores parameters broadcast from other scanners or from the cradle.



***Enable Parameter Broadcast**



Disable Parameter Broadcast

Pairing

Pairing is the process by which a scanner initiates communication with a cradle. If the **Multipoint-to-Point** is scanned, multi scanner to cradle operation is activated and up to three scanners can be paired to one cradle. The cradle includes a pairing bar code.

To pair the scanner with the cradle, scan the pairing bar code on the cradle. A high/low/high/low beep sequence indicates that the pairing bar code was decoded. When a connection between the cradle and scanner is established, a low/high beep sounds.



1. The pairing bar code that connects the scanner to a cradle is unique to each cradle.
2. Do not scan data or parameters until pairing completes.
3. When the scanner is paired to the cradle in SPP Master, HID Master or Cradle Host mode, the scanner automatically tries to reconnect to a remote device when a disconnection occurs that is due to the radio losing communication. For more information see [Auto-reconnect Feature on page 4-24](#).

Pairing Modes

When operating with the cradle, two modes of pairing are supported:

- Locked Pairing Mode - When a cradle is paired (connected) to the scanner any attempt to connect a different scanner, by either scanning the **PAIR** bar code on the cradle or by inserting it into the cradle with the pairing on contacts feature enabled, is rejected. The currently connected scanner maintains its connection. In this mode, connection maintenance interval must be set.
- Unlocked Pairing Mode (Point-to-Point only) - A new scanner can be paired (connected) to a cradle at any time by either scanning the **PAIR** bar code on the cradle or by inserting it into the cradle with the pairing on contacts feature enabled. The original scanner is disconnected from the cradle in favor of the new one.
- Lock Override (Point-to-Point only) - Overrides a locked scanner base pairing to connect a new scanner (see [page 4-27](#)).



In Multipoint-to-Point mode, when the piconet is full (three scanners connected to the cradle), one of the connected scanners must be disconnected by scanning **Unpair** ([page 4-28](#)), before a new scanner can join the piconet.

To set the cradle pairing mode, scan the appropriate bar code below.



***Unlocked Pairing Mode**



Locked Pairing Mode

Lock Override

In Point-to-Point mode, scan **Lock Override** when, in some circumstances, it may be necessary to override a locked scanner base pairing and connect a new scanner. Scan **Lock Override** followed by the pairing bar code on the cradle.



LockOverride

Pairing Methods

There are two pairing methods. The default method allows the scanner and cradle to pair (connect) when the pairing bar code on the cradle is scanned. A second method pairs the scanner and cradle when the scanner is inserted in the cradle. To enable this feature, scan **Enable Pair On Contacts** below. With this feature enabled it is not necessary to scan the pairing bar code on the cradle. If the pairing is successful, a low/high connection beep sequence sounds a few seconds after the scanner is placed in the cradle. See [Wireless Beeper Definitions on page 4-15](#) for other beep sequences.

To enable or disable pairing on contacts, scan the appropriate bar code below.



Enable Pair On Contacts



***Disable Pair on Contacts**

Unpairing

Unpair the scanner from the cradle or PC/host to make the cradle available for pairing with another scanner. Scan the bar code below to disconnect the scanner from its cradle/PC host.

An unpairing bar code is also included in the *LS4278 Quick Reference Guide*.

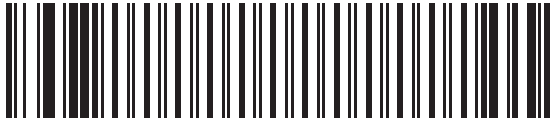

Unpairing

Connection Maintenance Interval



The Connection Maintenance Interval only applies in locked pairing mode (see [4-26](#)).

When a scanner disconnects from a cradle due to a Link Supervision Timeout, the scanner immediately attempts to reconnect to the cradle for 30 seconds. If the auto-reconnect process fails, it can be restarted by pulling the scanner trigger.

To guarantee that a disconnected scanner can reconnect when it comes back in range, the cradle reserves the connection for that scanner for a period of time defined by the Connection Maintenance Interval. If the cradle is supporting the maximum three scanners and one scanner disconnects, a fourth scanner cannot pair to the cradle during this interval. To connect another scanner: either wait until the connection maintenance interval expires then scan the **PAIR** bar code on the cradle with the new scanner; or, scan **Lock Override** ([page 4-27](#)) with the new scanner then scan the **PAIR** bar code on the cradle.



When the cradle supports the maximum three scanners, it stores the remote pairing address of each scanner in memory regardless of the scanner condition (e.g., discharged battery). When you want to change the scanners paired to the cradle, unpair each scanner currently connected to the cradle by scanning the **Unpairing** bar code prior and reconnect each appropriate scanner by scanning the **PAIR** bar code on the cradle.

Connection Maintenance Interval options are:

- 15 minutes
- 30 minutes
- One hour
- Two hours
- Four hours
- Eight hours
- 24 hours
- Indefinitely.

Considerations

The system administrator determines the Connection Maintenance Interval. A shorter interval allows new users to gain access to abandoned connections more quickly, but causes problems if users leave the work area for extended periods. A longer interval allows existing users to leave the work area for longer periods of time, but ties up the system for new users.

To avoid this conflict, users who are going off-shift can scan the unpair bar code on [page 4-28](#) to ignore the Connection Maintenance Interval and make the connection immediately available.

To set the Connection Maintenance Interval, scan one of the bar codes below



***Set Interval to 15 Minutes**



Set Interval to 30 Minutes



Set Interval to 60 Minutes



Set Interval to 2 Hours



Set Interval to 4 Hours



Set Interval to 8 Hours



Set Interval to 24 Hours



Set Interval to Forever

Bluetooth Technology Profile Support

With Bluetooth Technology Profile Support, the cradle is not required for wireless communication. The scanner communicates directly to the host using Bluetooth technology. The scanner supports the standard Bluetooth Serial Port Profile (SPP) and HID Profiles which enable the scanner to communicate with other Bluetooth devices that support these profiles.

- SPP - the scanner connects to the PC/host via Bluetooth and performs like there's a serial connection.
- HID - the scanner connects to the PC/host via Bluetooth and performs like a keyboard.

Master/Slave Set Up

The scanner can be set up as a Master or Slave.

When the scanner is set up as a Slave, it is discoverable and connectable to other devices. When the scanner is set up as a Master, the Bluetooth address of the remote device to which a connection is requested is required. A pairing bar code with the remote device address must be created and scanned to attempt a connection to the remote device. See the [Pairing Bar Code Format on page 4-30](#) for information about creating a pairing bar code.

Master

When the scanner is set up as a Master (SPP or HID), it initiates the radio connection to a slave device. Initiating the connection is done by scanning a pairing bar code for the remote device (see [Pairing Bar Code Format on page 4-30](#)).

Slave

When the scanner is set up as a Slave device (SPP or HID), the scanner accepts an incoming connection request from a remote device.



The number of scanners is dependent on the host's capability.

Pairing Bar Code Format

When the scanner is configured as an SPP or HID Master, a pairing bar code must be created for the remote Bluetooth device to which the scanner can connect. The Bluetooth address of the remote device must be known. Pairing bar codes are Code 128 bar codes and are formatted as follows:

<Fnc 3>Bxxxxxxxxxxx

where xxxxxxxxxxxx represents the 12-character Bluetooth address.

Pairing Bar Code Example

If the remote device to which the scanner can connect has a Bluetooth address of 11:22:33:44:55:66, then the pairing bar code is:



Bluetooth Security

The scanner supports Bluetooth Authentication and Encryption. Authentication can be requested by either the remote device or the scanner. When Authentication is requested, the scanner uses its programmed PIN code to generate a link key. Once Authentication is complete, either device may then negotiate to enable Encryption.



A remote device can still request Authentication.

Authentication

To force Authentication with a remote device (including the cradle), scan the **Enable Authentication** bar code below. To prevent the scanner from forcing Authentication, scan the **Disable Authentication** bar code below.



Enable Authentication



***Disable Authentication**

PIN Code

To set the PIN code (e.g., password) on the scanner, scan the bar code below followed by five alphanumeric programming bar codes (see [Appendix E, Alphanumeric Bar Codes](#). The default PIN code is "12345."

If the scanner communicates with a cradle with security enabled, the PIN codes on the scanner and cradle should be synchronized. To achieve this, the scanner must be connected to the cradle when setting the PIN codes. If the scanner is not connected to a cradle, the PIN code change only takes affect on the scanner. If security is required between the scanner and cradle, and the PIN codes do not match, pairing will fail. If the PIN codes are out of synch, re-synchronize them by disabling security, establish a connection to the cradle, and then program a new PIN code.



Set PIN Code

Encryption



Authentication must be performed before Encryption can take effect.

To set up the scanner for enabling Encryption, scan **Enable Encryption**. To prevent the scanner from enabling Encryption, scan **Disable Encryption**. When enabled, the radio encrypts data.



Enable Encryption



*** Disable Encryption**

5

User Preferences

Introduction	5-3
Scanning Sequence Examples	5-3
Errors While Scanning	5-3
User Preferences Parameter Defaults	5-4
User Preferences	5-5
Default Parameters	5-5
Beeper Tone	5-6
Beeper Volume	5-6
Power Mode	5-7
Time Delay to Reduced Power Mode	5-7
Scan Pattern	5-8
Scan Line Width	5-9
Laser On Time	5-9
Beep After Good Decode	5-10
Transmit Code ID Character	5-10
Prefix/Suffix Values	5-11
Scan Data Transmission Format	5-11
FN1 Substitution Values	5-13
Transmit "No Read" Message	5-13
Synapse Interface	5-14
Batch Mode	5-15
Modes of Operation	5-15

Introduction

If desired, program the scanner to perform various functions, or activate different features. This chapter describes each user preference feature and provides the programming bar codes necessary for selecting these features.

The scanner ships with the settings shown in the [User Preferences Default Table on page 5-4](#) (also see [Appendix A, Standard Default Parameters](#) for all host device and miscellaneous defaults). If the default values suit requirements, programming may not be necessary.

To set feature values, scan a single bar code or a short bar code sequence. The settings are stored in non-volatile memory and are preserved even when the scanner is powered down.

If not using a Synapse or USB cable, select a host type (see each host chapter for specific host information) after the power-up beeps sound. This is only necessary upon the first power-up when connected to a new host.

To return all features to their default values, see [Default Parameters on page 5-5](#). Throughout the programming bar code menus, default values are indicated with asterisks (*).



* Indicates Default *High Frequency Feature/Option

Scanning Sequence Examples

In most cases, scanning one bar code sets the parameter value. For example, to set the beeper tone to high, scan the **High Frequency** (beeper tone) bar code listed under [Beeper Tone on page 5-6](#). The scanner issues a fast warble beep and the LED turns green, signifying a successful parameter entry.

Other parameters, such as **Serial Response Time-Out** or **Data Transmission Formats**, require scanning several bar codes. See these parameter descriptions for this procedure.

Errors While Scanning

Unless otherwise specified, when an error is made during a scanning sequence, just re-scan the correct parameter.

User Preferences Parameter Defaults

Table 5-1 lists the defaults for user preferences parameters. To change any option, scan the appropriate bar code(s) provided in the User Preferences section beginning on page 5-5.



See [Appendix A, Standard Default Parameters](#) for all user preferences, hosts, symbologies, and miscellaneous default parameters.

Table 5-1. User Preferences Default Table

Parameter	Default	Page Number
User Preferences		
Beeper Tone	Medium	5-6
Beeper Volume	High	5-6
Power Mode	Reduced Power Mode	5-7
Time Delay to Reduced Power Mode	1 sec	5-7
Scan Pattern	Multi-line Always Raster	5-8
Scan Line Width	Full Width	5-9
Laser On Time	3.0 sec	5-9
Beep After Good Decode	Enable	5-10
Transmit Code ID Character	None	5-10
Prefix Value	7013 <CR><LF>	5-11
Suffix Value	7013 <CR><LF>	5-11
Scan Data Transmission Format	Data as is	5-12
FN1 Substitution Values	Set	5-13
Transmit "No Read" Message	Disable	5-13
Synapse Interface	Standard	5-14
Transmit Code ID Character	None	5-10
Batch Mode	Normal (Do Not Batch Data)	5-16

User Preferences

Default Parameters

The scanner can be reset to two types of defaults: factory defaults or custom defaults. Scan the appropriate bar code below to reset the scanner to its default settings and/or set the scanner's current settings as the custom default.

- **Restore Defaults** - Resets all default parameters as follows:
 - If custom default values were configured (see **Write to Custom Defaults**), the custom default values are set for all parameters each time the **Restore Defaults** bar code below is scanned.
 - If no custom default values were configured, the factory default values are set for all parameters each time the **Restore Defaults** bar code below is scanned. (For factory default values, see [Table A-1](#) beginning on [page A-1.](#))
- **Set Factory Defaults** - Scan the **Set Factory Defaults** bar code below to eliminate all custom default values and set the scanner to factory default values. (For factory default values, see [Table A-1](#) beginning on [page A-1.](#))
- **Write to Custom Defaults** - Custom default parameters can be configured to set unique default values for all parameters. After changing all parameters to the desired default values, scan the **Write to Custom Defaults** bar code below to configure custom defaults.



*Restore Defaults



Set Factory Defaults



Write to Custom Defaults

Beeper Tone

To select a decode beep frequency (tone), scan the **Low Frequency**, **Medium Frequency**, or **High Frequency** bar code.

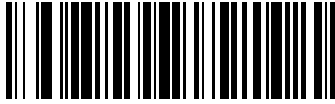

Low Frequency



***Medium Frequency
(Optimum Settings)**

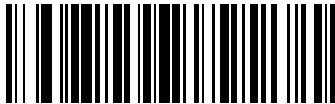

High Frequency

Beeper Volume

To select a beeper volume, scan the **Low Volume**, **Medium Volume**, or **High Volume** bar code.



Low Volume



Medium Volume



***High Volume**

Power Mode

This parameter determines whether or not power remains on after a decode attempt. When in reduced power mode, the scanner enters into a low power consumption mode to preserve battery life after each decode attempt. When in continuous power mode, power remains on after each decode attempt.



Continuous On



***Reduced Power Mode**

Time Delay to Reduced Power Mode

This parameter sets the time it takes the scanner to enter reduced power mode after any scanning activity. Scan the appropriate bar code below to set the time.



***1 sec**



2 secs



3 secs

Time Delay to Reduced Power Mode (continued)



4 secs



5 secs

Scan Pattern

This parameter determines the pattern (mode) of scanning. Scan the appropriate bar code below to set the scanning mode.

- **Single-line Only** - Scan **Single-line Only** for a single-line scan mode. The laser has no up and down scan line movement (no raster). (For an example of a single-line scan, see [Figure 2-2 on page 2-6.](#))
- **Multi-line Smart Raster** - Scan **Multi-line Smart Raster** for a scan line begins as a single line and moves up and down (rasters) when a partial scan of a bar code is detected, or no bar code is decoded 500 ms after the trigger is pulled. Upon seeing a stacked RSS code, the scanner immediately rasters. (For an example of a multi-line scan, see [Figure 2-3 on page 2-6.](#))
- **Multi-line Always Raster** (default) - Scan **Multi-line Always Raster** for rastering (up and down scan line movement) to begin immediately.

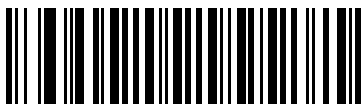

Single-line Only
(No Raster)

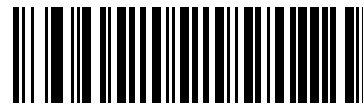

Multi-line Smart Raster

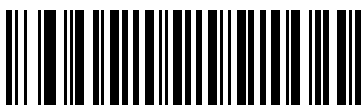

***Multi-line Always Raster**

Scan Line Width

Scan a bar code below to set the scan line width.



***Full Width**



Medium Width



Small Width

Laser On Time

This parameter sets the maximum time that decode processing continues during a scan attempt. It is programmable in 0.1 second increments from 0.5 to 9.9 seconds. The default Laser On Time is 3.0 seconds.

To set a Laser On Time, scan the bar code below. Next, scan two numeric bar codes beginning on page [D-1](#) in [Appendix D, Numeric Bar Codes](#) that correspond to the desired on time. Single digit numbers must have a leading zero. For example, to set an On Time of 0.5 seconds, scan the bar code below, then scan the "0" and "5" bar codes. If an error is made, or the selection needs to be changed, scan **Cancel** on page [D-4](#).



Laser On Time

Beep After Good Decode

Scan a bar code below to select whether or not the scanner beeps after a good decode. If **Do Not Beep After Good Decode** is selected, the beeper still operates during parameter menu scanning and indicates error conditions.



*** Beep After Good Decode
(Enable)**

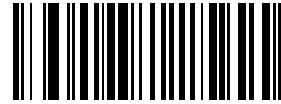

**Do Not Beep After Good Decode
(Disable)**

Transmit Code ID Character

A Code ID character identifies the code type of a scanned bar code. This may be useful when the scanner is decoding more than one code type. In addition to any single character prefix already selected, the Code ID character is inserted between the prefix and the decoded symbol.

Select no Code ID character, a Symbol Code ID character, or an AIM Code ID character. For Code ID Characters, see [Symbol Code Identifiers on page B-3](#) and [AIM Code Identifiers on page B-4](#).

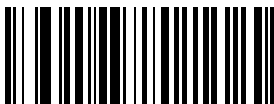

Symbol Code ID Character

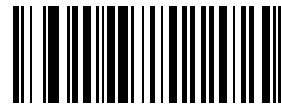

AIM Code ID Character

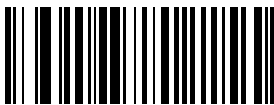

*** None**

Prefix/Suffix Values

A prefix and/or suffix can be appended to scan data for use in data editing.

To set a value for a prefix or suffix:

1. Change the scan data format by scanning the appropriate [Scan Data Transmission Format on page 5-11](#).
2. Scan the appropriate prefix/suffix bar code on [page 5-11](#).
3. Scan a four-digit number (i.e., four bar codes from [Appendix D, Numeric Bar Codes](#)) that corresponds to that value.



.When using host commands to set the prefix or suffix, set the key category parameter to 1, then set the 3-digit decimal value. See [Table F-1 on page F-1](#) for the four-digit codes.

4. To correct an error or change a selection, scan **Cancel** on [page D-4](#).



Scan Prefix



Scan Suffix

Scan Data Transmission Format

To change the scan data format, scan **Scan Options** and one of the following four bar codes corresponding to the desired format:

- **Data As Is**
- **<DATA> <SUFFIX>**
- **<PREFIX> <DATA>**
- **<PREFIX> <DATA> <SUFFIX>**.

Scan **Enter** on page [5-12](#) to complete the change. To set values for the prefix and/or suffix, see [Prefix/Suffix Values on page 5-11](#).

Scan **Data Format Cancel** on page [5-12](#) to cancel the change.

If a carriage return/enter is required after each scanned bar code, scan the following bar codes in order:

1. **Scan Options**
2. **<DATA> <SUFFIX>**
3. **Enter** (on page [5-12](#)).

Scan Data Transmission Format (continued)



Scan Options



*Data As Is

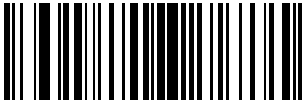

<DATA> <SUFFIX>



<PREFIX> <DATA>

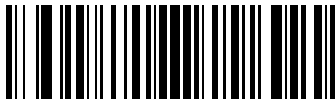

<PREFIX> <DATA> <SUFFIX>



Enter



Data Format Cancel

FN1 Substitution Values

The Wedge and USB HID Keyboard hosts support an FN1 substitution feature. When enabled any FN1 character (0x1b) in an EAN128 bar code is substituted with a value. This value defaults to 7013 (Enter Key).

To select an FN1 substitution value via bar code menus:

1. Scan the bar code below.

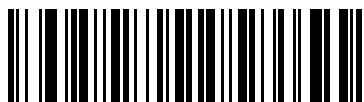

***Set FN1 Substitution Value**

2. Look up the keystroke desired for FN1 Substitution in the [ASCII Value Standard Default Parameters Table on page F-1](#) for the currently installed host interface.
3. Enter the 4-digit substitution value by scanning each digit in [Appendix D, Numeric Bar Codes](#).

To correct an error or change the selection, scan **Cancel**.

To enable FN1 substitution for keyboard wedge, scan the **Enable FN1 Substitution** bar code on page [page 6-12](#).

To enable FN1 Substitution for USB HID keyboard, scan the **Enable FN1 Substitution** bar code on page [page 8-11](#).

Transmit "No Read" Message

Scan a bar code below to select whether or not to transmit a No Read message. When enabled, the characters NR are transmitted when a bar code is not decoded. When disabled, if a symbol does not decode, nothing is sent to the host.



Enable No Read



***Disable No Read**

Synapse Interface

The auto-detection of a Synapse cable varies in duration depending on the type of Synapse connection. If a scanner is connected to another scanner using a Synapse cable, use the Auxiliary Synapse Port connection. In all other cases, where the cable is used, the default setting is recommended.

To disconnect and reconnect the scanner from a Synapse cable that is connected to a live host via a Synapse, use the "Plug and Play" setting. Do not change this setting from the default if an on-board wedge host is enabled.

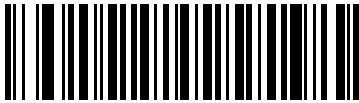

***Standard Synapse Connection**



Auxiliary Synapse Port Connection

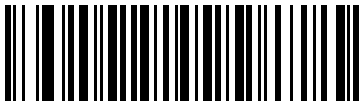

"Plug and Play" Synapse Connection

Batch Mode

The scanner supports three versions of batch mode. When the scanner is configured for any of the batch modes, it attempts to store bar code data (not parameter bar codes) until transmission is initialized, or the maximum number of bar codes are stored. When a bar code is saved successfully, a good decode beep sounds and the LED flashes green. If the scanner is unable to store a new bar code, a low/high/low/high out of memory beep sounds. (See pages 2-3, 2-4 and 4-15 for all beeper and LED definitions.)

Modes of Operation

- **Normal (default)** - Do not batch data. The scanner attempts to transmit every scanned bar code.
- **Out of Range Batch Mode** - The scanner starts storing bar code data when it loses its connection to a remote device (for example, when a user holding the scanner walks out of range). Data transmission is triggered by reestablishing the connection with the remote device (for example, when a user holding the scanner walks back into range).
- **Standard Batch Mode** - The scanner starts storing bar code data after **Enter Batch Mode** is scanned. Data transmission is triggered by scanning **Send Batch Data**.



Note

Transmission is halted if the connection to the remote device is lost.

- **Cradle Contact Batch Mode** - The scanner starts storing bar code data when **Enter Batch Mode** is scanned. Data transmission is triggered by insertion of the scanner into the cradle.



Note

If the scanner is removed from the cradle during batch data transfer, transmission halts until the scanner is re-inserted in the cradle.

In all modes, transmissions are halted if the scanner is moved out of range. The scanner resumes when it is back in range. If a bar code is scanned while batch data is transmitted it is appended to the end of the batched data; parameter bar codes are not stored.

Batch Mode (continued)



***Normal**



Out of Range Batch Mode



Standard Batch Mode



Cradle Contact Batch Mode



Enter Batch Mode



Send Batch Data

6

Keyboard Wedge Interface

Introduction	6-3
Connecting a Keyboard Wedge Interface	6-4
Keyboard Wedge Parameter Defaults	6-5
Keyboard Wedge Host Parameters	6-6
Keyboard Wedge Host Types	6-6
Keyboard Wedge Country Types (Country Codes)	6-7
Ignore Unknown Characters	6-8
Keystroke Delay	6-9
Intra-Keystroke Delay	6-9
Alternate Numeric Keypad Emulation	6-10
Caps Lock On	6-10
Caps Lock Override	6-10
Convert Wedge Data	6-11
Function Key Mapping	6-11
FN1 Substitution	6-12
Send Make and Break	6-12
Keyboard Maps	6-13
ASCII Character Set for Keyboard Wedge	6-14



Introduction

This chapter provides instructions for programming the cradle for keyboard wedge host interface, used to connect the cradle between the keyboard and host computer. The scanner translates the bar code data into keystrokes, and transmits the information to the host computer via the cradle interface. The host computer accepts the keystrokes as if they originated from the keyboard.

This interface adds bar code reading functionality to a system designed for manual keyboard input. In this mode the keyboard keystrokes are simply passed through.

Throughout the programming bar code menus, default values are indicated with asterisks (*).



* Indicates Default — ***North American** — Feature/Option

Connecting a Keyboard Wedge Interface

Note

See [Chapter 4, Radio Communications](#) for information about scanner/cradle pairing and wireless communication.

The scanner must be connected to the cradle for the host parameter setting to take effect. When the scanner is not connected to a cradle, and a host parameter bar code is scanned, a long low/long high beep sequence sounds.

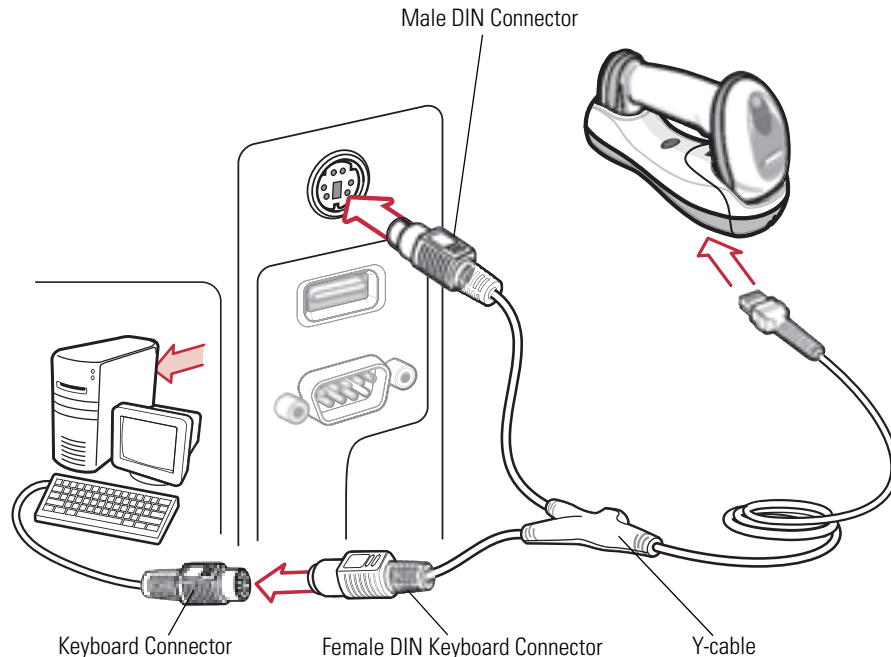

Figure 6-1. Keyboard Wedge Connection with Y-cable

To connect the Keyboard Wedge interface Y-cable:

1. Turn off the host and unplug the keyboard connector.
2. Attach the modular connector of the Y-cable to the host port on the bottom of the scanner cradle. See [Connecting the Cradle on page 1-8](#).
3. Connect the round male DIN host connector of the Y-cable to the keyboard port on the host device.
4. Connect the round female DIN keyboard connector of the Y-cable to the keyboard connector.
5. If needed, attach the optional power supply to the connector in the middle of the Y-cable.
6. Ensure that all connections are secure.
7. Turn on the host system.
8. Select the Keyboard Wedge host type by scanning the appropriate bar code from [Keyboard Wedge Host Parameters on page 6-6](#).
9. To modify any other parameter options, scan the appropriate bar codes in this chapter.

Note

Interface cables vary depending on configuration. The connectors illustrated in [Figure 6-1](#) are examples only. The connectors may be different than those illustrated, but the steps to connect the cradle remain the same.

If a power supply is used, disconnect the power supply before changing host cables or the cradle may not recognize the new host.



Keyboard Wedge Parameter Defaults

Table 6-1 lists the defaults for Keyboard Wedge host parameters. To change any option, scan the appropriate bar code(s) in the Keyboard Wedge Host Parameters section beginning on page [page 6-6](#).



See [Appendix A, Standard Default Parameters](#) for all user preferences, hosts, symbologies, and miscellaneous default parameters.

Table 6-1. Keyboard Wedge Host Default Table

Parameter	Default	Page Number
Keyboard Wedge Host Parameters		
Keyboard Wedge Host Type	IBM PC/AT& IBM PC Compatibles ¹	6-6
Country Types (Country Codes)	North American	6-7
Ignore Unknown Characters	Send	6-8
Keystroke Delay	No Delay	6-9
Intra-Keystroke Delay	Disable	6-9
Alternate Numeric Keypad Emulation	Disable	6-10
Caps Lock On	Disable	6-10
Caps Lock Override	Disable	6-10
Convert Wedge Data	No Convert	6-11
Function Key Mapping	Disable	6-11
FN1 Substitution	Disable	6-12
Send and Make Break	Send	6-12
¹ User selection is required to configure this interface and this is the most common selection.		

Keyboard Wedge Host Parameters

Keyboard Wedge Host Types

Select the Keyboard Wedge host by scanning one of the bar codes below.



IBM PC/AT & IBM PC Compatibles¹



IBM AT Notebook

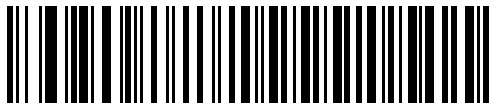

NCR 7052



¹User selection is required to configure this interface and this is the most common selection.



Keyboard Wedge Country Types (Country Codes)

Scan the bar code corresponding to the keyboard type. If the keyboard type is not listed, see [Alternate Numeric Keypad Emulation on page 6-10](#).

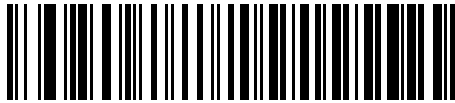

***North American**

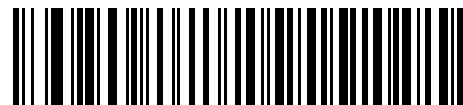

German Windows

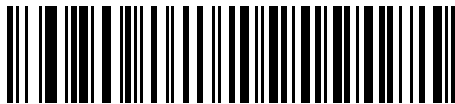

French Windows



French Canadian Windows 95/98

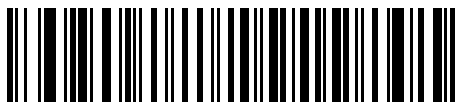

French Canadian Windows XP/2000

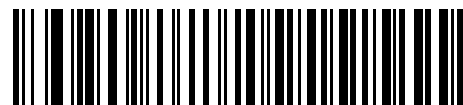

Spanish Windows

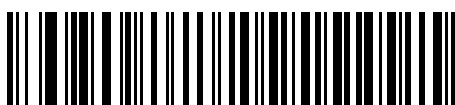

Italian Windows

Keyboard Wedge Country Types (Country Codes continued)

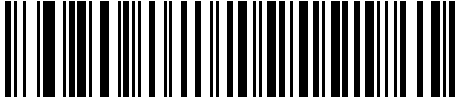

Swedish Windows



UK English Windows



Japanese Windows

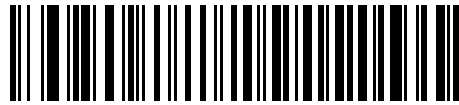

Portuguese-Brazilian Windows

Ignore Unknown Characters

Unknown characters are characters the host does not recognize. When **Send Bar Codes With Unknown Characters** is selected, all bar code data is sent except for unknown characters, and no error beeps sound on the scanner. When **Do Not Send Bar Codes With Unknown Characters** is selected, bar code data is sent up to the first unknown character, then the scanner issues an error beep.

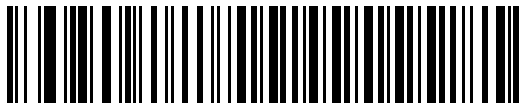

*Send Bar Codes with Unknown Characters



Do Not Send Bar Codes with Unknown Characters



Keystroke Delay

This is the delay in milliseconds between emulated keystrokes. Scan a bar code below to increase the delay when hosts require a slower transmission of data.



***No Delay**



Medium Delay (20 msec)

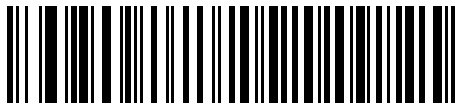

Long Delay (40 msec)

Intra-Keystroke Delay

When enabled, an additional delay is inserted between each emulated key depression and release. This sets the Keystroke Delay parameter to a minimum of 5 msec as well.

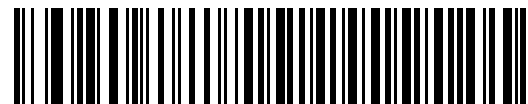

Enable Intra-Keystroke Delay



***Disable Intra-Keystroke Delay**

Alternate Numeric Keypad Emulation

This allows emulation of most other country keyboard types not listed in [Keyboard Wedge Country Types \(Country Codes\) on page 6-7](#) in a Microsoft® operating system environment.

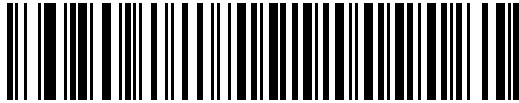

Enable Alternate Numeric Keypad



***Disable Alternate Numeric Keypad**

Caps Lock On

When enabled, the scanner emulates keystrokes as if the Caps Lock key is always pressed. Note that if both **Caps Lock On** and **Caps Lock Override** are enabled, **Caps Lock Override** takes precedence

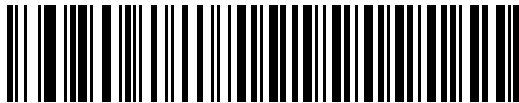

Enable Caps Lock On

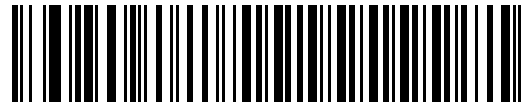

***Disable Caps Lock On**

Caps Lock Override

When enabled, on AT or AT Notebook hosts, the keyboard ignores the state of the Caps Lock key. Therefore, an 'A' in the bar code is sent as an 'A' no matter what the state of the keyboard's Caps Lock key.

Note that if both **Caps Lock On** and **Caps Lock Override** are enabled, **Caps Lock Override** takes precedence.



Enable Caps Lock Override

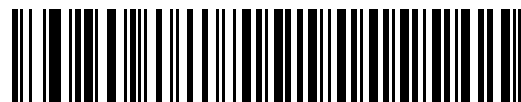

***Disable Caps Lock Override**



Convert Wedge Data

When enabled, the scanner converts all bar code data to the selected case.

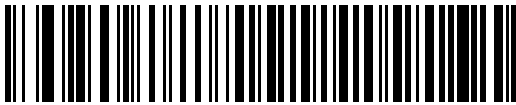

Convert to Upper Case



Convert to Lower Case

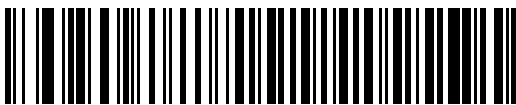

***No Convert**

Function Key Mapping

ASCII values under 32 are normally sent as control key sequences (see [Table 6-2 on page 6-14](#)). When this parameter is enabled, the keys in bold are sent in place of the standard key mapping. Table entries that do not have a bold entry remain the same whether or not this parameter is enabled.



Enable Function Key Mapping



***Disable Function Key Mapping**

FN1 Substitution

When enabled, the scanner replaces FN1 characters in an EAN128 bar code with a keystroke chosen by the user (see [FN1 Substitution Values on page 5-13](#)).

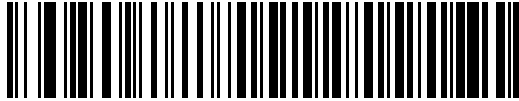

Enable FN1 Substitution

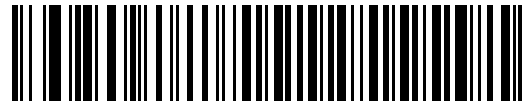

***Disable FN1 Substitution**

Send Make and Break

When enabled, the scan codes for releasing a key are not sent.

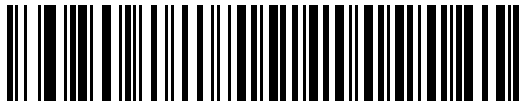

***Send Make and Break Scan Codes**

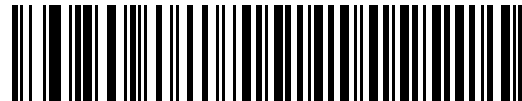

Send Make Scan Code Only



Keyboard Maps

The following keyboard maps are provided for prefix/suffix keystroke parameters. To program the prefix/suffix values, see the bar codes on page 5-11.

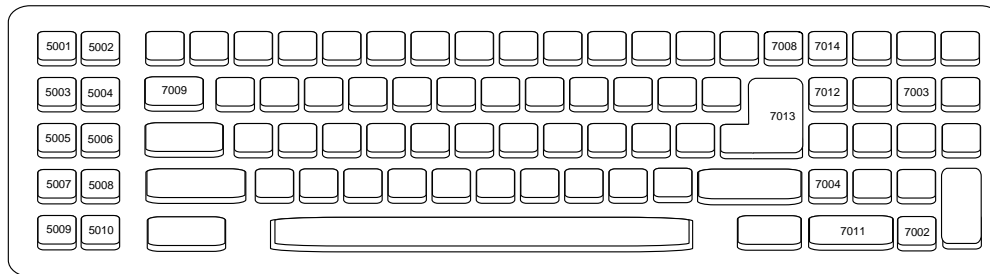

Figure 6-2. IBM PC/AT

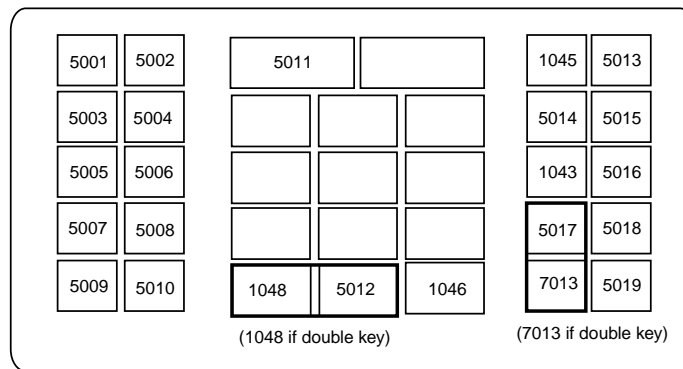

Figure 6-3. NCR 7052 32-KEY

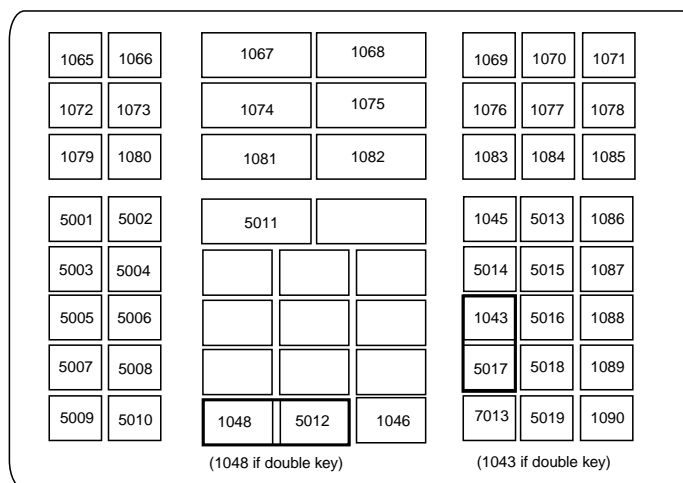

Figure 6-4. NCR 7052 58-KEY

ASCII Character Set for Keyboard Wedge



Code 39 Full ASCII interprets the bar code special character (\$ + % /) preceding a Code 39 character and assigns an ASCII character value to the pair. For example, when Code 39 Full ASCII is enabled and a **+B** is scanned, it is interpreted as **b**, **%J** as **?**, and **%V** as **@**. Scanning **ABC%I** outputs the keystroke equivalent of **ABC >**.

Table 6-2. Keyboard Wedge ASCII Character Set

ASCII Value	Full ASCII Code 39 Encode Character	Keystroke
1001	\$A	CTRL A
1002	\$B	CTRL B
1003	\$C	CTRL C
1004	\$D	CTRL D
1005	\$E	CTRL E
1006	\$F	CTRL F
1007	\$G	CTRL G
1008	\$H	CTRL H/ BACKSPACE ¹
1009	\$I	CTRL I/ HORIZONTAL TAB ¹
1010	\$J	CTRL J
1011	\$K	CTRL K
1012	\$L	CTRL L
1013	\$M	CTRL M/ ENTER ¹
1014	\$N	CTRL N
1015	\$O	CTRL O
1016	\$P	CTRL P
1017	\$Q	CTRL Q
1018	\$R	CTRL R
1019	\$S	CTRL S
1020	\$T	CTRL T
1021	\$U	CTRL U
1022	\$V	CTRL V
1023	\$W	CTRL W
1024	\$X	CTRL X
1025	\$Y	CTRL Y
1026	\$Z	CTRL Z
1027	%A	CTRL [/ ESC ¹

¹The keystroke in bold is sent only if the "Function Key Mapping" is enabled. Otherwise, the unbolded keystroke is sent.

**Table 6-2. Keyboard Wedge ASCII Character Set (Continued)**

ASCII Value	Full ASCII Code 39 Encode Character	Keystroke
1028	%B	CTRL \
1029	%C	CTRL]
1030	%D	CTRL 6
1031	%E	CTRL -
1032	Space	Space
1033	/A	!
1034	/B	"
1035	/C	#
1036	/D	\$
1037	/E	%
1038	/F	&
1039	/G	'
1040	/H	(
1041	/I)
1042	/J	*
1043	/K	+
1044	/L	,
1045	-	-
1046	.	.
1047	/O	/
1048	0	0
1049	1	1
1050	2	2
1051	3	3
1052	4	4
1053	5	5
1054	6	6
1055	7	7
1056	8	8
1057	9	9
1058	/Z	:
1059	%F	;
1060	%G	<

¹The keystroke in bold is sent only if the "Function Key Mapping" is enabled. Otherwise, the unbolded keystroke is sent.

Table 6-2. Keyboard Wedge ASCII Character Set (Continued)

ASCII Value	Full ASCII Code 39 Encode Character	Keystroke
1061	%H	=
1062	%I	>
1063	%J	?
1064	%V	@
1065	A	A
1066	B	B
1067	C	C
1068	D	D
1069	E	E
1070	F	F
1071	G	G
1072	H	H
1073	I	I
1074	J	J
1075	K	K
1076	L	L
1077	M	M
1078	N	N
1079	O	O
1080	P	P
1081	Q	Q
1082	R	R
1083	S	S
1084	T	T
1085	U	U
1086	V	V
1087	W	W
1088	X	X
1089	Y	Y
1090	Z	Z
1091	%K	[
1092	%L	\
1093	%M]

¹The keystroke in bold is sent only if the "Function Key Mapping" is enabled. Otherwise, the unbolded keystroke is sent.

**Table 6-2. Keyboard Wedge ASCII Character Set (Continued)**

ASCII Value	Full ASCII Code 39 Encode Character	Keystroke
1094	%N	^
1095	%O	_
1096	%W	'
1097	+A	a
1098	+B	b
1099	+C	c
1100	+D	d
1101	+E	e
1102	+F	f
1103	+G	g
1104	+H	h
1105	+I	i
1106	+J	j
1107	+K	k
1108	+L	l
1109	+M	m
1110	+N	n
1111	+O	o
1112	+P	p
1113	+Q	q
1114	+R	r
1115	+S	s
1116	+T	t
1117	+U	u
1118	+V	v
1119	+W	w
1120	+X	x
1121	+Y	y
1122	+Z	z
1123	%P	{
1124	%Q	
1125	%R	}
1126	%S	~

¹The keystroke in bold is sent only if the "Function Key Mapping" is enabled. Otherwise, the unbolded keystroke is sent.

Table 6-3. Keyboard Wedge ALT Key Character Set

ALT Keys	Keystroke
2065	ALT A
2066	ALT B
2067	ALT C
2068	ALT D
2069	ALT E
2070	ALT F
2071	ALT G
2072	ALT H
2073	ALT I
2074	ALT J
2075	ALT K
2076	ALT L
2077	ALT M
2078	ALT N
2079	ALT O
2080	ALT P
2081	ALT Q
2082	ALT R
2083	ALT S
2084	ALT T
2085	ALT U
2086	ALT V
2087	ALT W
2088	ALT X
2089	ALT Y
2090	ALT Z

Table 6-4. Keyboard Wedge GUI Key Character Set

GUI Keys	Keystrokes
3000	Right Control Key
3048	GUI 0
3049	GUI 1
3050	GUI 2
3051	GUI 3
3052	GUI 4



Table 6-4. Keyboard Wedge GIU Key Character Set (Continued)

GUI Keys	Keystrokes
3053	GUI 5
3054	GUI 6
3055	GUI 7
3056	GUI 8
3057	GUI 9
3065	GUI A
3066	GUI B
3067	GUI C
3068	GUI D
3069	GUI E
3070	GUI F
3071	GUI G
3072	GUI H
3073	GUI I
3074	GUI J
3075	GUI K
3076	GUI L
3077	GUI M
3078	GUI N
3079	GUI O
3080	GUI P
3081	GUI Q
3082	GUI R
3083	GUI S
3084	GUI T
3085	GUI U
3086	GUI V
3087	GUI W
3088	GUI X
3089	GUI Y
3090	GUI Z

Table 6-5. Keyboard Wedge F Key Character Set

F Keys	Keystroke
5001	F1
5002	F2
5003	F3
5004	F4
5005	F5
5006	F6
5007	F7
5008	F8
5009	F9
5010	F10
5011	F11
5012	F12
5013	F13
5014	F14
5015	F15
5016	F16
5017	F17
5018	F18
5019	F19
5020	F20
5021	F21
5022	F22
5023	F23
5024	F24

Table 6-6. Keyboard Wedge Numeric Keypad Character Set

Numeric Keypad	Keystroke
6042	*
6043	+
6044	undefined
6045	-
6046	.
6047	/



Table 6-6. Keyboard Wedge Numeric Keypad Character Set (Continued)

Numeric Keypad	Keystroke
6048	0
6049	1
6050	2
6051	3
6052	4
6053	5
6054	6
6055	7
6056	8
6057	9
6058	Enter
6059	Num Lock

Table 6-7. Keyboard Wedge Extended Keypad Character Set

Extended Keypad	Keystroke
7001	Break
7002	Delete
7003	Pg Up
7004	End
7005	Pg Dn
7006	Pause
7007	Scroll Lock
7008	Backspace
7009	Tab
7010	Print Screen
7011	Insert
7012	Home
7013	Enter
7014	Escape
7015	Up Arrow
7016	Dn Arrow
7017	Left Arrow
7018	Right Arrow

RS-232 Interface

Introduction	7-3
Connecting an RS-232 Interface	7-4
RS-232 Parameter Defaults	7-5
RS-232 Host Parameters	7-6
RS-232 Host Types	7-8
Baud Rate	7-9
Parity	7-10
Stop Bit Select	7-11
Data Bits (ASCII Format)	7-11
Check Receive Errors	7-12
Hardware Handshaking	7-12
Software Handshaking	7-14
Host Serial Response Time-out	7-15
RTS Line State	7-16
Beep on <BEL>	7-16
Intercharacter Delay	7-17
Nixdorf Beep/LED Options	7-18
Ignore Unknown Characters	7-18
ASCII Character Set for RS-232	7-19



Introduction

This chapter provides instructions for programming the cradle to interface with an RS-232 host interface. The RS-232 interface is used to attach the scanner cradle to point-of-sale devices, host computers, or other devices with an available RS-232 port (i.e., COM port).

If the particular host is not listed in Table 6-2, set the communication parameters to match the host device. Refer to the documentation for the host device.



This scanner uses TTL RS-232 signal levels, which interface with most system architectures. For system architectures requiring RS-232C signal levels, Symbol offers different cables providing the TTL to RS-232C conversion. Contact the [Symbol Support Center](#) for more information.

Throughout the programming bar code menus, default values are indicated with asterisks (*).



* Indicates Default ————— ***Baud Rate 57,600** ————— Feature/Option

Connecting an RS-232 Interface

Note

See [Chapter 4, Radio Communications](#) for information about scanner/cradle pairing and wireless communication.

The scanner must be connected to the cradle for the host parameter setting to take effect. When the scanner is not connected to a cradle, and a host parameter bar code is scanned, a long low/long high beep sequence sounds.

This connection is made directly from the cradle to the host computer.

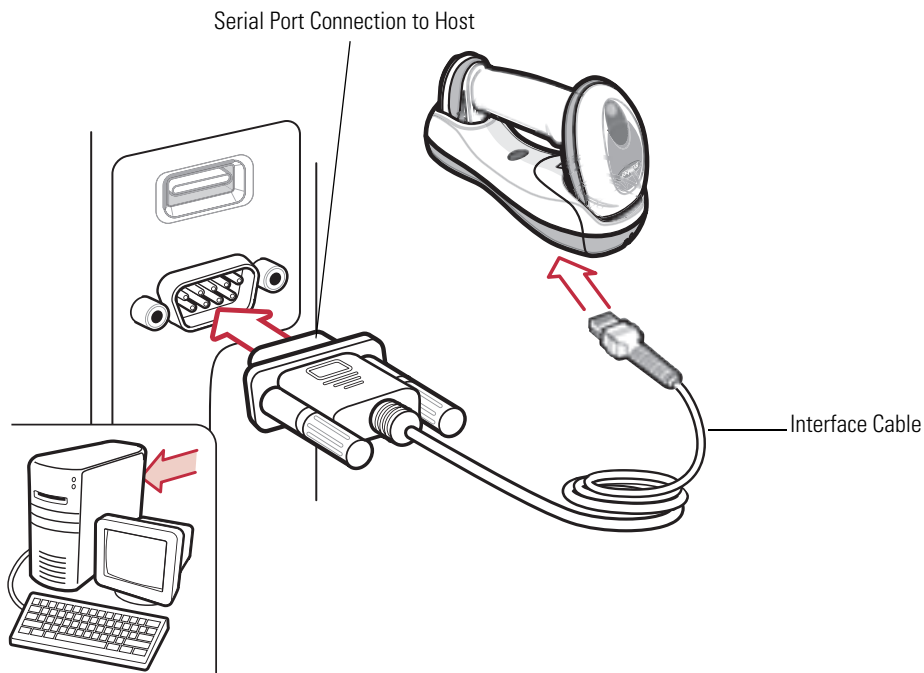

Figure 7-1. RS-232 Direct Connection

To connect the RS-232 interface:

1. Attach the modular connector of the RS-232 interface cable to the host port on the bottom of the scanner cradle (see [Connecting the Cradle on page 1-8](#)).
2. Connect the other end of the RS-232 interface cable to the serial port on the host.
3. Connect the power supply to the serial connector end of the RS-232 interface cable. Plug the power supply into an appropriate outlet.
4. Select the RS-232 host type by scanning the appropriate bar code from [RS-232 Host Types on page 7-8](#).
5. To modify any other parameter options, scan the appropriate bar codes in this chapter.

Note

Interface cables vary depending on configuration. The connectors illustrated in [Figure 7-1](#) are examples only. The connectors may be different than those illustrated, but the steps to connect the cradle remain the same.

If a power supply is used, disconnect the power supply before changing host cables or the cradle may not recognize the new host.

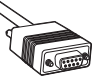

RS-232 Parameter Defaults

Table 7-1 lists the defaults for RS-232 host parameters. If any option needs to be changed, scan the appropriate bar code(s) provided in the Parameter Descriptions section beginning on page 7-6.



Note

See [Appendix A, Standard Default Parameters](#) for all user preferences, hosts, symbologies, and miscellaneous default parameters.

Table 7-1. RS-232 Host Default Table

Parameter	Default	Page Number
RS-232 Host Parameters		
RS-232 Host Types	Standard	7-8
Baud Rate	9600	7-9
Parity Type	None	7-10
Stop Bit Select	1 Stop Bit	7-11
Data Bits (ASCII Format)	8-Bit	7-11
Check Receive Errors	Enable	7-12
Hardware Handshaking	None	7-13
Software Handshaking	None	7-14
Host Serial Response Time-out	2 sec	7-15
RTS Line State	Low RTS	7-16
Beep on <BEL>	Disable	7-16
Intercharacter Delay	0 msec	7-17
Nixdorf Beep/LED Options	Normal Operation	7-18
Ignore Unknown Characters	Send Bar Code	7-18

RS-232 Host Parameters

Various RS-232 hosts are set up with their own parameter default settings (Table 7-2). Selecting the ICL, Fujitsu, Wincor-Nixdorf Mode A, Wincor-Nixdorf Mode B, Olivetti, Omron, or terminal sets the defaults listed below.

Table 7-2. Terminal Specific RS-232

Parameter	Standard (Default)	ICL	Fujitsu	Wincor- Nixdorf Mode A	Wincor-Nixdorf Mode B/OPOS	Olivetti	Omron
Transmit Code ID	No	Yes	Yes	Yes	Yes	Yes	Yes
Data Transmission Format	Data as is	Data/Suffix	Data/Suffix	Data/Suffix	Data/Suffix	Prefix/Data/Suffix	Data/Suffix
Suffix	CR/LF (7013)	CR (1013)	CR (1013)	CR (1013)	CR (1013)	ETX (1002)	CR (1013)
Baud Rate	9600	9600	9600	9600	9600	9600	9600
Parity	None	Even	None	Odd	Odd	Even	None
Hardware Handshaking	None	RTS/CTS Option 3	None	RTS/CTS Option 3	RTS/CTS Option 3	None	None
Software Handshaking	None	None	None	None	None	Ack/Nak	None
Serial Response Time-out	2 sec.	9.9 sec.	2 sec.	9.9 sec.	9.9 sec.	9.9 sec.	9.9 sec.
Stop Bit Select	One	One	One	One	One	One	One
ASCII Format	8-Bit	8-Bit	8-Bit	8-Bit	8-Bit	7-Bit	8-Bit
Beep On <BEL>	Disable	Disable	Disable	Disable	Disable	Disable	Disable
RTS Line State	Low	High	Low	Low	Low = No data to send	Low	High
Prefix	None	None	None	None	None	STX (1003)	None

*In the Nixdorf Mode B, if CTS is Low, scanning is disabled. When CTS is High, the user can scan bar codes.

**If Nixdorf Mode B is scanned without the cradle connected to the proper host, the scanner may appear unable to scan. If this happens, scan a different RS-232 host type within 5 seconds of cycling power to the cradle.

RS-232 Host Types

To select an RS-232 host interface, scan one of the following bar codes.

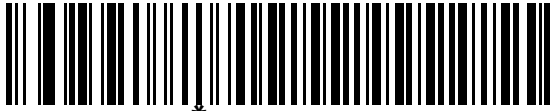

***Standard RS-232**

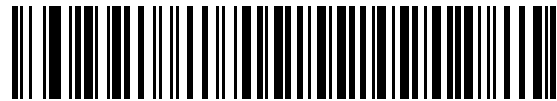

ICL RS-232

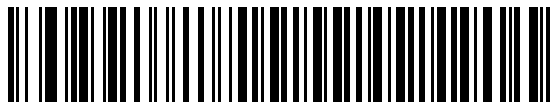

Wincor-Nixdorf RS-232 Mode A

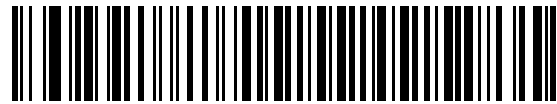

Wincor-Nixdorf RS-232 Mode B

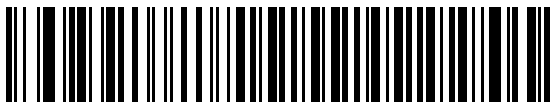

Olivetti ORS4500

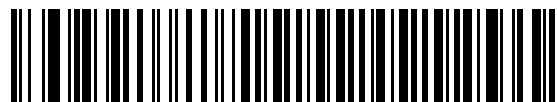

Omron



OPOS/JPOS

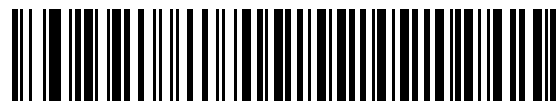

Fujitsu RS-232



Baud Rate

Baud rate is the number of bits of data transmitted per second. Set the scanner's baud rate to match the baud rate setting of the host device. Otherwise, data may not reach the host device or may reach it in distorted form.



Baud Rate 600

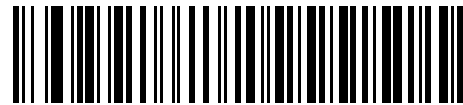

Baud Rate 1200

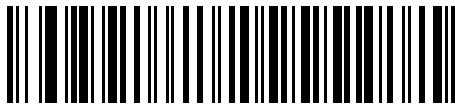

Baud Rate 2400



Baud Rate 4800

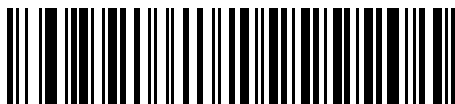

*** Baud Rate 9600**

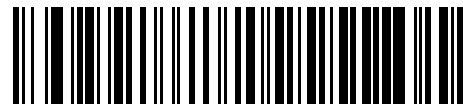

Baud Rate 19,200

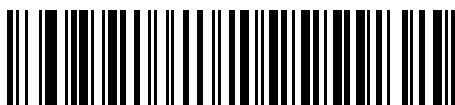

Baud Rate 38,400

Parity

A parity check bit is the most significant bit of each ASCII coded character. Select the parity type according to host device requirements.

- Select **Odd** parity and the parity bit value is set to 0 or 1, based on data, to ensure that an odd number of 1 bits are contained in the coded character.
- Select **Even** parity and the parity bit value is set to 0 or 1, based on data, to ensure that an even number of 1 bits are contained in the coded character.
- Select **Mark** parity and the parity bit is always 1.
- Select **Space** parity and the parity bit is always 0.
- Select **None** when no parity bit is required.

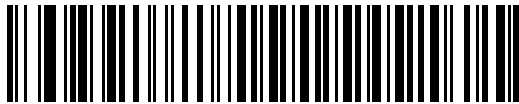

Odd



Even

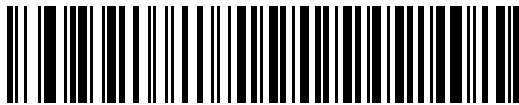

Mark



Space



***None**



Stop Bit Select

The stop bit(s) at the end of each transmitted character marks the end of transmission of one character and prepares the receiving device for the next character in the serial data stream. The number of stop bits selected (one or two) depends on the number the receiving terminal is programmed to accommodate. Set the number of stop bits to match host device requirements.



***1 Stop Bit**



2 Stop Bits

Data Bits (ASCII Format)

This parameter allows the scanner to interface with devices requiring a 7-bit or 8-bit ASCII protocol.

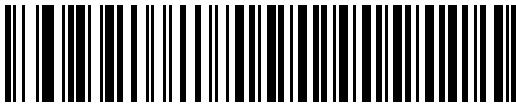

7-Bit

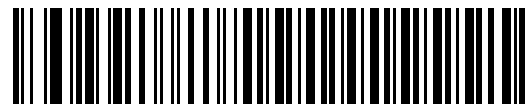

***8-Bit**

Check Receive Errors

Select whether or not the parity, framing, and overrun of received characters are checked. The parity value of received characters is verified against the parity parameter selected above.



***Check For Received Errors
(Enable)**

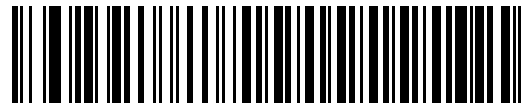

**Do Not Check For Received Errors
(Disable)**

Hardware Handshaking

The data interface consists of an RS-232 port designed to operate either with or without the hardware handshaking lines, *Request to Send* (RTS), and *Clear to Send* (CTS).

If Standard RTS/CTS handshaking is not selected, scan data is transmitted as it becomes available. If Standard RTS/CTS handshaking is selected, scan data is transmitted according to the following sequence:

- The scanner reads the CTS line for activity. If CTS is asserted, the scanner waits up to Host Serial Response Time-out for the host to de-assert the CTS line. If, after Host Serial Response Time-out, the CTS line is still asserted, the scanner sounds a transmit error, and any scanned data is lost.
- When the CTS line is de-asserted, the scanner asserts the RTS line and waits up to Host Serial Response Time-out for the host to assert CTS. When the host asserts CTS, data is transmitted. If, after Host Serial Response Time-out, the CTS line is not asserted, the scanner sounds a transmit error, and discards the data.
- When data transmission is complete, the scanner de-asserts RTS 10 msec after sending the last character.
- The host should respond by negating CTS. The scanner checks for a de-asserted CTS upon the next transmission of data.

During the transmission of data, the CTS line should be asserted. If CTS is de-asserted for more than 50 ms between characters, the transmission is aborted, the scanner sounds a transmission error, and the data is discarded.

If the above communication sequence fails, the scanner issues an error indication. In this case, the data is lost and must be rescanned.

If Hardware Handshaking and Software Handshaking are both enabled, Hardware Handshaking takes precedence.



The DTR signal is jumpered to the active state.

- **None:** Scan the bar code below if no Hardware Handshaking is desired.
- **Standard RTS/CTS:** Scan the bar code below to select Standard RTS/CTS Hardware Handshaking.



- **RTS/CTS Option 1:** When RTS/CTS Option 1 is selected, the scanner asserts RTS before transmitting and ignores the state of CTS. The scanner de-asserts RTS when the transmission is complete.
- **RTS/CTS Option 2:** When Option 2 is selected, RTS is always high or low (user-programmed logic level). However, the scanner waits for CTS to be asserted before transmitting data. If CTS is not asserted within Host Serial Response Time-out, the scanner issues an error indication and discards the data.
- **RTS/CTS Option 3:** When Option 3 is selected, the scanner asserts RTS prior to any data transmission, regardless of the state of CTS. The scanner waits up to Host Serial Response Time-out for CTS to be asserted. If CTS is not asserted during this time, the scanner issues an error indication and discards the data. The scanner de-asserts RTS when transmission is complete.

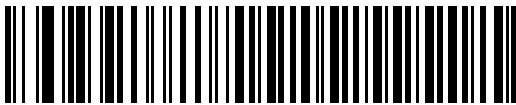

*None

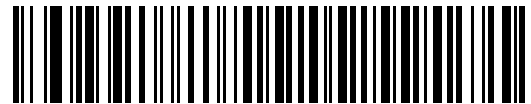

Standard RTS/CTS



RTS/CTS Option 1



RTS/CTS Option 2



RTS/CTS Option 3

Software Handshaking

This parameter offers control of the data transmission process in addition to, or instead of, that offered by hardware handshaking. There are five options.

If Software Handshaking and Hardware Handshaking are both enabled, Hardware Handshaking takes precedence.

- **None:** When this option is selected, data is transmitted immediately. No response is expected from host.
- **ACK/NAK:** When this option is selected, after transmitting data, the scanner expects either an ACK or NAK response from the host. When a NAK is received, the scanner transmits the same data again and waits for either an ACK or NAK. After three unsuccessful attempts to send data when NAKs are received, the scanner issues an error indication and discards the data.

The scanner waits up to the programmable Host Serial Response Time-out to receive an ACK or NAK. If the scanner does not get a response in this time, it issues an error indication and discards the data. There are no retries when a time-out occurs.

- **ENQ:** When this option is selected, the scanner waits for an ENQ character from the host before transmitting data. If an ENQ is not received within the Host Serial Response Time-out, the scanner issues an error indication and discards the data. The host must transmit an ENQ character at least every Host Serial Response Time-out to prevent transmission errors.
- **ACK/NAK with ENQ:** This combines the two previous options. For re-transmissions of data, due to a NAK from the host, an additional ENQ is not required.
- **XON/XOFF:** An XOFF character turns the scanner transmission off until the scanner receives an XON character. There are two situations for XON/XOFF:
 - XOFF is received before the scanner has data to send. When the scanner has data to send, it waits up to Host Serial Response Time-out for an XON character before transmission. If the XON is not received within this time, the scanner issues an error indication and discards the data.
 - XOFF is received during a transmission. Data transmission then stops after sending the current byte. When the scanner receives an XON character, it sends the rest of the data message. The scanner waits up to 30 seconds for the XON.

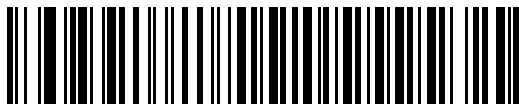

*None



ACK/NAK



ENQ

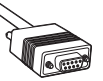

Software Handshaking (continued)



ACK/NAK with ENQ

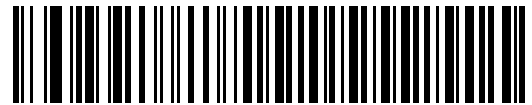

XON/XOFF

Host Serial Response Time-out

This parameter specifies how long the scanner waits for an ACK, NAK, ENQ, XON, or CTS before determining that a transmission error occurred.

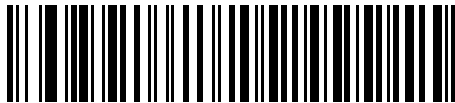

*Minimum: 2 sec



Low: 2.5 sec

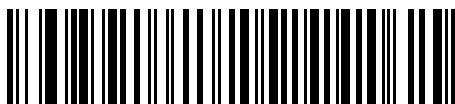

Medium: 5 sec

Host Serial Response Time-out (continued)

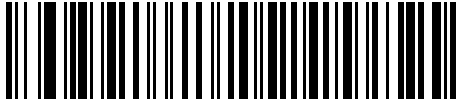

High: 7.5 sec

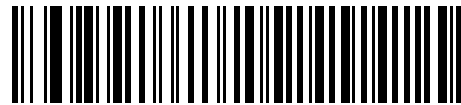

Maximum: 9.9 sec

RTS Line State

This parameter sets the idle state of the Serial Host RTS line. Scan a bar code below to select **Low RTS** or **High RTS** line state.

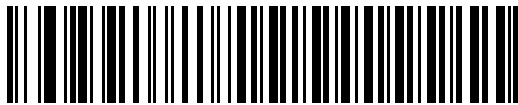

***Host: Low RTS**

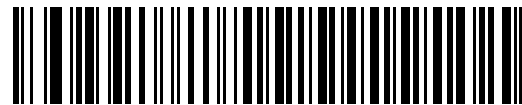

Host: High RTS

Beep on <BEL>

When this parameter is enabled, the scanner issues a beep when a <BEL> character is detected on the RS-232 serial line. <BEL> is issued to gain a user's attention to an illegal entry or other important event.

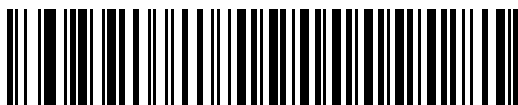

**Beep On <BEL> Character
(Enable)**

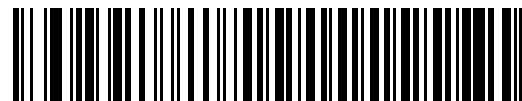

***Do Not Beep On <BEL> Character
(Disable)**

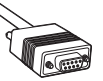

Intercharacter Delay

This parameter specifies the intercharacter delay inserted between character transmissions.



***Minimum: 0 msec**

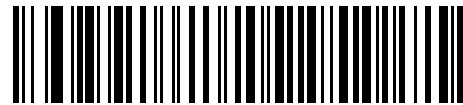

Low: 25 msec

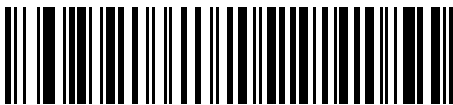

Medium: 50 msec



High: 75 msec

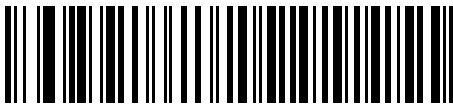

Maximum: 99 msec

Nixdorf Beep/LED Options

When Nixdorf Mode B is selected, this indicates when the scanner should beep and turn on its LED after a decode.



***Normal Operation**
(Beep/LED immediately after decode)

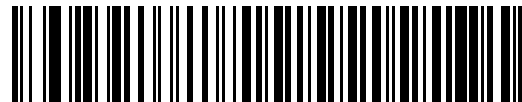

Beep/LED After Transmission

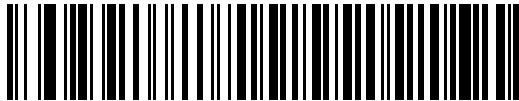

Beep/LED After CTS Pulse

Ignore Unknown Characters

Unknown characters are characters the host does not recognize. When **Send Bar Codes with Unknown Characters** is selected, all bar code data is sent except for unknown characters, and no error beeps sound on the scanner. When **Do Not Send Bar Codes With Unknown Characters** is selected, bar code data is sent up to the first unknown character and then an error beep sounds on the scanner.

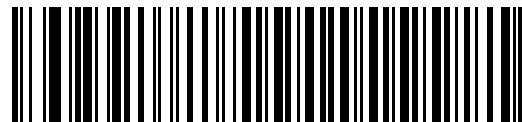

***Send Bar Code with Unknown Characters**



Do Not Send Bar Codes with Unknown Characters

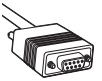

ASCII Character Set for RS-232

The values in [Table 7-4](#) can be assigned as prefixes or suffixes for ASCII character data transmission.

Table 7-4. ASCII Character Set for RS-232

ASCII Value	Full ASCII Code 39 Encode Character	ASCII Character
1000	%U	NUL
1001	\$A	SOH
1002	\$B	STX
1003	\$C	ETX
1004	\$D	EOT
1005	\$E	ENQ
1006	\$F	ACK
1007	\$G	BELL
1008	\$H	BCKSPC
1009	\$I	HORIZ TAB
1010	\$J	LF/NW LN
1011	\$K	VT
1012	\$L	FF
1013	\$M	CR/ENTER
1014	\$N	SO
1015	\$O	SI
1016	\$P	DLE
1017	\$Q	DC1/XON
1018	\$R	DC2
1019	\$S	DC3/XOFF
1020	\$T	DC4
1021	\$U	NAK
1022	\$V	SYN
1023	\$W	ETB
1024	\$X	CAN
1025	\$Y	EM
1026	\$Z	SUB
1027	%A	ESC
1028	%B	FS
1029	%C	GS
1030	%D	RS
1031	%E	US
1032	Space	Space

Table 7-4. ASCII Character Set for RS-232 (Continued)

ASCII Value	Full ASCII Code 39 Encode Character	ASCII Character
1033	/A	!
1034	/B	"
1035	/C	#
1036	/D	\$
1037	/E	%
1038	/F	&
1039	/G	'
1040	/H	(
1041	/I)
1042	/J	*
1043	/K	+
1044	/L	,
1045	-	-
1046	.	.
1047	/O	/
1048	0	0
1049	1	1
1050	2	2
1051	3	3
1052	4	4
1053	5	5
1054	6	6
1057	7	7
1056	8	8
1057	9	9
1058	/Z	:
1059	%F	;
1060	%G	<
1061	%H	=
1062	%I	>
1063	%J	?
1064	%V	@
1065	A	A
1066	B	B
1067	C	C

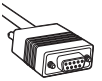
**Table 7-4. ASCII Character Set for RS-232 (Continued)**

ASCII Value	Full ASCII Code 39 Encode Character	ASCII Character
1068	D	D
1069	E	E
1070	F	F
1071	G	G
1072	H	H
1073	I	I
1074	J	J
1075	K	K
1076	L	L
1077	M	M
1078	N	N
1079	O	O
1080	P	P
1081	Q	Q
1082	R	R
1083	S	S
1084	T	T
1085	U	U
1086	V	V
1087	W	W
1088	X	X
1089	Y	Y
1090	Z	Z
1091	%K	[
1092	%L	\
1093	%M]
1094	%N	^
1095	%O	_
1096	%W	`
1097	+A	a
1098	+B	b
1099	+C	c
1100	+D	d
1101	+E	e
1102	+F	f

Table 7-4. ASCII Character Set for RS-232 (Continued)

ASCII Value	Full ASCII Code 39 Encode Character	ASCII Character
1103	+G	g
1104	+H	h
1105	+I	i
1106	+J	j
1107	+K	k
1108	+L	l
1109	+M	m
1110	+N	n
1111	+O	o
1112	+P	p
1113	+Q	q
1114	+R	r
1115	+S	s
1116	+T	t
1117	+U	u
1118	+V	v
1119	+W	w
1120	+X	x
1121	+Y	y
1122	+Z	z
1123	%P	{
1124	%Q	
1125	%R	}
1126	%S	~
1127		Undefined
7013		ENTER

8

USB Interface

Introduction	8-3
Connecting a USB Interface	8-4
USB Parameter Defaults	8-5
USB Host Parameters	8-6
USB Device Type	8-6
USB Country Keyboard Types (Country Codes)	8-7
USB Keystroke Delay	8-9
USB CAPS Lock Override	8-9
USB Ignore Unknown Characters	8-10
Emulate Keypad	8-10
USB Keyboard FN 1 Substitution	8-11
Function Key Mapping	8-11
Simulated Caps Lock	8-12
Convert Case	8-12
Optional USB Parameters	8-13
Ignore Beep	8-13
Ignore Bar Code Configuration	8-13
ASCII Character Set for USB	8-14

Introduction

This chapter provides instructions for programming the cradle to interface with a USB host. The scanner cradle connects directly to a USB host, or a powered USB hub. The USB host can power the cradle and recharge the scanner battery, but this charging method has limitations. See [Using the USB Interface to Supply Power on page 1-9](#).

Throughout the programming bar code menus, default values are indicated with asterisks (*).



* Indicates Default *North American Standard USB Keyboard—— Feature/Option

Connecting a USB Interface



See [Chapter 4, Radio Communications](#) for information about scanner/cradle pairing and wireless communication

The scanner must be connected to the cradle for the host parameter setting to take effect. When the scanner is not connected to a cradle, and a host parameter bar code is scanned, a long low/long high beep sequence sounds.

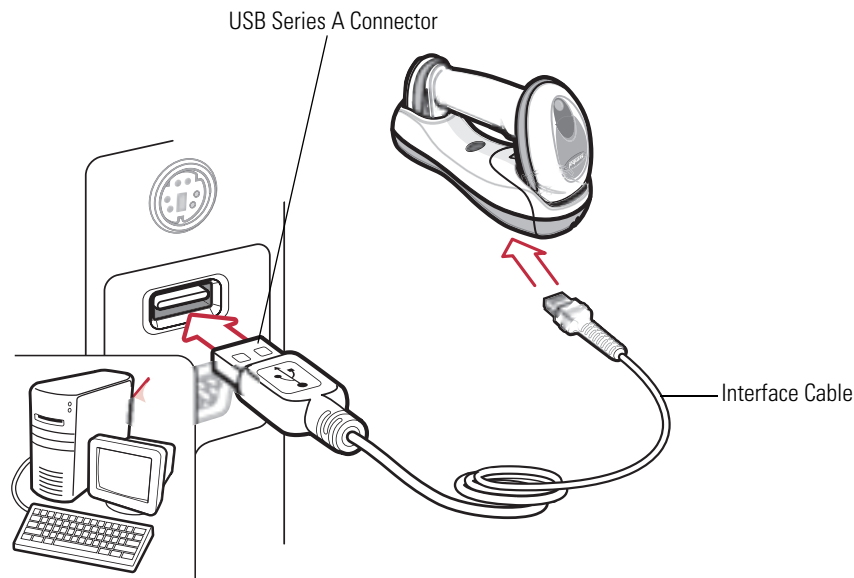

Figure 8-1. USB Connection

The scanner cradle connects with USB capable hosts including:

- Desktop PCs and Notebooks
- Apple™ iMac, G4, iBooks (North America only)
- IBM SurePOS terminals
- Sun, IBM, and other network computers that support more than one keyboard.

The following operating systems support the scanner cradle through USB:

- Windows 98, 2000, ME, XP
- MacOS 8.5 and above
- IBM 4690 OS.

The scanner cradle also interfaces with other USB hosts which support USB Human Interface Devices (HID). For more information on USB technology, hosts, and peripheral devices, visit www.symbol.com/usb.

To connect the USB interface:

1. Attach the modular connector of the USB interface cable to the host port on the bottom of the scanner cradle (see [Connecting the Cradle on page 1-8](#)).

2. Plug the series A connector in the USB host or hub, or plug the Plus Power connector in an available port of the IBM SurePOS terminal.
3. Select the USB device type by scanning the appropriate bar code from [USB Device Type on page 8-6](#).
4. On first installation when using Windows, the software prompts to select or install the Human Interface Device driver. To install this driver, provided by Windows, click *Next* through all the choices and click *Finished* on the last choice. The cradle powers up during this installation.
5. To modify any other parameter options, scan the appropriate bar codes in this chapter.



Interface cables vary depending on configuration. The connectors illustrated in [Figure 8-1](#) are examples only. The connectors may be different than those illustrated, but the steps to connect the scanner cradle remain the same.

If problems occur with the system, see [Troubleshooting on page 3-4](#).

USB Parameter Defaults

[Table 8-1](#) lists the defaults for USB host parameters. If any option needs to be changed, scan the appropriate bar code(s) provided in the Parameter Descriptions section beginning on page [8-6](#).



See [Appendix A, Standard Default Parameters](#) for all user preferences, hosts, symbologies, and miscellaneous default parameters.

Table 8-1. USB Host Default Table

Parameter	Default	Page Number
USB Host Parameters		
USB Device Type	HID Keyboard Emulation	8-6
USB Country Keyboard Types (Country Codes)	North American	8-7
USB Keystroke Delay	No Delay	8-9
USB CAPS Lock Override	Disable	8-9
USB Ignore Unknown Characters	Send	8-10
Emulate Keypad	Disable	8-10
USB FN1 Substitution	Disable	8-11
Function Key Mapping	Disable	8-11
Simulated Caps Lock	Disable	8-12
Convert Case	No Case Conversion	8-12

USB Host Parameters

USB Device Type

Select the desired USB device type.



When changing USB Device Types, the scanner automatically restarts. The scanner issues the standard startup beep sequences.

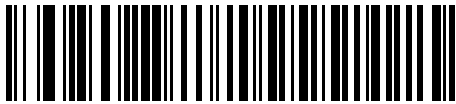

***HID Keyboard Emulation**



IBM Table Top USB

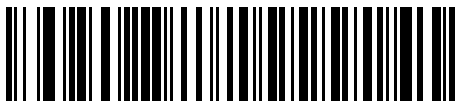

IBM Hand-Held USB



USB OPOS Handheld

USB Country Keyboard Types (Country Codes)

Scan the bar code corresponding to the keyboard type. This setting applies only to the USB HID Keyboard Emulation device.



When changing USB country keyboard types the scanner automatically resets. The scanner issues the standard startup beep sequences.

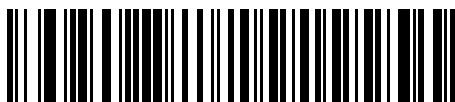

***North American Standard USB Keyboard**



German Windows

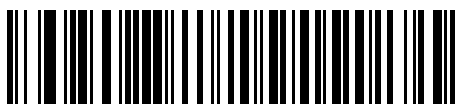

French Windows



French Canadian Windows 95/98



French Canadian Windows 2000/XP



Spanish Windows

USB Country Keyboard Types (Country Codes continued)



Italian Windows



Swedish Windows



UK English Windows



Japanese Windows (ASCII)

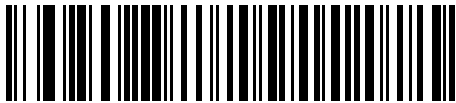

Portuguese-Brazilian Windows

USB Keystroke Delay

This parameter sets the delay, in milliseconds, between emulated keystrokes. Scan a bar code below to increase the delay when hosts require a slower transmission of data.



***No Delay**



Medium Delay (20 msec)

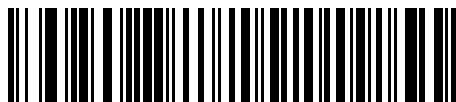

Long Delay (40 msec)

USB CAPS Lock Override

This option applies only to the HID Keyboard Emulation device. When enabled, the case of the data is preserved regardless of the state of the caps lock key. This setting is always enabled for the “Japanese, Windows (ASCII)” keyboard type and can not be disabled.



**Override Caps Lock Key
(Enable)**



***Do Not Override Caps Lock Key
(Disable)**

USB Ignore Unknown Characters

This option applies only to the HID Keyboard Emulation device and IBM device. Unknown characters are characters the host does not recognize. When **Send Bar Codes With Unknown Characters** is selected, all bar code data is sent except for unknown characters, and no error beeps sound. When **Do Not Send Bar Codes With Unknown Characters** is selected, bar code data is sent up to the first unknown character, then the scanner issues an error beep.



***Send Bar Codes with Unknown Characters**

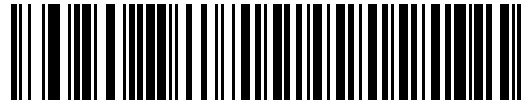

Do Not Send Bar Codes with Unknown Characters

Emulate Keypad

When enabled, all characters are sent as ASCII sequences over the numeric keypad. For example ASCII A would be sent as "ALT make" 0 6 5 "ALT Break."



***Disable Keypad Emulation**

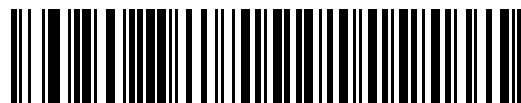

Enable Keypad Emulation

USB Keyboard FN 1 Substitution

This option applies only to the USB HID Keyboard Emulation device. When enabled, this allows replacement of any FN 1 characters in an EAN 128 bar code with a Key Category and value chosen by the user (see [FN1 Substitution Values on page 5-13](#) to set the Key Category and Key Value).

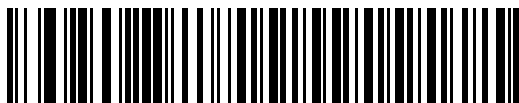

Enable FN1 Substitution



***Disable FN1 Substitution**

Function Key Mapping

ASCII values under 32 are normally sent as a control-key sequences (see [Table 8-2 on page 8-14](#)). When this parameter is enabled, the keys in bold are sent in place of the standard key mapping. Table entries that do not have a bold entry remain the same whether or not this parameter is enabled.



***Disable Function Key Mapping**



Enable Function Key Mapping

Simulated Caps Lock

When enabled, the scanner inverts upper and lower case characters on the scanner bar code as if the Caps Lock state is enabled on the keyboard. This inversion is done regardless of the current state of the keyboard's Caps Lock state.



***Disable Simulated Caps Lock**

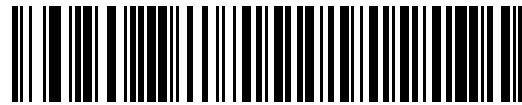

Enable Simulated Caps Lock

Convert Case

When enabled, the scanner converts all bar code data to the selected case.

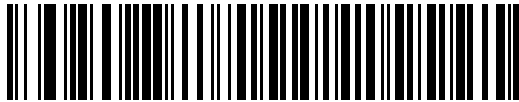

***No Case Conversion**

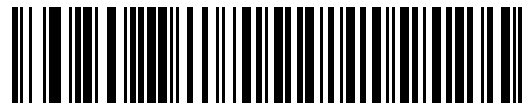

Convert All to Upper Case



Convert All to Lower Case

Optional USB Parameters

If you configure the scanner and find the settings were not saved, or changed, when the system is restarted scan the bar codes that follow to override USB interface defaults.

Scan a bar code below after setting defaults and before configuring the scanner.

Ignore Beep

The host can send a beep request to the scanner. When this parameter is enabled, the request is not sent to the attached scanner. All directives are still acknowledged to the USB host as if it were processed.



Disable



Enable

Ignore Bar Code Configuration

The host has the ability to enable/disable code types. When this parameter is enabled, the request is not sent to the attached scanner. All directives are still acknowledged to the USB host as if it were processed.



Disable



Enable

ASCII Character Set for USB

Table 8-2. ASCII Character Set for USB

ASCII Value	Full ASCII Code 39 Encode Character	Keystroke
1000	%U	CTRL 2
1001	\$A	CTRL A
1002	\$B	CTRL B
1003	\$C	CTRL C
1004	\$D	CTRL D
1005	\$E	CTRL E
1006	\$F	CTRL F
1007	\$G	CTRL G
1008	\$H	CTRL H/ BACKSPACE ¹
1009	\$I	CTRL I/ HORIZONTAL TAB ¹
1010	\$J	CTRL J
1011	\$K	CTRL K
1012	\$L	CTRL L
1013	\$M	CTRL M/ ENTER ¹
1014	\$N	CTRL N
1015	\$O	CTRL O
1016	\$P	CTRL P
1017	\$Q	CTRL Q
1018	\$R	CTRL R
1019	\$S	CTRL S
1020	\$T	CTRL T
1021	\$U	CTRL U
1022	\$V	CTRL V
1023	\$W	CTRL W
1024	\$X	CTRL X
1025	\$Y	CTRL Y
1026	\$Z	CTRL Z
1027	%A	CTRL [/b> ESC ¹
1028	%B	CTRL \
1029	%C	CTRL]
1030	%D	CTRL 6

¹The keystroke in bold is sent only if the "Function Key Mapping" is enabled. Otherwise, the unbolded keystroke is sent.



Table 8-2. ASCII Character Set for USB (Continued)

ASCII Value	Full ASCII Code 39 Encode Character	Keystroke
1031	%E	CTRL -
1032	Space	Space
1033	/A	!
1034	/B	"
1035	/C	#
1036	/D	\$
1037	/E	%
1038	/F	&
1039	/G	'
1040	/H	(
1041	/I)
1042	/J	*
1043	/K	+
1044	/L	,
1045	-	-
1046	.	.
1047	/O	/
1048	0	0
1049	1	1
1050	2	2
1051	3	3
1052	4	4
1053	5	5
1054	6	6
1055	7	7
1056	8	8
1057	9	9
1058	/Z	:
1059	%F	;
1060	%G	<
1061	%H	=
1062	%I	>
1063	%J	?

¹The keystroke in bold is sent only if the "Function Key Mapping" is enabled. Otherwise, the unbolded keystroke is sent.

Table 8-2. ASCII Character Set for USB (Continued)

ASCII Value	Full ASCII Code 39 Encode Character	Keystroke
1064	%V	@
1065	A	A
1066	B	B
1067	C	C
1068	D	D
1069	E	E
1070	F	F
1071	G	G
1072	H	H
1073	I	I
1074	J	J
1075	K	K
1076	L	L
1077	M	M
1078	N	N
1079	O	O
1080	P	P
1081	Q	Q
1082	R	R
1083	S	S
1084	T	T
1085	U	U
1086	V	V
1087	W	W
1088	X	X
1089	Y	Y
1090	Z	Z
1091	%K	[
1092	%L	\
1093	%M]
1094	%N	^
1095	%O	_
1096	%W	`

¹The keystroke in bold is sent only if the "Function Key Mapping" is enabled. Otherwise, the unbolded keystroke is sent.



Table 8-2. ASCII Character Set for USB (Continued)

ASCII Value	Full ASCII Code 39 Encode Character	Keystroke
1097	+A	a
1098	+B	b
1099	+C	c
1100	+D	d
1101	+E	e
1102	+F	f
1103	+G	g
1104	+H	h
1105	+I	i
1106	+J	j
1107	+K	k
1108	+L	l
1109	+M	m
1110	+N	n
1111	+O	o
1112	+P	p
1113	+Q	q
1114	+R	r
1115	+S	s
1116	+T	t
1117	+U	u
1118	+V	v
1119	+W	w
1120	+X	x
1121	+Y	y
1122	+Z	z
1123	%P	{
1124	%Q	
1125	%R	}
1126	%S	~

¹The keystroke in bold is sent only if the "Function Key Mapping" is enabled. Otherwise, the unbolded keystroke is sent.

Table 8-3. USB ALT Key Character Set

ALT Keys	Keystroke
2064	ALT 2
2065	ALT A
2066	ALT B
2067	ALT C
2068	ALT D
2069	ALT E
2070	ALT F
2071	ALT G
2072	ALT H
2073	ALT I
2074	ALT J
2075	ALT K
2076	ALT L
2077	ALT M
2078	ALT N
2079	ALT O
2080	ALT P
2081	ALT Q
2082	ALT R
2083	ALT S
2084	ALT T
2085	ALT U
2086	ALT V
2087	ALT W
2088	ALT X
2089	ALT Y
2090	ALT Z



Table 8-4. USB GUI Key Character Set

GUI Key	Keystroke
3000	Right Control Key
3048	GUI 0
3049	GUI 1
3050	GUI 2
3051	GUI 3
3052	GUI 4
3053	GUI 5
3054	GUI 6
3055	GUI 7
3056	GUI 8
3057	GUI 9
3065	GUI A
3066	GUI B
3067	GUI C
3068	GUI D
3069	GUI E
3070	GUI F
3071	GUI G
3072	GUI H
3073	GUI I
3074	GUI J
3075	GUI K
3076	GUI L
3077	GUI M
3078	GUI N
3079	GUI O
3080	GUI P
3081	GUI Q
3082	GUI R
3083	GUI S
3084	GUI T
3085	GUI U
3086	GUI V
3087	GUI W

Note: GUI Shift Keys - The Apple™ iMac keyboard has an apple key on either side of the space bar. Windows-based systems have a GUI key to the left of the left ALT key, and to the right of the right ALT key.

Table 8-4. USB GUI Key Character Set (Continued)

GUI Key	Keystroke
3088	GUI X
3089	GUI Y
3090	GUI Z
Note: GUI Shift Keys - The Apple™ iMac keyboard has an apple key on either side of the space bar. Windows-based systems have a GUI key to the left of the left ALT key, and to the right of the right ALT key.	

Table 8-5. USB F Key Character Set

F Keys	Keystroke
5001	F1
5002	F2
5003	F3
5004	F4
5005	F5
5006	F6
5007	F7
5008	F8
5009	F9
5010	F10
5011	F11
5012	F12
5013	F13
5014	F14
5015	F15
5016	F16
5017	F17
5018	F18
5019	F19
5020	F20
5021	F21
5022	F22
5023	F23
5024	F24



Table 8-6. USB Numeric Keypad Character Set

Numeric Keypad	Keystroke
6042	*
6043	+
6044	undefined
6045	-
6046	.
6047	/
6048	0
6049	1
6050	2
6051	3
6052	4
6053	5
6054	6
6055	7
6056	8
6057	9
6058	Enter
6059	Num Lock

Table 8-7. USB Extended Keypad Character Set

Extended Keypad	Keystroke
7001	Break
7002	Delete
7003	PgUp
7004	End
7005	Pg Dn
7006	Pause
7007	Scroll Lock
7008	Backspace
7009	Tab
7010	Print Screen
7011	Insert
7012	Home
7013	Enter
7014	Escape
7015	Up Arrow
7016	Down Arrow
7017	Left Arrow
7018	Right Arrow

9

IBM Interface

Introduction	9-3
Connecting to an IBM 468X/469X Host	9-4
IBM Parameter Defaults	9-5
IBM 468X/469X Host Parameters	9-6
Port Address	9-6
Convert Unknown to Code 39	9-7
Optional IBM Parameters	9-8
Ignore Beep	9-8
Ignore Bar Code Configuration	9-8

Introduction

This chapter provides instructions for programming the cradle to interface with an IBM 468X/469X host computer.

Throughout the programming bar code menus, default values are indicated with asterisks (*).



* Indicates Default — ***Disable Convert to Code** — Feature/Option
39

Connecting to an IBM 468X/469X Host



Note

See [Chapter 4, Radio Communications](#) for information about scanner/cradle pairing and wireless communication.

The scanner must be connected to the cradle for the host parameter setting to take effect. When the scanner is not connected to a cradle, and a host parameter bar code is scanned, a long low/long high beep sequence sounds.

This connection is made directly from the cradle to the host interface.

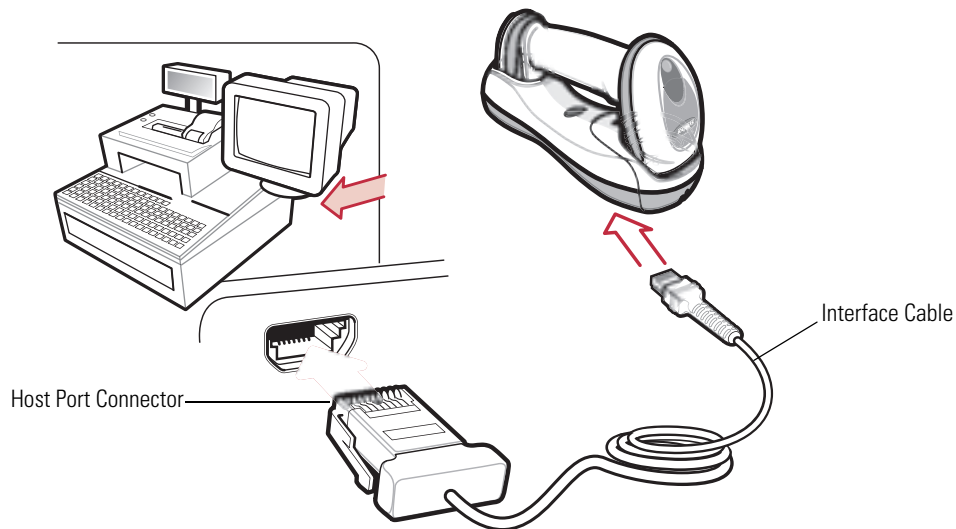

Figure 9-1. IBM Direct Connection

To connect the IBM 46XX interface:

1. Attach the modular connector of the IBM 46XX interface cable to the host port on the bottom of the scanner cradle (see [Connecting the Cradle on page 1-8](#)).
2. Connect the other end of the IBM 46XX interface cable to the appropriate port on the host (typically Port 9).
3. Select the port address by scanning the appropriate bar code from [Port Address on page 9-6](#).
4. To modify any other parameter options, scan the appropriate bar codes in this chapter.



Note

Interface cables vary depending on configuration. The connectors illustrated in [Figure 9-1](#) are examples only. The connectors may be different than those illustrated, but the steps to connect the cradle remain the same.

If a power supply is used, disconnect the power supply before changing host cables or the cradle may not recognize the new host.

The only required configuration is the port number. Other scanner parameters are typically controlled by the IBM system.

IBM Parameter Defaults

Table 9-1 lists the defaults for IBM host parameters. To change any option, scan the appropriate bar code(s) provided in the Parameter Descriptions section beginning on page 9-6.



See [Appendix A, Standard Default Parameters](#) for all user preferences, hosts, symbologies, and miscellaneous default parameters.

Table 9-1. IBM Host Default Table

Parameter	Default	Page Number
IBM 468X/469X Host Parameters		
Port Address	None Selected	9-6
Convert Unknown to Code 39	Disable	9-7

IBM 468X/469X Host Parameters

Port Address

This parameter sets the IBM 468X/469X port used.



Scanning one of these bar codes enables the RS-485 interface on the scanner.



*** None Selected**



Hand-held Scanner Emulation (Port 9B)¹

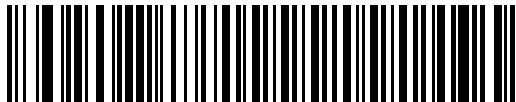

Non-IBM Scanner Emulation (Port 5B)



Table-top Scanner Emulation (Port 17)



¹User selection is required to configure this interface and this is the most common selection.

Convert Unknown to Code 39

Scan a bar code below to enable or disable the conversion of unknown bar code type data to Code 39.

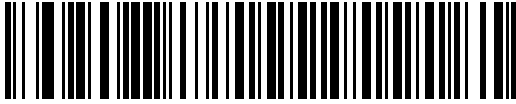

Enable Convert Unknown to Code 39

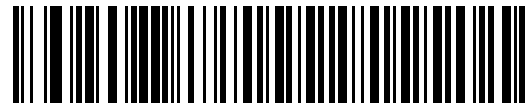

***Disable Convert Unknown to Code 39**

Optional IBM Parameters

If you configure the scanner and find the settings were not saved, or changed, when the system is restarted scan the bar codes that follow to override IBM interface defaults.

Scan a bar code below after setting defaults and before configuring the scanner.

Ignore Beep

The host can send a beep request to the scanner. When this parameter is enabled, the request is not sent to the attached scanner. All directives are still acknowledged to the IBM RS485 host as if it were processed.



Disable



Enable

Ignore Bar Code Configuration

The host has the ability to enable/disable code types. When this parameter is enabled, the request is not sent to the attached scanner. All directives are still acknowledged to the IBM RS485 host as if it were processed.



Disable



Enable

10

Wand Emulation Interface

Introduction	10-3
Connecting Using Wand Emulation	10-4
Wand Emulation Parameter Defaults	10-5
Wand Emulation Host Parameters	10-6
Wand Emulation Host Types	10-6
Leading Margin (Quiet Zone)	10-7
Polarity	10-8
Ignore Unknown Characters	10-8
Convert All Bar Codes to Code 39	10-9
Convert Code 39 to Full ASCII	10-10



Introduction

This chapter provides instructions for programming the cradle to interface with a wand emulation host. This mode is used whenever wand emulation communication is needed. The scanner cradle connects either to an external wand decoder or to a decoder integrated in a portable terminal or Point-of-Sale (POS) terminal.

In this mode the scanner emulates the signal of a digital wand to make it “readable” by a wand decoder.

Throughout the programming bar code menus, default values are indicated with asterisks (*).



* Indicates Default * **Transmit Unknown Characters** Feature/Option

Connecting Using Wand Emulation



See [Chapter 4, Radio Communications](#) for information about scanner/cradle pairing and wireless communication

The scanner must be connected to the cradle for the host parameter setting to take effect. When the scanner is not connected to a cradle, and a host parameter bar code is scanned, a long low/long high beep sequence sounds.

To perform Wand Emulation, connect the cradle to a portable data terminal, or a controller which collects the wand data and interprets it for the host.

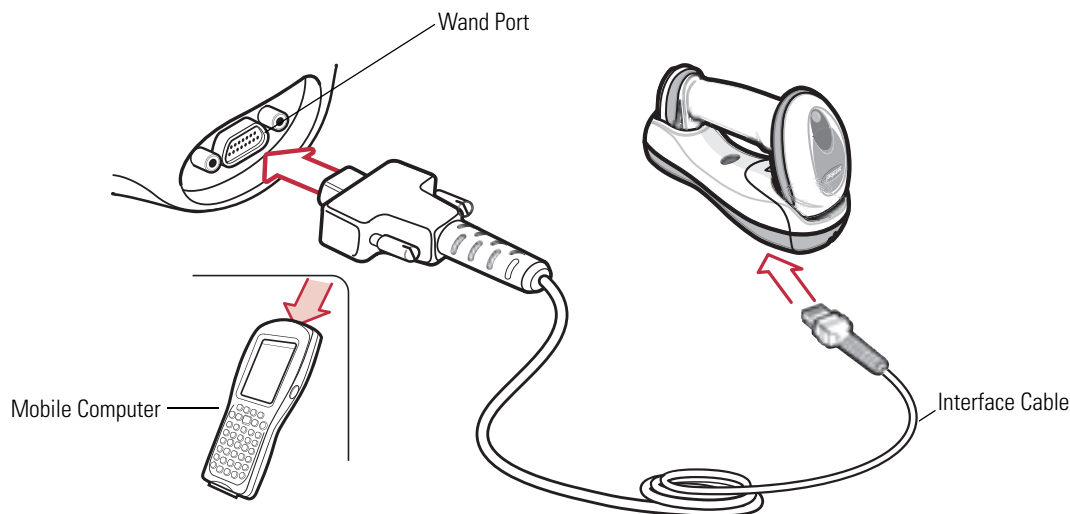
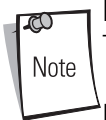

Figure 10-1. Wand Emulation Connection

To connect the Wand Emulation interface:

1. Attach the modular connector of the Wand Emulation interface cable to the host port on the bottom of the scanner cradle (see [Connecting the Cradle on page 1-8](#)).
2. Connect the other end of the Wand Emulation interface cable to the wand port on the mobile computer or controller.
3. Select the Wand Emulation host type by scanning the appropriate bar code from [Wand Emulation Host Types on page 10-6](#).
4. To modify any other parameter options, scan the appropriate bar codes in this chapter.



Interface cables vary depending on configuration. The connectors illustrated in [Figure 10-1](#) are examples only. The connectors may be different than those illustrated, but the steps to connect the cradle remain the same.

If a power supply is used, disconnect the power supply before changing host cables or the cradle may not recognize the new host.



WARNING

Connect the cradle to a 5 volt decoder only. Connecting the cradle to a 12 volt decoder can damage the scanner and invalidate the warranty.

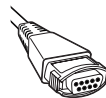

Wand Emulation Parameter Defaults

Table 10-1 lists the defaults for Wand Emulation host types. To change any option, scan the appropriate bar code(s) provided in Wand Emulation Host Parameters beginning on page [page 10-6](#).



See [Appendix A, Standard Default Parameters](#) for all user preferences, hosts, symbologies, and miscellaneous default parameters.

Table 10-1. Wand Emulation Default Table

Parameter	Default	Page Number
Wand Emulation Host Parameters		
Wand Emulation Host Types	Symbol OmniLink Interface Controller ¹	10-6
Leading Margin	80 msec	10-7
Polarity	Bar High/Margin Low	10-8
Ignore Unknown Characters	Send	10-8
Convert All Bar Codes to Code 39	Disable	10-9
Convert Code 39 to Full ASCII	Disable	10-10
¹ User selection is required to configure this interface and this is the most common selection.		

Wand Emulation Host Parameters

Wand Emulation Host Types

Select a Wand Emulation host by scanning one of the bar codes below.

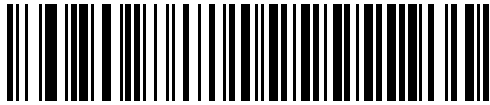

Symbol OmniLink Interface Controller¹



Symbol PDT Terminal (MSI)

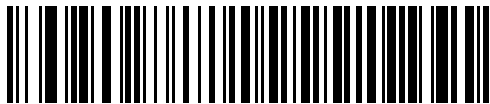

Symbol PTC Terminal (Telxon)



¹User selection is required to configure this interface and this is the most common selection.

Note

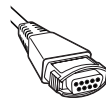

Leading Margin (Quiet Zone)

Scan a bar code below to select a leading margin duration. A leading margin is the time that precedes the first bar of the scan, (in milliseconds). The minimum allowed value is 80 msec and the maximum is 250 msec. This parameter accommodates older wand decoders which cannot handle short leading margins.



250 msec is the maximum value that this parameter can attain, however, 200 msec is sufficient.

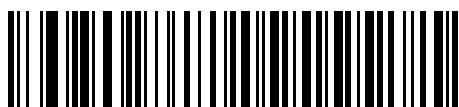

***80 msec**



140 msec

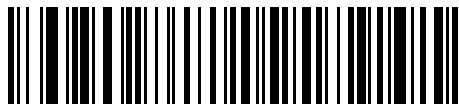

200 msec

Polarity

Scan a bar code below to select the polarity required by the decoder. Polarity determines how the cradle's Wand Emulation interface creates the Digitized Barcode Pattern (DBP). DBP is a digital signal that represents the scanned bar code. Different decoders expect the DBP to be in a certain format. The DBP either has the "highs" represent bars and the "lows" represent spaces (margins), or the "highs" represent spaces (margins) and the "lows" represent bars.

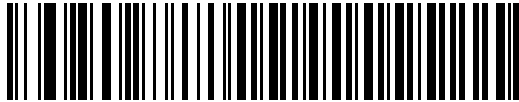

***Bar High/Margin Low**

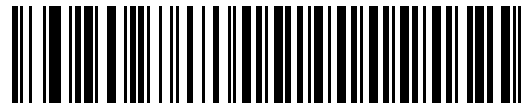

Bar Low/Margin High

Ignore Unknown Characters

Unknown characters are characters the host does not recognize. When **Send Bar Codes With Unknown Characters** is selected, all bar code data is sent except for unknown characters, and no error beeps sound on the scanner. When **Do Not Send Bar Codes With Unknown Characters** is selected, bar codes containing at least one unknown character are not sent to the host, and the scanner emits an error beep.



***Send Bar Codes With Unknown Characters**



Do Not Send Bar Codes With Unknown Characters



Convert All Bar Codes to Code 39

By default, the Wand Emulation interface sends data to the attached host in the same symbology that was decoded. This can be a problem for customers with older systems that do not recognize newer symbologies (for example, RSS).

Enabling this parameter ignores the original symbology decoded, and outputs the data as if it were a Code 39 bar code. Any lowercase characters in the original data stream are transmitted as uppercase characters. This also allows ADF rules.

If **Ignore Unknown Characters** is enabled, any characters that do not have a corresponding character in the Code 39 symbology set are replaced by a space.

If **Ignore Unknown Characters** is disabled, if any characters that do not have a corresponding character are encountered, the scanner emits an error beep and no data is transmitted.

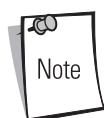

ADF Note: By default, the Wand Emulation interface does not allow scanned data to be processed by ADF rules. Enabling this parameter has the side effect of allowing the scanned data to be processed by the ADF rules (refer to the *Advanced Data Formatting Programming Guide* p/n 72-69680-xx).



Enable Convert to Code 39 for Wand Host

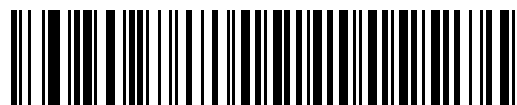

*Disable Convert to Code 39 for Wand Host

Convert Code 39 to Full ASCII

By default, any characters that do not have a corresponding character in the Code 39 symbology set are replaced by a space. If this parameter is enabled, the data sent to the wand interface is encoded in Code 39 Full ASCII. This setting requires that the host be able to interpret Code 39 Full ASCII data.

This setting applies only if **Convert to Code 39** is also enabled.



***Disable Code 39 Full ASCII Conversion**

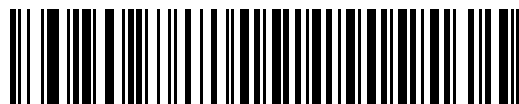

Enable Code 39 Full ASCII Conversion

11

Scanner Emulation Interface

Introduction	11-3
Connecting Using Scanner Emulation	11-4
Scanner Emulation Parameter Defaults	11-5
Scanner Emulation Host	11-6
Scanner Emulation Host Parameters	11-6
Beep Style	11-6
Parameter Pass-Through	11-7
Convert Newer Code Types	11-7
Module Width	11-8
Convert All Bar Codes to Code 39	11-8
Code 39 Full ASCII Conversion	11-8
Transmission Timeout	11-9
Ignore Unknown Characters	11-10
Leading Margin	11-10
Check For Decode LED	11-11

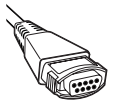

Introduction

This chapter provides instructions for programming the cradle to interface with a scanner emulation host. With scanner emulation, the cradle connects either to an external decoder or to a decoder integrated in a portable terminal or Point-of-Sale (POS) terminal.

Throughout the programming bar code menus, default values are indicated with asterisks (*).



* Indicates Default — ***Parameter Process and** — Feature/Option
Pass-Through

Connecting Using Scanner Emulation



See [Chapter 4, Radio Communications](#) for information about scanner/cradle pairing and wireless communication.

The scanner must be connected to the cradle for the host parameter setting to take effect. When the scanner is not connected to a cradle, and a host parameter bar code is scanned, a long low/long high beep sequence sounds.

To perform Scanner Emulation, connect the cradle to a mobile computer, or a controller which collects the data and interprets it for the host.

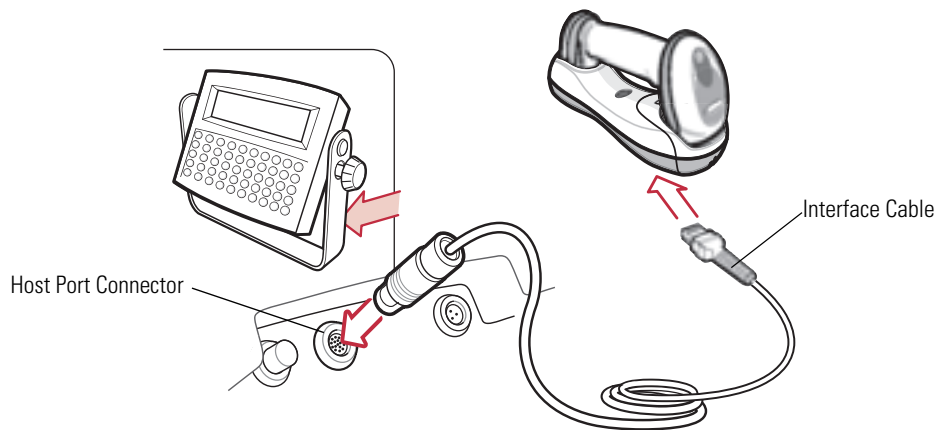
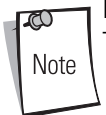

Figure 11-1. Scanner Emulation Connection

To connect the Scanner Emulation interface:

1. Attach the modular connector of the Scanner Emulation interface cable to the host port on the bottom of the scanner cradle (see [Connecting the Cradle on page 1-8](#)).
2. Connect the other end of the Scanner Emulation interface cable to the scanner port on the mobile computer or controller.
3. Scan the Scanner Emulation host bar code from [Scanner Emulation Host on page 11-6](#) to enable the Scanner Emulation host interface.
4. To modify any other parameter options, scan the appropriate bar codes in this chapter.



Interface cables vary depending on configuration. The connectors illustrated in [Figure 11-1](#) are examples only. The connectors may be different than those illustrated, but the steps to connect the cradle remain the same.

If a power supply is used, disconnect the power supply before changing host cables or the cradle may not recognize the new host.



WARNING

Connect the cradle to a 5 volt decoder only. Connecting the cradle to a 12 volt decoder can damage the scanner and invalidate the warranty.

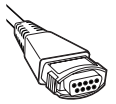

Scanner Emulation Parameter Defaults

Table 11-1 lists the defaults for the Scanner Emulation host. To change any option, scan the appropriate bar code(s) provided in the Scanner Emulation Host Parameters section beginning on page [page 11-6](#).



See [Appendix A, Standard Default Parameters](#) for all user preferences, hosts, symbologies, and miscellaneous default parameters.

Table 11-1. Scanner Emulation Default Table

Parameter	Default	Page Number
Beep Style	Beep on Successful Transmit	11-6
Parameter Pass-Through	Parameter Process and Pass Through	11-7
Convert Newer Code Types	Convert Newer Code Types	11-7
Module Width	20 μ s	11-8
Convert All Bar Codes to Code 39	Do Not Convert Bar Codes to Code 39	11-8
Code 39 Full ASCII Conversion	Disable	11-8
Transmission Timeout	3 sec	11-9
Ignore Unknown Characters	Ignore Unknown Characters	11-10
Leading Margin	2 ms	11-10
Check for Decode LED	Check for Decode LED	11-11

¹User selection is required to configure this interface and this is the most common selection.

Scanner Emulation Host

Scan the bar code below to enable the Scanner Emulation host.



Undecoded Scanner Emulation Host

Scanner Emulation Host Parameters

Beep Style

The Scanner Emulation host supports three beep styles.

- **Beep On Successful Transmit:** The scanner beeps when the attached decoder issues the decode signal to the scanner, so the scanner and the attached decoder beep at the same time.
- **Beep At Decode Time:** The scanner beeps upon decode. This results in a double beep sequence from most decoders, since the scanner beeps, and the decoder beeps (at a different frequency) when it successfully decodes the output.
- **Do Not Beep:** Only the attached decoder issues the decode beep.



***Beep On Successful Transmit**



Beep At Decode Time



Do Not Beep

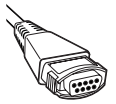

Parameter Pass-Through

The Scanner Emulation host can process parameter bar code messages and send them to the attached decoder. In this way, customers using Symbol compliant decoders can control the behavior of the entire system by scanning the necessary parameters only once.

For example, to enable D 2 of 5, scan the **D 2 of 5 Enable** parameter bar code. The scanner and the attached decoder both process the parameter.



***Parameter Process and Pass-Through**



Parameter Process Only

Convert Newer Code Types

The scanner supports a variety of code types that are not decodable by attached decoder systems. To allow compatibility in these environments, the scanner converts these code types to more commonly decodable symbologies, as per the following chart. Symbologies not listed on this chart are transmitted normally.

Scan this code type:	Transmitted as:
Code 11	Code 39
Chinese 2 of 5	Code 39
RSS (14, Limited, and Expanded)	Code 128
Coupon Code	Code 128

When decoding these code types with this parameter disabled, the scanner issues Convert Error beeps and transmits no data.



***Convert Newer Code Types**



Reject Newer Code Types

Module Width

The standard module width is 20 μ s. For an extremely slow decoder system, select **50 μ s Module Width**.



***20 μ s Module Width**



50 μ s Module Width

Convert All Bar Codes to Code 39

Scan the bar code below to enable or disable the conversion of all bar code data to Code 39.



***Do Not Convert Bar Codes To Code 39**



Convert All To Code 39

Code 39 Full ASCII Conversion

By default, any characters that do not have a corresponding character in the Code 39 symbology set are replaced by a space. If this parameter is enabled, the data sent to the Scanner Emulation host is encoded in Code 39 Full ASCII. The host must be able to interpret Code 39 Full ASCII data. This setting applies only if **Convert to Code 39** is also enabled.



***Disable Convert Code 39 To Full ASCII**



Enable Convert Code 39 To Full ASCII

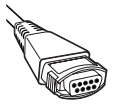

Transmission Timeout

The Scanner Emulation host transmits bar code data to the attached decoder and waits for the decoder to assert the Decode signal, indicating successful transmission. If, after a specified amount of time, the Decode signal is not asserted (indicating that the attached decoder has not successfully received the bar code data), the scanner issues transmit error beeps.

Scan a bar code below to select the desired transmission timeout.



***3 Second Transmission Timeout**



4 Second Transmission Timeout



5 Second Transmission Timeout



10 Second Transmission Timeout



30 Second Transmission Timeout

Ignore Unknown Characters

Unknown characters are characters the decoder does not recognize. When **Ignore Unknown Characters** is selected, all bar code data is sent except for unknown characters, and no error beeps sound. When **Convert Error on Unknown Characters** is selected, bar codes containing at least one unknown character are not sent to the decoder, and a convert error beep sounds.



***Ignore Unknown Characters**



Convert Error On Unknown Characters

Leading Margin

Scan a bar code below to select a leading margin duration.



1 ms Leading Margin



***2 ms Leading Margin**



3 ms Leading Margin

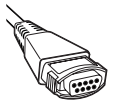

Leading Margin (continued)



5 ms Leading Margin



10 ms Leading Margin

Check For Decode LED

The attached decoder normally asserts the Decode line to signal to the Scanner Emulation host that it successfully decoded the transmitted bar code. Some decoders, however, do not assert the Decode signal. In this case, the scanner emits transmit error beeps to indicate that the bar code was not successfully transmitted. Scan the **Ignore Decode LED** bar code to disable the Transmit Error beeps.



***Check For Decode LED**



Ignore Decode LED

12

123Scan

Introduction	12-3
Communication with 123Scan	12-3
123Scan requirements:	12-3
123Scan Parameter	12-3

Introduction

123Scan is a Windows[®]-based utility that programs the scanner with all parameters including ADF rules. An ADF rule modifies bar code data before it is sent to the host to ensure compatibility between bar coded data and the host application. Scanners can be programmed via PC download or by scanning a sheet of bar codes generated by the utility. Scanner programming is saved in a file for electronic distribution. The 123Scan program includes a help file.



Note

See [Chapter 4, Radio Communications](#) for information about scanner/cradle pairing and wireless communication

The scanner must be connected to the cradle for the host parameter setting to take effect. When the scanner is not connected to a cradle, and a host parameter bar code is scanned, a long low/long high beep sequence sounds.

Communication with 123Scan

To communicate with the 123Scan program which runs on a host computer running a Windows operating system, use an RS-232 cable to connect the scanner cradle to the host computer (see [Connecting an RS-232 Interface on page 7-4](#)).

123Scan requirements:

- Host computer with Windows 98, Windows NT, Windows 2000, or Windows XP
- Scanner
- Cradle
- RS-232 cable.

123Scan Parameter

To communicate with the 123Scan program, load 123Scan, included in the documentation CD-ROM, onto the host computer, and scan the bar code below. Refer to 123Scan instructions for programming the scanner.

Scan the bar code below to enable the 123Scan interface on the scanner.

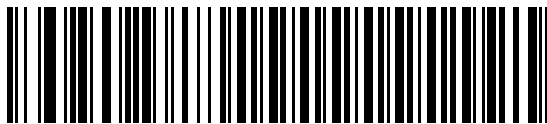

123Scan Configuration

13

Symbologies

Introduction	13-5
Scanning Sequence Examples	13-5
Errors While Scanning	13-5
Symbology Parameter Defaults	13-6
UPC/EAN	13-9
Enable/Disable UPC-A/UPC-E	13-9
Enable/Disable UPC-E1	13-10
Enable/Disable EAN-13/EAN-8	13-10
Enable/Disable Bookland EAN	13-11
Decode UPC/EAN/JAN Supplementals	13-11
UPC/EAN/JAN Supplemental Redundancy	13-13
Transmit UPC-A Check Digit	13-13
Transmit UPC-E Check Digit	13-13
Transmit UPC-E1 Check Digit	13-14
UPC-A Preamble	13-14
UPC-E Preamble	13-15
UPC-E1 Preamble	13-16
Convert UPC-E to UPC-A	13-16
Convert UPC-E1 to UPC-A	13-17
EAN-8/JAN-8 Extend	13-17
UCC Coupon Extended Code	13-18
Code 128	13-19
Enable/Disable Code 128	13-19
Enable/Disable UCC/EAN-128	13-19
Enable/Disable ISBT 128	13-20
Code 39	13-21

Enable/Disable Code 39	13-21
Enable/Disable Trioptic Code 39	13-21
Convert Code 39 to Code 32	13-22
Code 32 Prefix	13-22
Set Lengths for Code 39	13-23
Code 39 Check Digit Verification	13-24
Transmit Code 39 Check Digit	13-24
Code 39 Full ASCII Conversion	13-25
Code 39 Buffering (Scan & Store)	13-25
Buffer Data	13-26
Clear Transmission Buffer	13-27
Transmit Buffer	13-27
Overfilling Transmission Buffer	13-28
Attempt to Transmit an Empty Buffer	13-28
Code 93	13-29
Enable/Disable Code 93	13-29
Set Lengths for Code 93	13-29
Code 11	13-31
Code 11	13-31
Set Lengths for Code 11	13-31
Code 11 Check Digit Verification	13-33
Transmit Code 11 Check Digits	13-33
Interleaved 2 of 5 (ITF)	13-34
Enable/Disable Interleaved 2 of 5	13-34
Set Lengths for Interleaved 2 of 5	13-34
I 2 of 5 Check Digit Verification	13-35
Transmit I 2 of 5 Check Digit	13-36
Convert I 2 of 5 to EAN-13	13-36
Discrete 2 of 5 (DTF)	13-37
Enable/Disable Discrete 2 of 5	13-37
Set Lengths for Discrete 2 of 5	13-37
Chinese 2 of 5	13-39
Enable/Disable Chinese 2 of 5	13-39
Codabar (NW - 7)	13-40
Enable/Disable Codabar	13-40
Set Lengths for Codabar	13-40
CLSI Editing	13-41
NOTIS Editing	13-42
MSI	13-43
Enable/Disable MSI	13-43
Set Lengths for MSI	13-43
MSI Check Digits	13-44
Transmit MSI Check Digit(s)	13-45
MSI Check Digit Algorithm	13-45
RSS (Reduced Space Symbology)	13-46
Convert RSS to UPC/EAN	13-47
Symbology - Specific Security Levels	13-48
Redundancy Level	13-48

Redundancy Level 1 13-48
Redundancy Level 2 13-48
Redundancy Level 3 13-48
Redundancy Level 4 13-48
Security Level 13-50
 Bi-directional Redundancy 13-51
Symbology - Intercharacter Gap 13-52

Introduction

This chapter describes symbology features and provides the programming bar codes for selecting these features. Before programming, follow the instructions in [Chapter 1, Getting Started](#).

The scanner is shipped with the settings shown in the [Symbology Parameter Defaults on page 13-6](#) (also see [Appendix A, Standard Default Parameters](#) for all host device and miscellaneous defaults). If the default values suit requirements, programming is not necessary.

To set feature values, scan a single bar code or a short bar code sequence. The settings are stored in non-volatile memory and are preserved even when the scanner is powered down.

If not using a Synapse or USB cable, select a host type (see each host chapter for specific host information) after the power-up beeps sound. This is only necessary upon the first power-up when connected to a new host.

To return all features to default values, scan the appropriate default bar code on [page 5-5](#). Throughout the programming bar code menus, default values are indicated with asterisks (*).



* Indicates Default ——— *Enable UPC-A ——— Feature/Option

Scanning Sequence Examples

In most cases, scanning one bar code sets the parameter value. For example, to transmit bar code data without the UPC-A check digit, simply scan the **Do Not Transmit UPC-A Check Digit** bar code under [Transmit UPC-A Check Digit on page 13-13](#). The scanner issues a fast warble beep and the LED turns green, signifying a successful parameter entry.

Other parameters, such as **Set Length(s) for D 2 of 5**, require scanning several bar codes. See the individual parameter, such as **Set Length(s) for D 2 of 5**, for this procedure.

Errors While Scanning

Unless otherwise specified, to correct an error during a scanning sequence, just re-scan the correct parameter.

Symbology Parameter Defaults

Table 13-1 lists the defaults for all symbologies parameters. To change any option, scan the appropriate bar code(s) provided in the Symbologies Parameters section beginning on 13-9.



See [Appendix A, Standard Default Parameters](#) for all user preferences, hosts, symbologies and miscellaneous default parameters.

Table 13-1. Symbology Parameter Defaults

Parameter	Default	Page Number
UPC/EAN		
UPC-A	Enable	13-9
UPC-E	Enable	13-9
UPC-E1	Disable	13-10
EAN-8/JAN 8	Enable	13-10
EAN-13/JAN 13	Enable	13-10
Bookland EAN	Disable	13-11
Decode UPC/EAN/JAN Supplementals (2 and 5 digits)	Ignore	13-12
Decode UPC/EAN/JAN Supplemental Redundancy	7	13-11
Transmit UPC-A Check Digit	Enable	13-13
Transmit UPC-E Check Digit	Enable	13-13
Transmit UPC-E1 Check Digit	Enable	13-14
UPC-A Preamble	System Character	13-14
UPC-E Preamble	System Character	13-14
UPC-E1 Preamble	System Character	13-16
Convert UPC-E to A	Disable	13-16
Convert UPC-E1 to A	Disable	13-17
EAN-8/JAN-8 Extend	Disable	13-17
UCC Coupon Extended Code	Disable	13-18
Code 128		
Code 128	Enable	13-19
UCC/EAN-128	Enable	13-19
ISBT 128 (non-concatenated)	Enable	13-20
Code 39		
Code 39	Enable	13-21
Trioptic Code 39	Disable	13-21
Convert Code 39 to Code 32 (Italian Pharmacy Code)	Disable	13-22
Code 32 Prefix	Disable	13-22
Set Length(s) for Code 39	2 to 55	13-23

Table 13-1. Symbology Parameter Defaults (Continued)

Parameter	Default	Page Number
Code 39 Check Digit Verification	Disable	13-24
Transmit Code 39 Check Digit	Disable	13-24
Code 39 Full ASCII Conversion	Disable	13-25
Buffer Code 39	Disable	13-25
Code 93		
Code 93	Disable	13-29
Set Length(s) for Code 93	4 to 55	13-29
Code 11		
Code 11	Disable	13-31
Set Lengths for Code 11	4 to 55	13-31
Code 11 Check Digit Verification	Disable	13-33
Transmit Code 11 Check Digit(s)	Disable	13-33
Interleaved 2 of 5 (ITF)		
Interleaved 2 of 5 (ITF)	Enable	13-34
Set Lengths for I 2 of 5	14	13-34
I 2 of 5 Check Digit Verification	Disable	13-35
Transmit I 2 of 5 Check Digit	Disable	13-36
Convert I 2 of 5 to EAN 13	Disable	13-36
Discrete 2 of 5 (DTF)		
Discrete 2 of 5	Disable	13-37
Set Length(s) for D 2 of 5	12	13-37
Chinese 2 of 5		
Enable/Disable Chinese 2 of 5	Disable	13-39
Codabar (NW - 7)		
Codabar	Disable	13-40
Set Lengths for Codabar	5 to 55	13-40
CLSI Editing	Disable	13-41
NOTIS Editing	Disable	13-42
MSI		
MSI	Disable	13-43
Set Length(s) for MSI	2 to 55	13-43
MSI Check Digits	One	13-44
Transmit MSI Check Digit	Disable	13-45
MSI Check Digit Algorithm	Mod 10/Mod 10	13-45

Table 13-1. Symbology Parameter Defaults (Continued)

Parameter	Default	Page Number
RSS (Reduced Space Symbology)		
RSS 14	Disable	13-46
RSS Limited	Disable	13-46
RSS Expanded	Disable	13-46
Convert RSS to UPC/EAN	Disable	13-47
Symbology - Specific Security Levels		
Redundancy Level	1	13-48
Security Levels	0	13-50
Bi-directional Redundancy	Disable	13-51

UPC/EAN

Enable/Disable UPC-A/UPC-E

To enable or disable UPC-A or UPC-E, scan the appropriate bar code below.



***Enable UPC-A**



Disable UPC-A

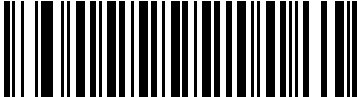

***Enable UPC-E**



Disable UPC-E

Enable/Disable UPC-E1

UPC-E1 is disabled by default.

To enable or disable UPC-E1, scan the appropriate bar code below.



UPC-E1 is not a UCC (Uniform Code Council) approved symbology.

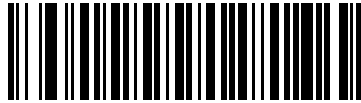

Enable UPC-E1

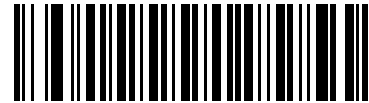

***Disable UPC-E1**

Enable/Disable EAN-13/EAN-8

To enable or disable EAN-13 or EAN-8, scan the appropriate bar code below.



***Enable EAN-13**



Disable EAN-13



***Enable EAN-8**

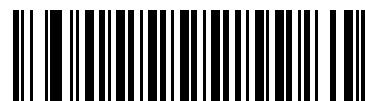

Disable EAN-8

Enable/Disable Bookland EAN

To enable or disable Bookland EAN, scan the appropriate bar code below.

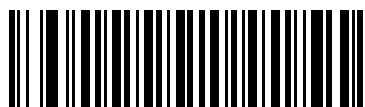

Enable Bookland EAN

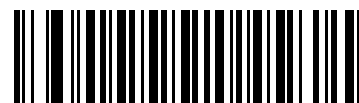

*Disable Bookland EAN

Decode UPC/EAN/JAN Supplementals

Supplementals are bar codes appended according to specific format conventions (e.g., UPC A+2, UPC E+2, EAN 13+2). Six options are available.

- If **Decode UPC/EAN/JAN Only With Supplementals** is selected, UPC/EAN symbols without supplementals are not decoded.
- If **Ignore Supplementals** is selected, and the scanner is presented with a UPC/EAN/JAN with a supplemental, the UPC/EAN/JAN is decoded and the supplemental bar code is ignored.
- An **Autodiscriminate Option** is also available. If this option is selected, choose an appropriate [UPC/EAN/JAN Supplemental Redundancy](#) value from the next page. A value of 5 or more is recommended.
- Select **Enable 378/379 Supplemental Mode** to delay only EAN-13/JAN-13 bar codes starting with a '378' or '379' prefix by the supplemental search process. All other UPC/EAN/JAN bar codes are exempted from the search and are reported instantly upon decode.
- Select **Enable 978 Supplemental Mode** to delay only EAN-13/JAN-13 bar codes starting with a '978' prefix by the supplemental search process. All other UPC/EAN bar codes are exempted from the search and are reported instantly upon their decode.
- Select **Enable Smart Supplemental Mode** to delay only EAN-13/JAN-13 bar codes starting with a '378', '379', or '978' prefix by the supplemental search process. All other UPC/EAN bar codes are exempted from the search and are reported instantly upon their decode.



Note

To minimize the risk of invalid data transmission, select either to decode or ignore supplemental characters.

Decode UPC/EAN/JAN Supplementals (continued)



Decode UPC/EAN/JAN Only With Supplementals



***Ignore Supplementals**



Autodiscriminate UPC/EAN/JAN Supplementals



Enable 378/379 Supplemental Mode



Enable 978 Supplemental Mode



Enable Smart Supplemental Mode

UPC/EAN/JAN Supplemental Redundancy

With **Autodiscriminate UPC/EAN/JAN Supplementals** selected, this option adjusts the number of times a symbol without supplementals is decoded before transmission. The range is from two to thirty times. Five or above is recommended when decoding a mix of UPC/EAN symbols with and without supplementals, and the autodiscriminate option is selected. The default is set at 7.

Scan the bar code below to set a decode redundancy value. Next, scan two numeric bar codes in [Appendix D, Numeric Bar Codes](#). Single digit numbers must have a leading zero. To correct an error or change a selection, scan **Cancel** on page [D-4](#).



UPC/EAN/JAN Supplemental Redundancy

Transmit UPC-A Check Digit

The check digit is the last character of the symbol used to verify the integrity of the data. Scan the appropriate bar code below to transmit the bar code data with or without the UPC-A check digit. It is always verified to guarantee the integrity of the data.



***Transmit UPC-A Check Digit**

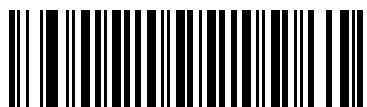

Do Not Transmit UPC-A Check Digit

Transmit UPC-E Check Digit

The check digit is the last character of the symbol used to verify the integrity of the data. Scan the appropriate bar code below to transmit the bar code data with or without the UPC-E check digit. It is always verified to guarantee the integrity of the data.

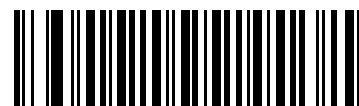

***Transmit UPC-E Check Digit**

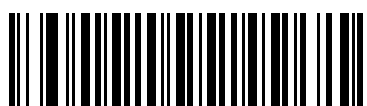

Do Not Transmit UPC-E Check Digit

Transmit UPC-E1 Check Digit

The check digit is the last character of the symbol used to verify the integrity of the data. Scan the appropriate bar code below to transmit the bar code data with or without the UPC-E1 check digit. It is always verified to guarantee the integrity of the data.

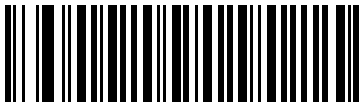

***Transmit UPC-E1 Check Digit**



Do Not Transmit UPC-E1 Check Digit

UPC-A Preamble

Preamble characters are part of the UPC symbol consisting of Country Code and System Character. Three options are given for transmitting UPC-A preamble to the host device: transmit System Character only, transmit System Character and Country Code ("0" for USA), and no preamble transmitted. Scan a bar code below to match the host system.

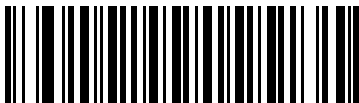

**No Preamble
<DATA>**



***System Character
<SYSTEM CHARACTER> <DATA>**

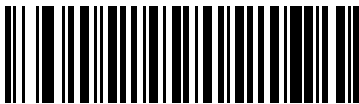

**System Character & Country Code
< COUNTRY CODE> <SYSTEM CHARACTER> <DATA>**

UPC-E Preamble

Preamble characters are part of the UPC symbol consisting of Country Code and System Character. Three options are given for transmitting UPC-E preamble to the host device: transmit System Character only, transmit System Character and Country Code ("0" for USA), and no preamble transmitted. Scan a bar code below to match the host system.

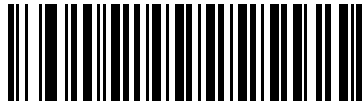

No Preamble
(<DATA>)

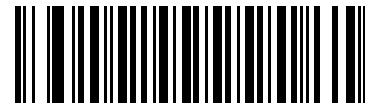

***System Character**
(<SYSTEM CHARACTER> <DATA>)

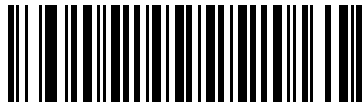

System Character & Country Code
(< COUNTRY CODE> <SYSTEM CHARACTER> <DATA>)

UPC-E1 Preamble

Preamble characters are part of the UPC symbol consisting of Country Code and System Character. Three options are given for transmitting UPC-E1 preamble to the host device: transmit System Character only, transmit System Character and Country Code ("0" for USA), and no preamble transmitted. Scan a bar code below to match the host system.

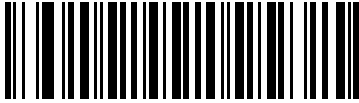

No Preamble
(<DATA>)

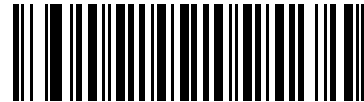

***System Character**
(<SYSTEM CHARACTER> <DATA>)

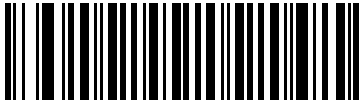

System Character & Country Code
(< COUNTRY CODE> <SYSTEM CHARACTER> <DATA>)

Convert UPC-E to UPC-A

Enable this to convert UPC-E (zero suppressed) decoded data to UPC-A format before transmission. After conversion, the data follows UPC-A format and is affected by UPC-A programming selections (e.g., Preamble, Check Digit).

When disabled, UPC-E decoded data is transmitted as UPC-E data, without conversion.



Convert UPC-E to UPC-A
(Enable)

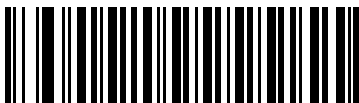

***Do Not Convert UPC-E to UPC-A**
(Disable)

Convert UPC-E1 to UPC-A

Enable this to convert UPC-E1 decoded data to UPC-A format before transmission. After conversion, the data follows UPC-A format and is affected by UPC-A programming selections (e.g., Preamble, Check Digit).

When disabled, UPC-E1 decoded data is transmitted as UPC-E1 data, without conversion.

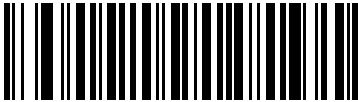

**Convert UPC-E1 to UPC-A
(Enable)**

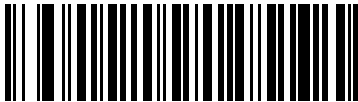

***Do Not Convert UPC-E1 to UPC-A
(Disable)**

EAN-8/JAN-8 Extend

When enabled, this parameter adds five leading zeros to decoded EAN-8 symbols to make them compatible in format to EAN-13 symbols.

When disabled, EAN-8 symbols are transmitted as is.

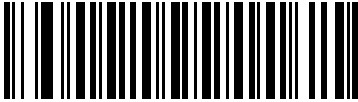

Enable EAN/JAN Zero Extend

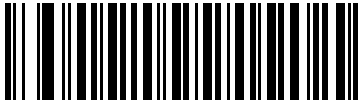

***Disable EAN/JAN Zero Extend**

UCC Coupon Extended Code

When enabled, this parameter decodes UPCA bar codes starting with digit '5', EAN-13 bar codes starting with digit '99', and UPCA/EAN-128 Coupon Codes. UPCA, EAN-13 and EAN-128 must be enabled to scan all types of Coupon Codes.

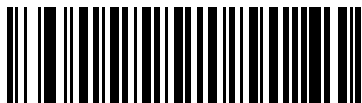

Enable UCC Coupon Extended Code



***Disable UCC Coupon Extended Code**



Use the *Decode UPC/EAN Supplemental Redundancy* parameter to control autodiscrimination of the EAN128 (right half) of a coupon code.

Code 128

Enable/Disable Code 128

To enable or disable Code 128, scan the appropriate bar code below.

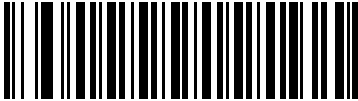

***Enable Code 128**

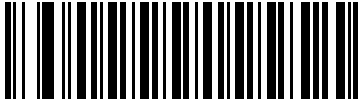

Disable Code 128

Enable/Disable UCC/EAN-128

To enable or disable UCC/EAN-128, scan the appropriate bar code below.

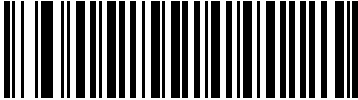

***Enable UCC/EAN-128**

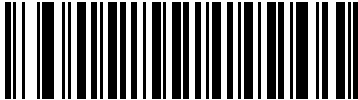

Disable UCC/EAN-128

Enable/Disable ISBT 128

ISBT 128 is a variant of Code 128 used in the blood bank industry. Scan the appropriate bar code below to enable or disable ISBT 128. If necessary, the host must perform concatenation of the ISBT data.

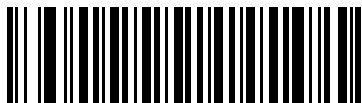

***Enable ISBT 128**



Disable ISBT 128

Code 39

Enable/Disable Code 39

To enable or disable Code 39, scan the appropriate bar code below.

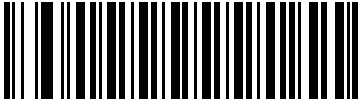

***Enable Code 39**

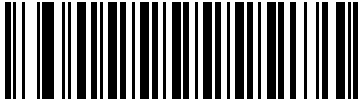

Disable Code 39

Enable/Disable Trioptic Code 39

Trioptic Code 39 is a variant of Code 39 used in the marking of computer tape cartridges. Trioptic Code 39 symbols always contain six characters. To enable or disable Trioptic Code 39, scan the appropriate bar code below.

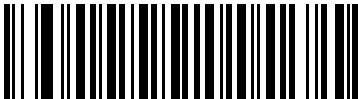

Enable Trioptic Code 39

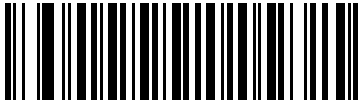

***Disable Trioptic Code 39**



Trioptic Code 39 and Code 39 Full ASCII cannot be enabled simultaneously.

Note

Convert Code 39 to Code 32

Code 32 is a variant of Code 39 used by the Italian pharmaceutical industry. Scan the appropriate bar code below to enable or disable converting Code 39 to Code 32.



Code 39 must be enabled for this parameter to function.



Enable Convert Code 39 to Code 32

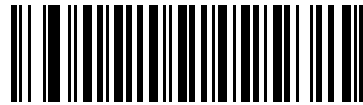

***Disable Convert Code 39 to Code 32**

Code 32 Prefix

Scan the appropriate bar code below to enable or disable adding the prefix character "A" to all Code 32 bar codes.



Convert Code 39 to Code 32 must be enabled for this parameter to function.

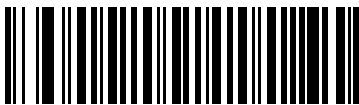

Enable Code 32 Prefix

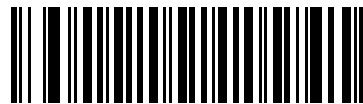

***Disable Code 32 Prefix**

Set Lengths for Code 39

The length of a code refers to the number of characters (i.e., human readable characters), including check digit(s) the code contains. Set lengths for Code 39 to any length, one or two discrete lengths, or lengths within a specific range. If Code 39 Full ASCII is enabled, **Length Within a Range** or **Any Length** are the preferred options.



When setting lengths for different bar code types by scanning single digit numbers, single digit numbers must always be preceded by a leading zero.

- **One Discrete Length** - Select this option to decode only Code 39 symbols containing a selected length. Select the length using the numeric bar codes in [Appendix D, Numeric Bar Codes](#). For example, to decode only Code 39 symbols with 14 characters, scan **Code 39 - One Discrete Length**, then scan **1** followed by **4**. To correct an error or change the selection, scan **Cancel** on page [D-4](#).
- **Two Discrete Lengths** - Select this option to decode only Code 39 symbols containing either of two selected lengths. Select lengths using the numeric bar codes in [Appendix D, Numeric Bar Codes](#). For example, to decode only those Code 39 symbols containing either 2 or 14 characters, select **Code 39 - Two Discrete Lengths**, then scan **0, 2, 1**, and then **4**. To correct an error or change the selection, scan **Cancel** on page [D-4](#).
- **Length Within Range** - Select this option to decode a Code 39 symbol with a specific length range. Select lengths using numeric bar codes in [Appendix D, Numeric Bar Codes](#). For example, to decode Code 39 symbols containing between 4 and 12 characters, first scan **Code 39 - Length Within Range**. Then scan **0, 4, 1**, and **2** (single digit numbers must always be preceded by a leading zero). To correct an error or change the selection, scan **Cancel** on page [D-4](#).
- **Any Length** - Select this option to decode Code 39 symbols containing any number of characters within the scanner capability.



Code 39 - One Discrete Length



Code 39 - Two Discrete Lengths



Code 39 - Length Within Range



Code 39 - Any Length

Code 39 Check Digit Verification

When this feature is enabled, the scanner checks the integrity of all Code 39 symbols to verify that the data complies with specified check digit algorithm. Only Code 39 symbols which include a modulo 43 check digit are decoded. Enable this feature if the Code 39 symbols contain a Modulo 43 check digit.

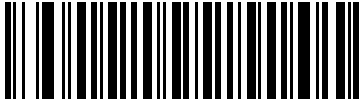

Enable Code 39 Check Digit

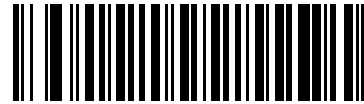

***Disable Code 39 Check Digit**

Transmit Code 39 Check Digit

Scan the appropriate bar code below to transmit Code 39 data with or without the check digit.

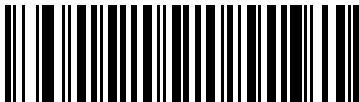

**Transmit Code 39 Check Digit
(Enable)**



***Do Not Transmit Code 39 Check Digit
(Disable)**



Code 39 Check Digit Verification must be enabled for this parameter to function.

Note

Code 39 Full ASCII Conversion

Code 39 Full ASCII is a variant of Code 39 which pairs characters to encode the full ASCII character set. To enable or disable Code 39 Full ASCII, scan the appropriate bar code below.

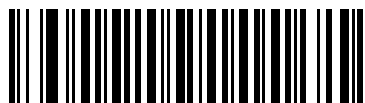

Enable Code 39 Full ASCII



***Disable Code 39 Full ASCII**



Trioptic Code 39 and Code 39 Full ASCII cannot be enabled simultaneously.

Note

Code 39 Full ASCII to Full ASCII Correlation is host-dependent and is described in the ASCII Character Set table for the appropriate interface. See [Keyboard Wedge ASCII Character Set on page 6-14](#), [ASCII Character Set for RS-232 on page 7-19](#) and [ASCII Character Set for USB on page 8-14](#) for the appropriate interface.

Code 39 Buffering (Scan & Store)

This feature allows the scanner to accumulate data from multiple Code 39 symbols.

Selecting the Scan and Store option (Buffer Code 39) temporarily buffers all Code 39 symbols having a leading space as a first character for later transmission. The leading space is not buffered.

Decode of a valid Code 39 symbol with no leading space causes transmission in sequence of all buffered data in a first-in first-out format, plus transmission of the “triggering” symbol. See the following pages for further details.

When the **Do Not Buffer Code 39** option is selected, all decoded Code 39 symbols are transmitted immediately without being stored in the buffer.

This feature affects Code 39 only. If selecting **Buffer Code 39**, we recommend configuring the scanner to decode Code 39 symbology only.



**Buffer Code 39
(Enable)**

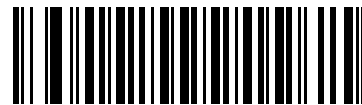

***Do Not Buffer Code 39
(Disable)**

While there is data in the transmission buffer, selecting **Do Not Buffer Code 39** is not allowed. The buffer holds 200 bytes of information.

To disable Code 39 buffering when there is data in the transmission buffer, first force the buffer transmission (see [Transmit Buffer on page 13-27](#)) or clear the buffer.

Buffer Data

To buffer data, Code 39 buffering must be enabled and a Code 39 symbol must be read with a space immediately following the start pattern.

- Unless the data overflows the transmission buffer, the scanner issues a low/high beep to indicate successful decode and buffering. (For overflow conditions, see [Overfilling Transmission Buffer](#).)
- The scanner adds the decoded data excluding the leading space to the transmission buffer.
- No transmission occurs.

Clear Transmission Buffer

To clear the transmission buffer, scan the **Clear Buffer** bar code below, which contains only a start character, a dash (minus), and a stop character.

- The scanner issues a short high/low/high beep.
- The scanner erases the transmission buffer.
- No transmission occurs.



Clear Buffer



Because the Clear Buffer contains only the dash (minus) character, set the Code 39 length to include length 1 before scanning this bar code.

Transmit Buffer

There are two methods to transmit the Code 39 buffer.

1. Scan the **Transmit Buffer** bar code below which contains only a start character, a plus (+), and a stop character.
 - The scanner transmits and clears the buffer.
 - The scanner issues a low/high beep.



Transmit Buffer

2. Scan a Code 39 bar code with a leading character other than a space.
 - The scanner appends new decode data to buffered data.
 - The scanner transmits and clears the buffer.
 - The scanner signals that the buffer was transmitted with a low/high beep.
 - Scanner transmits and clears the buffer.



Because the Transmit Buffer contains only a plus (+) character, set the Code 39 length to include length 1 before scanning this bar code.

Overfilling Transmission Buffer

The Code 39 buffer holds 200 characters. If the symbol just read results in an overflow of the transmission buffer:

- The scanner indicates that the symbol was rejected by issuing three long, high beeps.
- No transmission occurs. The data in the buffer is not affected.

Attempt to Transmit an Empty Buffer

If the symbol just read was the **Transmit Buffer** symbol and the Code 39 buffer is empty:

- A short low/high/low beep signals that the buffer is empty.
- No transmission occurs.
- The buffer remains empty.

Code 93

Enable/Disable Code 93

To enable or disable Code 93, scan the appropriate bar code below.



Enable Code 93

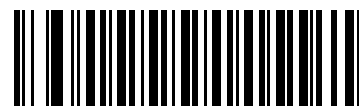

***Disable Code 93**

Set Lengths for Code 93

The length of a code refers to the number of characters (i.e., human readable characters), including check digit(s) the code contains. Set lengths for Code 93 to any length, one or two discrete lengths, or lengths within a specific range.

- **One Discrete Length** - Select this option to decode only Code 93 symbols containing a selected length. Select the length using the numeric bar codes in [Appendix D, Numeric Bar Codes](#). For example, to decode only Code 93 symbols with 14 characters, scan **Code 93 - One Discrete Length**, then scan **1** followed by **4**. To correct an error or to change the selection, scan **Cancel** on page [D-4](#).
- **Two Discrete Lengths** - Select this option to decode only Code 93 symbols containing either of two selected lengths. Select lengths using the numeric bar codes in [Appendix D, Numeric Bar Codes](#). For example, to decode only those Code 93 symbols containing either 2 or 14 characters, select **Code 93 - Two Discrete Lengths**, then scan **0, 2, 1**, and then **4**. To correct an error or to change the selection, scan **Cancel** on page [D-4](#).
- **Length Within Range** - Select this option to decode a Code 93 symbol with a specific length range. Select lengths using the numeric bar codes in [Appendix D, Numeric Bar Codes](#). For example, to decode Code 93 symbols containing between 4 and 12 characters, first scan **Code 93 - Length Within Range**. Then scan **0, 4, 1**, and **2** (single digit numbers must always be preceded by a leading zero). To correct an error or change the selection, scan **Cancel** on page [D-4](#).
- **Any Length** - Scan this option to decode Code 93 symbols containing any number of characters within the scanner's capability.

Set Lengths for Code 93 (continued)



Code 93 - One Discrete Length



Code 93 - Two Discrete Lengths



Code 93 - Length Within Range



Code 93 - Any Length

Code 11

Code 11

To enable or disable Code 11, scan the appropriate bar code below.



Enable Code 11

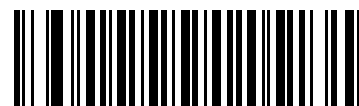

***Disable Code 11**

Set Lengths for Code 11

The length of a code refers to the number of characters (i.e., human readable characters), including check digit(s) the code contains. Set lengths for Code 11 to any length, one or two discrete lengths, or lengths within a specific range.

- **One Discrete Length** - Select this option to decode only Code 11 symbols containing a selected length. Select the length using the numeric bar codes in [Appendix D, Numeric Bar Codes](#). For example, to decode only Code 11 symbols with 14 characters, scan **Code 11 - One Discrete Length**, then scan **1** followed by **4**. To correct an error or to change the selection, scan **Cancel** on page [D-4](#).
- **Two Discrete Lengths** - Select this option to decode only Code 11 symbols containing either of two selected lengths. Select lengths using the numeric bar codes in [Appendix D, Numeric Bar Codes](#). For example, to decode only those Code 11 symbols containing either 2 or 14 characters, select **Code 11 - Two Discrete Lengths**, then scan **0, 2, 1**, and then **4**. To correct an error or to change the selection, scan **Cancel** on page [D-4](#).
- **Length Within Range** - Select this option to decode a Code 11 symbol with a specific length range. Select lengths using numeric bar codes in [Appendix D, Numeric Bar Codes](#). For example, to decode Code 11 symbols containing between 4 and 12 characters, first scan **Code 11 - Length Within Range**. Then scan **0, 4, 1**, and **2** (single digit numbers must always be preceded by a leading zero). To correct an error or change the selection, scan **Cancel** on page [D-4](#).
- **Any Length** - Scan this option to decode Code 11 symbols containing any number of characters within the scanner capability.

Set Lengths for Code 11 (continued)



Code 11 - One Discrete Length

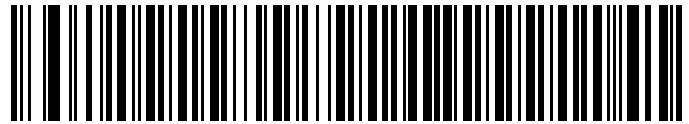

Code 11 - Two Discrete Lengths



Code 11 - Length Within Range

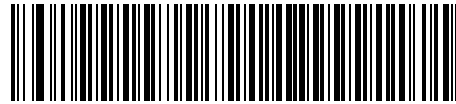

Code 11 - Any Length

Code 11 Check Digit Verification

This feature allows the scanner to check the integrity of all Code 11 symbols to verify that the data complies with the specified check digit algorithm. This selects the check digit mechanism for the decoded Code 11 bar code. The options are to check for one check digit, check for two check digits, or disable the feature.

To enable this feature, scan the bar code below corresponding to the number of check digits encoded in your Code 11 symbols.



***Disable**

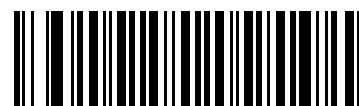

One Check Digit



Two Check Digits

Transmit Code 11 Check Digits

This feature selects whether or not to transmit the Code 11 check digit(s).



**Transmit Code 11 Check Digit(s)
(Enable)**

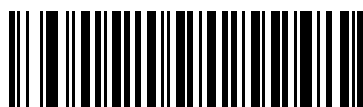

***Do Not Transmit Code 11 Check Digit(s)
(Disable)**



Code 11 Check Digit Verification must be enabled for this parameter to function.

Interleaved 2 of 5 (ITF)

Enable/Disable Interleaved 2 of 5

To enable or disable Interleaved 2 of 5, scan the appropriate bar code below, and select an Interleaved 2 of 5 length from the following pages.



*Enable Interleaved 2 of 5



Disable Interleaved 2 of 5

Set Lengths for Interleaved 2 of 5

The length of a code refers to the number of characters (i.e., human readable characters), including check digit(s) the code contains. Set lengths for I 2 of 5 to any length, one or two discrete lengths, or lengths within a specific range.

- **One Discrete Length** - Select this option to decode only I 2 of 5 symbols containing a selected length. Select the length using the numeric bar codes in [Appendix D, Numeric Bar Codes](#). For example, to decode only I 2 of 5 symbols with 14 characters, scan **I 2 of 5 - One Discrete Length**, then scan **1** followed by **4**. To correct an error or to change the selection, scan **Cancel** on page [D-4](#).
- **Two Discrete Lengths** - Select this option to decode only I 2 of 5 symbols containing either of two selected lengths. Select lengths using the numeric bar codes in [Appendix D, Numeric Bar Codes](#). For example, to decode only those I 2 of 5 symbols containing either 2 or 14 characters, select **I 2 of 5 - Two Discrete Lengths**, then scan **0, 2, 1**, and then **4**. To correct an error or to change the selection, scan **Cancel** on page [D-4](#).
- **Length Within Range** - Select this option to decode an I 2 of 5 symbol with a specific length range. Select lengths using numeric bar codes in [Appendix D, Numeric Bar Codes](#). For example, to decode I 2 of 5 symbols containing between 4 and 12 characters, first scan **I 2 of 5 - Length Within Range**. Then scan **0, 4, 1**, and **2** (single digit numbers must always be preceded by a leading zero). To correct an error or change the selection, scan **Cancel** on page [D-4](#).
- **Any Length** - Scan this option to decode I 2 of 5 symbols containing any number of characters within the scanner capability.



Note

Due to the construction of the I 2 of 5 symbology, it is possible for a scan line covering only a portion of the code to be interpreted as a complete scan, yielding less data than is encoded in the bar code. To prevent this, select specific lengths (**I 2 of 5 - One Discrete Length - Two Discrete Lengths**) for I 2 of 5 applications.

Set Lengths for Interleaved 2 of 5 (continued)



I 2 of 5 - One Discrete Length



I 2 of 5 - Two Discrete Lengths

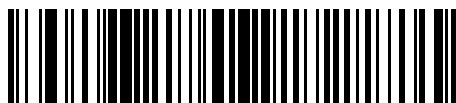

I 2 of 5 - Length Within Range



I 2 of 5 - Any Length

I 2 of 5 Check Digit Verification

When this feature is enabled, the scanner checks the integrity of all I 2 of 5 symbols to verify the data complies with either the specified Uniform Symbology Specification (USS), or the Optical Product Code Council (OPCC) check digit algorithm.



***Disable**



USS Check Digit



OPCC Check Digit

Transmit I 2 of 5 Check Digit

Scan the appropriate bar code below to transmit I 2 of 5 data with or without the check digit.

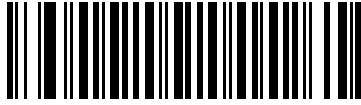

**Transmit I 2 of 5 Check Digit
(Enable)**

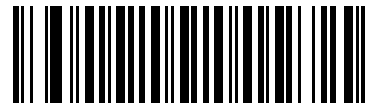

***Do Not Transmit I 2 of 5 Check Digit
(Disable)**

Convert I 2 of 5 to EAN-13

Enable this parameter to convert 14-character I 2 of 5 codes to EAN-13, and transmit to the host as EAN-13. To accomplish this, the I 2 of 5 code must be enabled, and the code must have a leading zero and a valid EAN-13 check digit.

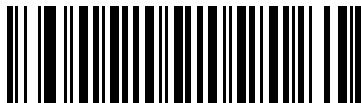

**Convert I 2 of 5 to EAN-13
(Enable)**



***Do Not Convert I 2 of 5 to EAN-13
(Disable)**

Discrete 2 of 5 (DTF)

Enable/Disable Discrete 2 of 5

To enable or disable Discrete 2 of 5, scan the appropriate bar code below.



Enable Discrete 2 of 5

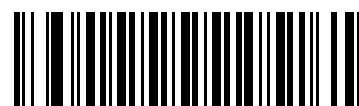

*Disable Discrete 2 of 5

Set Lengths for Discrete 2 of 5

The length of a code refers to the number of characters (i.e., human readable characters), including check digit(s) the code contains. Set lengths for D 2 of 5 to any length, one or two discrete lengths, or lengths within a specific range.

- **One Discrete Length** - Select this option to decode only D 2 of 5 symbols containing a selected length. Select the length using the numeric bar codes in [Appendix D, Numeric Bar Codes](#). For example, to decode only D 2 of 5 symbols with 14 characters, scan **D 2 of 5 - One Discrete Length**, then scan **1** followed by **4**. To correct an error or to change the selection, scan **Cancel** on page [D-4](#).
- **Two Discrete Lengths** - Select this option to decode only D 2 of 5 symbols containing either of two selected lengths. Select lengths using the numeric bar codes in [Appendix D, Numeric Bar Codes](#). For example, to decode only those D 2 of 5 symbols containing either 2 or 14 characters, select **D 2 of 5 - Two Discrete Lengths**, then scan **0, 2, 1**, and then **4**. To correct an error or to change the selection, scan **Cancel** on page [D-4](#).
- **Length Within Range** - Select this option to decode a D 2 of 5 symbol with a specific length range. Select lengths using numeric bar codes in [Appendix D, Numeric Bar Codes](#). For example, to decode D 2 of 5 symbols containing between 4 and 12 characters, first scan **D 2 of 5 - Length Within Range**. Then scan **0, 4, 1**, and **2** (single digit numbers must always be preceded by a leading zero). To correct an error or change the selection, scan **Cancel** on page [D-4](#).
- **Any Length** - Scan this option to decode D 2 of 5 symbols containing any number of characters within the scanner capability.



Note

Due to the construction of the D 2 of 5 symbology, it is possible for a scan line covering only a portion of the code to be interpreted as a complete scan, yielding less data than is encoded in the bar code. To prevent this, select specific lengths (**D 2 of 5 - One Discrete Length - Two Discrete Lengths**) for D 2 of 5 applications.

Set Lengths for Discrete 2 of 5 (continued)



D 2 of 5 - One Discrete Length



D 2 of 5 - Two Discrete Lengths



D 2 of 5 - Length Within Range



D 2 of 5 - Any Length

Chinese 2 of 5

Enable/Disable Chinese 2 of 5

To enable or disable Chinese 2 of 5, scan the appropriate bar code below.



Enable Chinese 2 of 5



***Disable Chinese 2 of 5**

Codabar (NW - 7)

Enable/Disable Codabar

To enable or disable Codabar, scan the appropriate bar code below.

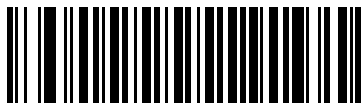

Enable Codabar



*Disable Codabar

Set Lengths for Codabar

The length of a code refers to the number of characters (i.e., human readable characters), including check digit(s) the code contains. Set lengths for Codabar to any length, one or two discrete lengths, or lengths within a specific range.

- **One Discrete Length** - Select this option to decode only Codabar symbols containing a selected length. Select the length using the numeric bar codes in [Appendix D, Numeric Bar Codes](#). For example, to decode only Codabar symbols with 14 characters, scan **Codabar - One Discrete Length**, then scan **1** followed by **4**. To correct an error or to change the selection, scan **Cancel** on page [D-4](#).
- **Two Discrete Lengths** - Select this option to decode only Codabar symbols containing either of two selected lengths. Select lengths using the numeric bar codes in [Appendix D, Numeric Bar Codes](#). For example, to decode only Codabar symbols containing either 2 or 14 characters, select **Codabar - Two Discrete Lengths**, then scan **0, 2, 1**, and then **4**. To correct an error or to change the selection, scan **Cancel** on page [D-4](#).
- **Length Within Range** - Select this option to decode a Codabar symbol with a specific length range. Select lengths using numeric bar codes in [Appendix D, Numeric Bar Codes](#). For example, to decode Codabar symbols containing between 4 and 12 characters, first scan **Codabar - Length Within Range**. Then scan **0, 4, 1**, and **2** (single digit numbers must always be preceded by a leading zero). To correct an error or change the selection, scan **Cancel** on page [D-4](#).
- **Any Length** - Scan this option to decode Codabar symbols containing any number of characters within the scanner capability.

Set Lengths for Codabar (continued).



Codabar - One Discrete Length



Codabar - Two Discrete Lengths



Codabar - Length Within Range



Codabar - Any Length

CLSI Editing

When enabled, this parameter strips the start and stop characters and inserts a space after the first, fifth, and tenth characters of a 14-character Codabar symbol. Enable this feature if your host system requires this data format.



Symbol length does not include start and stop characters.



Enable CLSI Editing

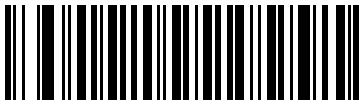

***Disable CLSI Editing**

NOTIS Editing

When enabled, this parameter strips the start and stop characters from a decoded Codabar symbol. Enable this feature if your host system requires this data format.

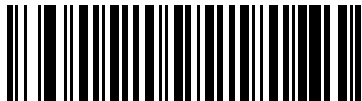

Enable NOTIS Editing



***Disable NOTIS Editing**

MSI

Enable/Disable MSI

To enable or disable MSI, scan the appropriate bar code below.



Enable MSI

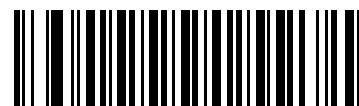

***Disable MSI**

Set Lengths for MSI

The length of a code refers to the number of characters (i.e., human readable characters), including check digit(s) the code contains. Set lengths for MSI to any length, one or two discrete lengths, or lengths within a specific range.

- **One Discrete Length** - Select this option to decode only MSI symbols containing a selected length. Select the length using the numeric bar codes in [Appendix D, Numeric Bar Codes](#). For example, to decode only MSI symbols with 14 characters, scan **MSI - One Discrete Length**, then scan **1** followed by **4**. To correct an error or to change the selection, scan **Cancel** on page [D-4](#).
- **Two Discrete Lengths** - Select this option to decode only MSI symbols containing either of two selected lengths. Select lengths using the numeric bar codes in [Appendix D, Numeric Bar Codes](#). For example, to decode only MSI symbols containing either 2 or 14 characters, select **MSI - Two Discrete Lengths**, then scan **0, 2, 1**, and then **4**. To correct an error or to change the selection, scan **Cancel** on page [D-4](#).
- **Length Within Range** - Select this option to decode a MSI symbol with a specific length range. Select lengths using numeric bar codes in [Appendix D, Numeric Bar Codes](#). For example, to decode MSI symbols containing between 4 and 12 characters, first scan **MSI - Length Within Range**. Then scan **0, 4, 1**, and **2** (single digit numbers must always be preceded by a leading zero). To correct an error or change the selection, scan **Cancel** on page [D-4](#).
- **Any Length** - Scan this option to decode MSI symbols containing any number of characters within the scanner capability.



Note

Due to the construction of the MSI symbology, it is possible for a scan line covering only a portion of the code to be interpreted as a complete scan, yielding less data than is encoded in the bar code. To prevent this, select specific lengths (**MSI - One Discrete Length - Two Discrete Lengths**) for MSI applications.

Set Lengths for MSI (continued)



MSI - One Discrete Length



MSI - Two Discrete Lengths

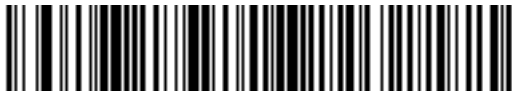

MSI - Length Within Range



MSI - Any Length

MSI Check Digits

With MSI symbols, one check digit is mandatory and always verified by the reader. The second check digit is optional. If the MSI codes include two check digits, scan the **Two MSI Check Digits** bar code to enable verification of the second check digit.

See [MSI Check Digit Algorithm on page 13-45](#) for the selection of second digit algorithms.

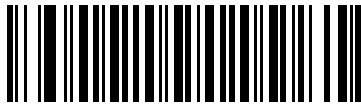

***One MSI Check Digit**

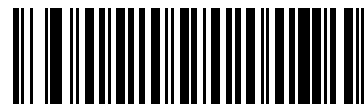

Two MSI Check Digits

Transmit MSI Check Digit(s)

Scan the appropriate bar code below to transmit MSI data with or without the check digit.

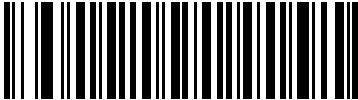

**Transmit MSI Check Digit(s)
(Enable)**

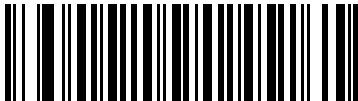

***Do Not Transmit MSI Check Digit(s)
(Disable)**

MSI Check Digit Algorithm

Two algorithms are possible for the verification of the second MSI check digit. Select the bar code below corresponding to the algorithm used to encode your check digit.

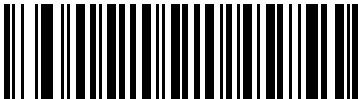

MOD 10/MOD 11

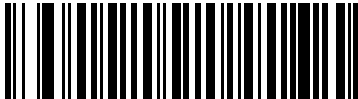

***MOD 10/MOD 10**

RSS (Reduced Space Symbology)

The variants of RSS are RSS 14, RSS Expanded and RSS Limited. RSS 14 and RSS Expanded include stacked versions. Scan the appropriate bar code below to enable or disable each variant of RSS.

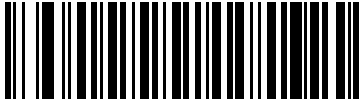

Enable RSS 14

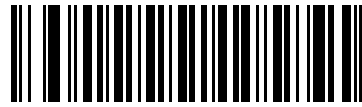

***Disable RSS 14**

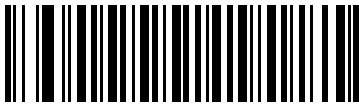

Enable RSS Limited

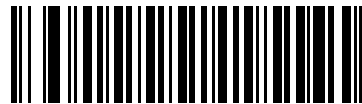

***Disable RSS Limited**



Enable RSS Expanded

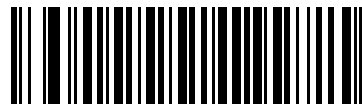

***Disable RSS Expanded**

Convert RSS to UPC/EAN

This parameter only applies to RSS-14 and RSS Limited symbols not decoded as part of a Composite symbol. Enable this to strip the leading '010' from RSS-14 and RSS Limited symbols encoding a single zero as the first digit, and report the bar code as EAN-13.

For bar codes beginning with two or more zeros but not six zeros, this parameter strips the leading '0100' and reports the bar code as UPC-A. The UPC-A Preamble parameter that transmits the system character and country code applies to converted bar codes. Note that neither the system character nor the check digit can be stripped.

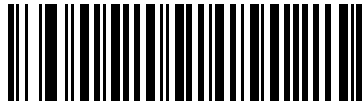

Enable Convert RSS to UPC/EAN

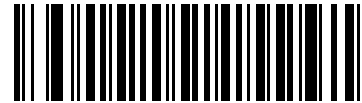

***Disable Convert RSS to UPC/EAN**

Symbology - Specific Security Levels

Redundancy Level

The scanner offers four levels of decode redundancy. Select higher redundancy levels for decreasing levels of bar code quality. As redundancy levels increase, the scanner's aggressiveness decreases.

Select the redundancy level appropriate for the bar code quality.

Redundancy Level 1

The following code types must be successfully read twice before being decoded:

Code Type	Code Length
Codabar	8 characters or less
MSI	4 characters or less
D 2 of 5	8 characters or less
I 2 of 5	8 characters or less

Redundancy Level 2

The following code types must be successfully read twice before being decoded:

Code Type	Code Length
All	All

Redundancy Level 3

Code types other than the following must be successfully read twice before being decoded. The following codes must be read three times:

Code Type	Code Length
MSI	4 characters or less
D 2 of 5	8 characters or less
I 2 of 5	8 characters or less
Codabar	8 characters or less

Redundancy Level 4

The following code types must be successfully read three times before being decoded:

Code Type	Code Length
All	All

Redundancy Level (continued)



***Redundancy Level 1**



Redundancy Level 2

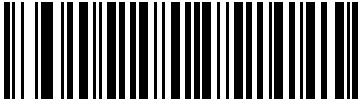

Redundancy Level 3

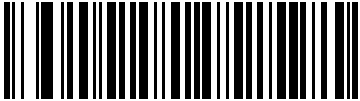

Redundancy Level 4

Security Level

The scanner offers four levels of decode security for delta bar codes, which include the Code 128 family, UPC/EAN, and Code 93. Select increasing levels of security for decreasing levels of bar code quality. There is an inverse relationship between security and scanner aggressiveness, so choose only that level of security necessary for any given application.

- **Security Level 0:** This default setting allows the scanner to operate in its most aggressive state, while providing sufficient security in decoding most “in-spec” bar codes.
- **Security Level 1:** Select this option if misdecodes occur. This security level should eliminate most misdecodes.
- **Security Level 2:** Select this option if Security level 1 fails to eliminate misdecodes.
- **Security Level 3:** If Security Level 2 was selected and misdecodes still occur, select this security level. Be advised, selecting this option is an extreme measure against mis-decoding severely out of spec bar codes. Selecting this level of security significantly impairs the decoding ability of the scanner. If this level of security is necessary, try to improve the quality of the bar codes.

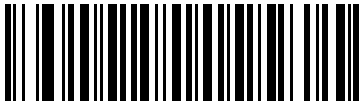

***Security Level 0**

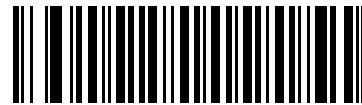

Security Level 1

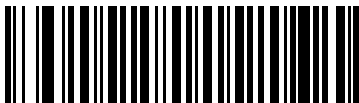

Security Level 2

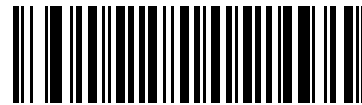

Security Level 3

Bi-directional Redundancy

Enable Bi-directional Redundancy to add security to linear code type security levels. When enabled, a bar code must be successfully scanned in both directions (forward and reverse) before reporting a good decode.



Enable Bi-directional Redundancy

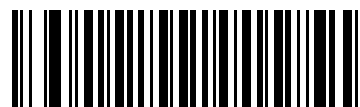

***Disable Bi-directional Redundancy**

Symbology - Intercharacter Gap

The Code 39 and Codabar symbologies have an intercharacter gap that is customarily quite small. Due to various bar code printing technologies, this gap may grow larger than the maximum size allowed, causing the scanner to be unable to decode the symbol. If this problem is encountered, scan **Large Intercharacter Gaps** to tolerate out-of-specification bar codes.



***Normal Intercharacter Gaps**



Large Intercharacter Gaps



Standard Default Parameters

Table A-1. Standard Default Parameters Table

Parameter	Default	Page Number
Radio Communications		
Bluetooth Host	Cradle Host	4-17
Country Keyboard Types (Country Code)	North American	4-18
HID Keyboard Keystroke Delay	No Delay (0 msec)	4-20
CAPS Lock Override	Disable	4-20
Ignore Unknown Characters	Enable	4-21
Emulate Keypad	Disable	4-21
Keyboard FN1 Substitution	Disable	4-22
Function Key Mapping	Disable	4-22
Convert Case	No Case Conversion	4-23
Simulated Caps Lock	Disable	4-23
¹ User selection is required to configure this interface and this is the most common selection.		

Table A-1. Standard Default Parameters Table (Continued)

Parameter	Default	Page Number
Modes of Operation (Point-to-Point/Multipoint-to-Point)	Point-to-Point	4-25
Parameter Broadcast (Cradle Host Only)	Enable	4-26
Pairing Modes	Unlocked	4-27
Pairing on Contacts	Disable	4-27
Connection Maintenance Interval	15 min	4-29
Remote Address (All Bluetooth Host Modes)	No Address	4-31
Authentication	Disable	4-31
Encryption	Disable	4-32
User Preferences		
Beeper Tone	Medium	5-6
Beeper Volume	High	5-6
Power Mode	Reduced Power Mode	5-7
Time Delay to Reduced Power Mode	1 sec	5-7
Scan Pattern	Multi-line Always Raster	5-8
Scan Line Width	Full Width	5-9
Laser On Time	3.0 sec	5-9
Beep After Good Decode	Enable	5-10
Transmit Code ID Character	None	5-10
Prefix Value	7013 <CR><LF>	5-11
Suffix Value	7013 <CR><LF>	5-11
Scan Data Transmission Format	Data As Is	5-12
FN1 Substitution Values	Set	5-13
Transmit "No Read" Message	Disable	5-13
Synapse Interface	Standard	5-14
Batch Mode	Normal (Do Not Batch Data)	5-16
Keyboard Wedge Host Parameters		
¹ User selection is required to configure this interface and this is the most common selection.		

Table A-1. Standard Default Parameters Table (Continued)

Parameter	Default	Page Number
Keyboard Wedge Host Type	IBM PC/AT& IBM PC Compatibles ¹	6-6
Country Types (Country Codes)	North American	6-7
Ignore Unknown Characters	Send	6-8
Keystroke Delay	No Delay	6-9
Intra-Keystroke Delay	Disable	6-9
Alternate Numeric Keypad Emulation	Disable	6-10
Caps Lock On	Disable	6-10
Caps Lock Override	Disable	6-10
Convert Wedge Data	No Convert	6-11
Function Key Mapping	Disable	6-11
FN1 Substitution	Disable	6-12
Send and Make Break	Send	6-12
RS-232 Host Parameters		
RS-232 Host Types	Standard	7-8
Baud Rate	9600	7-9
Parity Type	None	7-10
Stop Bit Select	1 Stop Bit	7-11
Data Bits (ASCII Format)	8-Bit	7-11
Check Receive Errors	Enable	7-12
Hardware Handshaking	None	7-13
Software Handshaking	None	7-14
Host Serial Response Time-out	2 sec	7-15
RTS Line State	Low RTS	7-16
Beep on <BEL>	Disable	7-16
Intercharacter Delay	0 msec	7-17
Nixdorf Beep/LED Options	Normal Operation	7-18
Ignore Unknown Characters	Send Bar Code	7-18
¹ User selection is required to configure this interface and this is the most common selection.		

Table A-1. Standard Default Parameters Table (Continued)

Parameter	Default	Page Number
USB Host Parameters		
USB Device Type	HID Keyboard Emulation	8-6
USB Country Keyboard Types (Country Codes)	North American	8-6
USB Keystroke Delay	No Delay	8-9
USB CAPS Lock Override	Disable	8-9
USB Ignore Unknown Characters	Send	8-10
Emulate Keypad	Disable	8-10
USB FN1 Substitution	Disable	8-11
Function Key Mapping	Disable	8-11
Simulated Caps Lock	Disable	8-12
Convert Case	No Case Conversion	8-12
IBM 468X/469X Host Parameters		
Port Address	None Selected	9-6
Convert Unknown to Code 39	Disable	9-7
Wand Emulation Host Parameters		
Wand Emulation Host Types	Symbol OmniLink Interface Controller ¹	10-6
Leading Margin	80 msec	10-7
Polarity	Bar High/Margin Low	10-8
Ignore Unknown Characters	Send	10-8
Convert All Bar Codes to Code 39	Disable	10-9
Convert Code 39 to Full ASCII	Disable	10-10
Scanner Emulation		
Beep Style	Beep on Successful Transmit	11-6
Parameter Pass-Through	Parameter Process and Pass Through	11-7
Convert Newer Code Types	Convert Newer Code Types	11-7
Module Width	20 μ s	11-8
¹ User selection is required to configure this interface and this is the most common selection.		

Table A-1. Standard Default Parameters Table (Continued)

Parameter	Default	Page Number
Convert All Bar Codes to Code 39	Do Not Convert Bar Codes to Code 39	11-8
Code 39 Full ASCII Conversion	Disable	11-8
Transmission Timeout	3 sec	11-9
Ignore Unknown Characters	Ignore Unknown Characters	11-10
Leading Margin	2 ms	11-10
Check for Decode LED	Check for Decode LED	11-11
123Scan Configuration Tool		
123Scan Configuration	None ¹	12-3
UPC/EAN		
UPC-A	Enable	13-5
UPC-E	Enable	13-9
UPC-E1	Disable	13-10
EAN-8/JAN 8	Enable	13-10
EAN-13/JAN 13	Enable	13-10
Bookland EAN	Disable	13-11
Decode UPC/EAN/JAN Supplementals (2 and 5 digits)	Ignore	13-12
Decode UPC/EAN/JAN Supplemental Redundancy	7	13-13
Transmit UPC-A Check Digit	Enable	13-13
Transmit UPC-E Check Digit	Enable	13-13
Transmit UPC-E1 Check Digit	Enable	13-14
UPC-A Preamble	System Character	13-14
UPC-E Preamble	System Character	13-15
UPC-E1 Preamble	System Character	13-16
Convert UPC-E to A	Disable	13-16
Convert UPC-E1 to A	Disable	13-17
EAN-8/JAN-8 Extend	Disable	13-17
UCC Coupon Extended Code	Disable	13-18
¹ User selection is required to configure this interface and this is the most common selection.		

Table A-1. Standard Default Parameters Table (Continued)

Parameter	Default	Page Number
Code 128		
Code 128	Enable	13-19
UCC/EAN-128	Enable	13-19
ISBT 128 (non-concatenated)	Enable	13-20
Code 39		
Code 39	Enable	13-21
Trioptic Code 39	Disable	13-21
Convert Code 39 to Code 32 (Italian Pharmacy Code)	Disable	13-22
Code 32 Prefix	Disable	13-22
Set Length(s) for Code 39	2 to 55	13-23
Code 39 Check Digit Verification	Disable	13-24
Transmit Code 39 Check Digit	Disable	13-24
Code 39 Full ASCII Conversion	Disable	13-25
Buffer Code 39	Disable	13-26
Code 93		
Code 93	Disable	13-29
Set Length(s) for Code 93	4 to 55	13-30
Code 11		
Code 11	Disable	13-31
Set Lengths for Code 11	4 to 55	13-32
Code 11 Check Digit Verification	Disable	13-33
Transmit Code 11 Check Digit(s)	Disable	13-33
Interleaved 2 of 5 (ITF)		
Interleaved 2 of 5 (ITF)	Enable	13-34
Set Lengths for I 2 of 5	14	13-35
I 2 of 5 Check Digit Verification	Disable	13-35
Transmit I 2 of 5 Check Digit	Disable	13-36
¹ User selection is required to configure this interface and this is the most common selection.		

Table A-1. Standard Default Parameters Table (Continued)

Parameter	Default	Page Number
Convert I 2 of 5 to EAN 13	Disable	13-36
Discrete 2 of 5 (DTF)		
Discrete 2 of 5	Disable	13-37
Set Length(s) for D 2 of 5	12	13-38
Chinese 2 of 5		
Enable/Disable Chinese 2 of 5	Disable	13-39
Codabar (NW - 7)		
Codabar	Disable	13-40
Set Lengths for Codabar	5 to 55	13-41
CLSI Editing	Disable	13-41
NOTIS Editing	Disable	13-42
MSI		
MSI	Disable	13-43
Set Length(s) for MSI	2 to 55	13-44
MSI Check Digits	One	13-44
Transmit MSI Check Digit	Disable	13-45
MSI Check Digit Algorithm	Mod 10/Mod 10	13-45
RSS (Reduced Space Symbology)		
RSS 14	Disable	13-46
RSS Limited	Disable	13-46
RSS Expanded	Disable	13-46
Convert RSS to UPC/EAN	Disable	13-47
Symbology - Specific Security Levels		
Redundancy Level	1	13-49
Security Levels	0	13-50
Bi-directional Redundancy	Disable	13-51
¹ User selection is required to configure this interface and this is the most common selection.		

B

Programming Reference

Symbol Code Identifiers	B-3
AIM Code Identifiers	B-4

Symbol Code Identifiers

Table B-1. Symbol Code Characters

Code Character	Code Type
A	UPC/EAN
B	Code 39, Code 39 Full ASCII, Code 32
C	Codabar
D	Code 128, ISBT 128
E	Code 93
F	Interleaved 2 of 5
G	Discrete 2 of 5, or Discrete 2 of 5 IATA
H	Code 11
J	MSI
K	UCC/EAN-128
L	Bookland EAN
M	Trioptic Code 39
N	Coupon Code
R	RSS Family

AIM Code Identifiers

Each AIM Code Identifier contains the three-character string **Jcm** where:

J = Flag Character (ASCII 93)

c = Code Character (see [Table B-2](#))

m = Modifier Character (see [Table B-3](#))

Table B-2. Aim Code Characters

Code Character	Code Type
A	Code 39, Code 39 Full ASCII, Code 32
C	Code 128 (all variants), Coupon (Code 128 portion)
E	UPC/EAN, Coupon (UPC portion)
e	RSS Family
F	Codabar
G	Code 93
H	Code 11
I	Interleaved 2 of 5
M	MSI
S	D2 of 5, IATA 2 of 5
X	Bookland EAN, Code 39 Trioptic

The modifier character is the sum of the applicable option values based on [Table B-3](#).

Table B-3. Modifier Characters

Code Type	Option Value	Option
Code 39	0	No check character or Full ASCII processing.
	1	Reader has checked one check character.
	3	Reader has checked and stripped check character.
	4	Reader has performed Full ASCII character conversion.
	5	Reader has performed Full ASCII character conversion and checked one check character.
	7	Reader has performed Full ASCII character conversion and checked and stripped check character.
	Example: A Full ASCII bar code with check character W, A+I+MI+DW , is transmitted as JA7 AIMID where 7 = (3+4).	
Trioptic Code 39	0	No option specified at this time. Always transmit 0.
	Example: A Trioptic bar code 412356 is transmitted as JX0 412356	

Table B-3. Modifier Characters (Continued)

Code Type	Option Value	Option
Code 128	0	Standard data packet, no Function code 1 in first symbol position.
	1	Function code 1 in first symbol character position.
	2	Function code 1 in second symbol character position.
	Example: A Code (EAN) 128 bar code with Function 1 character FNC1 in the first position, AIMID is transmitted as Jc1 AIMID	
I 2 of 5	0	No check digit processing.
	1	Reader has validated check digit.
	3	Reader has validated and stripped check digit.
	Example: An I 2 of 5 bar code without check digit, 4123, is transmitted as Ji0 4123	
Codabar	0	No check digit processing.
	1	Reader has checked check digit.
	3	Reader has stripped check digit before transmission.
	Example: A Codabar bar code without check digit, 4123, is transmitted as JF0 4123	
Code 93	0	No options specified at this time. Always transmit 0.
	Example: A Code 93 bar code 012345678905 is transmitted as JG00 12345678905	
MSI	0	Check digits are sent.
	1	No check digit is sent.
	Example: An MSI bar code 4123, with a single check digit checked, is transmitted as JM1 4123	
D 2 of 5	0	No options specified at this time. Always transmit 0.
	Example: A D 2 of 5 bar code 4123, is transmitted as JS0 4123	
UPC/EAN	0	Standard packet in full EAN country code format, which is 13 digits for UPC-A and UPC-E (not including supplemental data).
	1	Two-digit supplement data only.
	2	Five-digit supplement data only.
	4	EAN-8 data packet.
	Example: A UPC-A bar code 012345678905 is transmitted as JE000 12345678905	
Bookland EAN	0	No options specified at this time. Always transmit 0.
	Example: A Bookland EAN bar code 123456789X is transmitted as JX0 123456789X	
Code 11	0	Single check digit
	1	Two check digits
	3	Check characters validated but not transmitted.
RSS Family		No option specified at this time. Always transmit 0. RSS-14 and RSS-Limited transmit with an Application Identifier "01". Note: In UCC/EAN-128 emulation mode, RSS is transmitted using Code 128 rules (i.e., Jc1).
Example: An RSS-14 bar code 100123456788902 is transmitted as Je001 100123456788902.		



Sample Bar Codes

Code 39.....	C-3
UPC/EAN	C-3
UPC-A, 100%	C-3
EAN-13, 100%	C-3
Code 128.....	C-3
Interleaved 2 of 5.....	C-4
RSS.....	C-4
RSS.....	C-4
RSS-14	C-5

Code 39



UPC/EAN

UPC-A, 100%



EAN-13, 100%



Code 128



Interleaved 2 of 5



RSS



RSS variants must be enabled to read the bar codes below (see [RSS \(Reduced Space Symbology\)](#) on page 13-46).

RSS



10293847560192837465019283746029478450366523
(RSS Expanded Stacked)



1234890hjo9900mnb
(RSS Expanded)



08672345650916
(RSS Limited)

RSS-14



55432198673467
(RSS-14 Truncated)



90876523412674
(RSS-14 Stacked)



78123465709811
(RSS-14 Stacked Omni-Directional)



Numeric Bar Codes

Numeric Bar Codes	D-3
Cancel	D-4

Numeric Bar Codes

For parameters requiring specific numeric values, scan the appropriately numbered bar code(s).



0



1

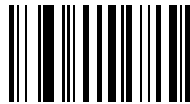

2



3

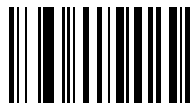

4



5

Numeric Bar Codes

For parameters requiring specific numeric values, scan the appropriately numbered bar code(s).



6

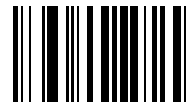

7



8

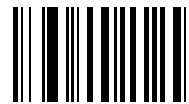

9

Cancel

To correct an error or change a selection, scan the bar code below.



Cancel



Alphanumeric Bar Codes

Alphanumeric Keyboard E-3

Alphanumeric Keyboard

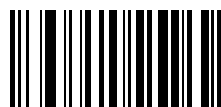

Space



#



\$



%



*



+

Alphanumeric Keyboard (continued)

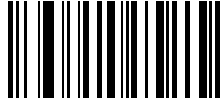

-

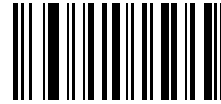

.

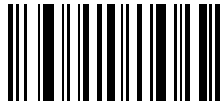

/



!

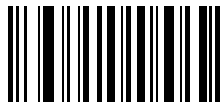

"



&

Alphanumeric Keyboard (continued)

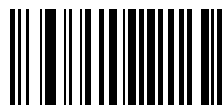

'



(



)



;



;



<

Alphanumeric Keyboard (continued)



=



>



?



@



[



\

Alphanumeric Keyboard (continued)



]



^

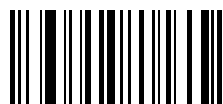

-

Alphanumeric Keyboard (continued)



The bar codes that follow should not be confused with those on the numeric keypad.

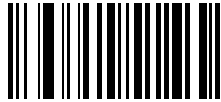

~

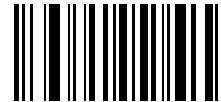

0



1

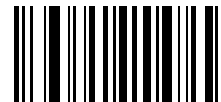

2

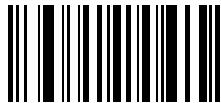

3

Note: The bar codes in this table should not be confused with those on the numeric keypad.

Alphanumeric Keyboard (continued)



4



5

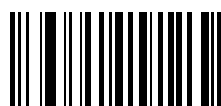

6



7

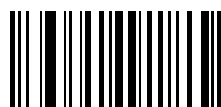

8



9

Note: The bar codes in this table should not be confused with those on the numeric keypad.

Alphanumeric Keyboard (continued)

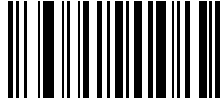

A

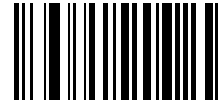

B

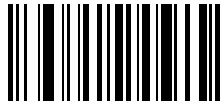

C



D

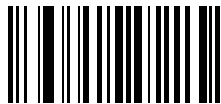

E



F

Alphanumeric Keyboard (continued)

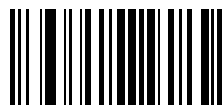

G



H

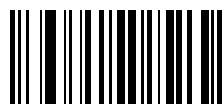

I



J



K



L

Alphanumeric Keyboard (continued)



M

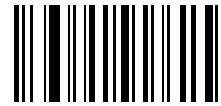

N



O

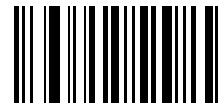

P

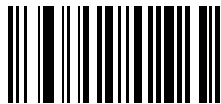

Q



R

Alphanumeric Keyboard (continued)



S



T

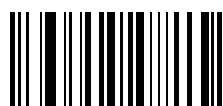

U



V

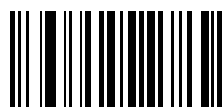

W



X

Alphanumeric Keyboard (continued)



Y



Z

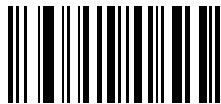

a



b



c



d

Alphanumeric Keyboard (continued)

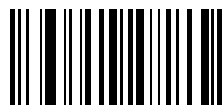

e



f

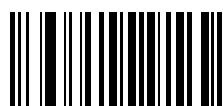

g



h

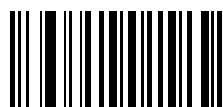

i



j

Alphanumeric Keyboard (continued)



k

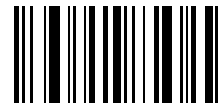

l



m

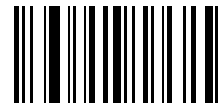

n

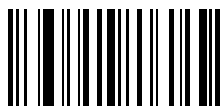

o

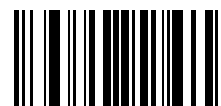

p

Alphanumeric Keyboard (continued)



q



r

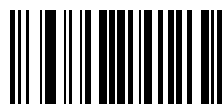

s



t

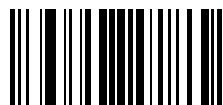

u



v

Alphanumeric Keyboard (continued)



w

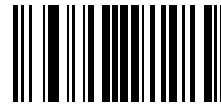

x



y

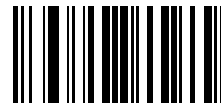

z

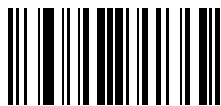

{



|

Alphanumeric Keyboard (continued)



}



~



ASCII Character Sets

Table F-1. ASCII Value Standard Default Parameters Table

ASCII Value	Full ASCII Code 39 Encode Character	Keystroke
1000	%U	CTRL 2
1001	\$A	CTRL A
1002	\$B	CTRL B
1003	\$C	CTRL C
1004	\$D	CTRL D
1005	\$E	CTRL E
1006	\$F	CTRL F
1007	\$G	CTRL G
1008	\$H	CTRL H/ BACKSPACE ¹
1009	\$I	CTRL I/ HORIZONTAL TAB ¹
1010	\$J	CTRL J
1011	\$K	CTRL K
1012	\$L	CTRL L

Table F-1. ASCII Value Standard Default Parameters Table (Continued)

ASCII Value	Full ASCII Code 39 Encode Character	Keystroke
1013	\$M	CTRL M/ ENTER ¹
1014	\$N	CTRL N
1015	\$O	CTRL O
1016	\$P	CTRL P
1017	\$Q	CTRL Q
1018	\$R	CTRL R
1019	\$S	CTRL S
1020	\$T	CTRL T
1021	\$U	CTRL U
1022	\$V	CTRL V
1023	\$W	CTRL W
1024	\$X	CTRL X
1025	\$Y	CTRL Y
1026	\$Z	CTRL Z
1027	%A	CTRL [
1028	%B	CTRL \
1029	%C	CTRL]
1030	%D	CTRL 6
1031	%E	CTRL -
1032	Space	Space
1033	/A	!
1034	/B	"
1035	/C	#
1036	/D	?
1037	/E	%
1038	/F	&
1039	/G	'
1040	/H	(

Table F-1. ASCII Value Standard Default Parameters Table (Continued)

ASCII Value	Full ASCII Code 39 Encode Character	Keystroke
1041	/I)
1042	/J	*
1043	/K	+
1044	/L	,
1045	-	-
1046	.	.
1047	/O	/
1048	0	0
1049	1	1
1050	2	2
1051	3	3
1052	4	4
1053	5	5
1054	6	6
1055	7	7
1056	8	8
1057	9	9
1058	/Z	:
1059	%F	;
1060	%G	<
1061	%H	=
1062	%I	>
1063	%J	?
1064	%V	@
1065	A	A
1066	B	B
1067	C	C
1068	D	D

Table F-1. ASCII Value Standard Default Parameters Table (Continued)

ASCII Value	Full ASCII Code 39 Encode Character	Keystroke
1069	E	E
1070	F	F
1071	G	G
1072	H	H
1073	I	I
1074	J	J
1075	K	K
1076	L	L
1077	M	M
1078	N	N
1079	O	O
1080	P	P
1081	Q	Q
1082	R	R
1083	S	S
1084	T	T
1085	U	U
1086	V	V
1087	W	W
1088	X	X
1089	Y	Y
1090	Z	Z
1091	%K	[
1092	%L	\
1093	%M]
1094	%N	^
1095	%O	_
1096	%W	'

Table F-1. ASCII Value Standard Default Parameters Table (Continued)

ASCII Value	Full ASCII Code 39 Encode Character	Keystroke
1097	+A	a
1098	+B	b
1099	+C	c
1100	+D	d
1101	+E	e
1102	+F	f
1103	+G	g
1104	+H	h
1105	+I	i
1106	+J	j
1107	+K	k
1108	+L	l
1109	+M	m
1110	+N	n
1111	+O	o
1112	+P	p
1113	+Q	q
1114	+R	r
1115	+S	s
1116	+T	t
1117	+U	u
1118	+V	v
1119	+W	w
1120	+X	x
1121	+Y	y
1122	+Z	z
1123	%P	{
1124	%Q	

Table F-1. ASCII Value Standard Default Parameters Table (Continued)

ASCII Value	Full ASCII Code 39 Encode Character	Keystroke
1125	%R	}
1126	%S	~
The keystroke in bold is sent only if the "Function Key Mapping" is enabled. Otherwise, the unbolded keystroke is sent.		

Table F-2. ALT Key Standard Default Tables

ALT Keys	Keystroke
2064	ALT 2
2065	ALT A
2066	ALT B
2067	ALT C
2068	ALT D
2069	ALT E
2070	ALT F
2071	ALT G
2072	ALT H
2073	ALT I
2074	ALT J
2075	ALT K
2076	ALT L
2077	ALT M
2078	ALT N
2079	ALT O
2080	ALT P
2081	ALT Q
2082	ALT R
2083	ALT S
2084	ALT T
2085	ALT U
2086	ALT V
2087	ALT W
2088	ALT X
2089	ALT Y
2090	ALT Z

Table F-3. Misc. Key Standard Default Table

Misc. Key	Keystroke
3001	PA 1
3002	PA 2
3003	CMD 1
3004	CMD 2
3005	CMD 3
3006	CMD 4
3007	CMD 5
3008	CMD 6
3009	CMD 7
3010	CMD 8
3011	CMD 9
3012	CMD 10
3013	CMD 11
3014	CMD 12
3015	CMD 13
3016	CMD 14

Table F-4. GUI Shift Keys

GUI Shift Keys	
The Apple™ iMac keyboard has an apple key on either side of the space bar. Windows-based systems have a GUI key to the left of the left ALT key, and to the right of the right ALT key.	
Other Value	Keystroke
3048	GUI 0
3049	GUI 1
3050	GUI 2
3051	GUI 3
3052	GUI 4
3053	GUI 5
3054	GUI 6
3055	GUI 7
3056	GUI 8
3057	GUI 9
3065	GUI A
3066	GUI B
3067	GUI C

Table F-4. GUI Shift Keys (Continued)

3068	GUI D
3069	GUI E
3070	GUI F
3071	GUI G
3072	GUI H
3073	GUI I
3074	GUI J
3075	GUI K
3076	GUI L
3077	GUI M
3078	GUI N
3079	GUI O
3080	GUI P
3081	GUI Q
3082	GUI R
3083	GUI S
3084	GUI T
3085	GUI U
3086	GUI V
3087	GUI W
3088	GUI X
3089	GUI Y
3090	GUI Z

Table F-5. PF Key Standard Default Table

PF Keys	Keystroke
4001	PF 1
4002	PF 2
4003	PF 3
4004	PF 4
4005	PF 5
4006	PF 6
4007	PF 7
4008	PF 8
4009	PF 9

Table F-5. PF Key Standard Default Table (Continued)

PF Keys	Keystroke
4010	PF 10
4011	PF 11
4012	PF 12
4013	PF 13
4014	PF 14
4015	PF 15
4016	PF 16

Table F-6. F key Standard Default Table

F Keys	Keystroke
5001	F 1
5002	F 2
5003	F 3
5004	F 4
5005	F 5
5006	F 6
5007	F 7
5008	F 8
5009	F 9
5010	F 10
5011	F 11
5012	F 12
5013	F 13
5014	F 14
5015	F 15
5016	F 16
5017	F 17
5018	F 18
5019	F 19
5020	F 20
5021	F 21
5022	F 22
5023	F 23
5024	F 24

Table F-7. Numeric Key Standard Default Table

Numeric Keypad	Keystroke
6042	*
6043	+
6044	Undefined
6045	-
6046	.
6047	/
6048	0
6049	1
6050	2
6051	3
6052	4
6053	5
6054	6
6055	7
6056	8
6057	9
6058	Enter
6059	Num Lock

Table F-8. Extended Keypad Standard Default Table

Extended Keypad	Keystroke
7001	Break
7002	Delete
7003	Pg Up
7004	End
7005	Pg Dn
7006	Pause
7007	Scroll Lock
7008	Backspace
7009	Tab
7010	Print Screen
7011	Insert
7012	Home

Table F-8. Extended Keypad Standard Default Table (Continued)

Extended Keypad	Keystroke
7013	Enter
7014	Escape
7015	Up Arrow
7016	Dn Arrow
7017	Left Arrow
7018	Right Arrow

Glossary

AIM	Automatic Identification Manufacturers, Inc. is the trade association for manufacturers of automatic identification systems.
Alphanumeric	A character set that contains letters, numbers and other characters such as special symbols.
Aperture	The opening in an optical system defined by a lens or baffle that establishes the field of view.
ASCII	American Standard Code for Information Interchange. A 7-bit-plus-parity code representing 128 letters, numerals, punctuation marks, and control characters. It is a standard data transmission code in the U.S.
Aspect Ratio	The ratio of symbol height to symbol length in a 2-dimensional symbol.
Authentication	Security measure designed to establish the validity of a transmission, message, or originator, or a means of verifying an individual's authorization to receive specific categories of information.

Autodiscrimination	The ability of an interface controller to determine the code type of a scanned bar code. After this determination is made, the information content is decoded.
Automatic Identification System	The application of various technologies, such as bar code recognition, image recognition, voice recognition and RF/MW transponders, for the purpose of data entry into a data processing system and bypassing the key-entry component of traditional data entry.
Background	The area surrounding a printed symbol including the spaces and quiet zones.
Bar	The dark element in a printed bar code symbol.
Bar Code	An array of parallel rectangular bars and spaces arranged according to the encodation rules of a particular symbol specification in order to represent data in machine-readable form (i.e., Code 39).
Bar Code Character	A single group of bars and spaces which represent an individual number, letter, punctuation mark or other symbol.
Bar Code Density	The number of characters represented per unit of measurement (e.g., characters per inch).
Bar Code Reader	A device used to read or decode a bar code symbol.
Bar Code Symbol	The combination of symbol characters and features required by a particular symbology, including quiet zones, start and stop characters, data characters, check characters and other auxiliary patterns, that together form a complete scannable entity (see <i>Symbol</i>).
Bar Height	The dimension of a bar measured perpendicular to the bar width (see <i>Y Dimension</i>).
Bar Width	Thickness of a bar measured from the edge closest to the symbol start character to the trailing edge of the same bar (see <i>X Dimension</i>).
Baud Rate	A measure of the data flow or number of signaling events occurring per second. When one bit is the standard "event," this is a measure of bits per second (bps). For example, a baud rate of 50 means transmission of 50 bits of data per second.
Bi-directional	Denotes that a machine-readable symbol can be read successfully in two directions – either backwards or forwards. Also identifies a scanner that can operate on a bar code that can be read independent of scanning direction.
Binary	Denotes a numbering system to base 2 in which numbers are expressed as combinations of the digits 0 and 1 with positional weighting based on powers of 2. In computing, these can be represented electrically by 'off' and 'on' respectively or in machine-readable symbols by narrow and wide elements or by the absence or presence of a bar module.

Bit	Binary digit. One bit is the basic unit of binary information. Generally, eight consecutive bits compose one byte of data. The pattern of 0 and 1 values within the byte determines its meaning.
Bluetooth Address	A unique 12-character hexadecimal, IEEE 48-bit address (BT_ADDR) that represents a Bluetooth device.
Bluetooth Controller	A sub-system containing Bluetooth RF, baseband, resource controller, link manager, device manager, and Bluetooth HCI.
Bluetooth Device:	A device that is capable of short-range wireless communication using the Bluetooth system.
BT	Abbreviation for Bluetooth. Bluetooth protocol is a predefined rule that sets out a specific system for devices to communicate with each other and a protocol stack is the layering of the protocols that are used in a specific technology. The Bluetooth Radio protocol operates in the 2.4GHz ISM band.
Class 1 Bluetooth	Standard for Bluetooth radio transmission for a range of up to 100m.
Class 2 Bluetooth	Standard for Bluetooth radio that restricts the transmission range to 10m in order to reduce the effect of the radio on neighboring wireless systems.
Byte	A sequential series of bits comprising one character and handled as one unit. Usually encoded in the ASCII format, a byte usually consists of eight bits and represents one alphabetic or special character, two decimal digits or eight binary bits.
CDRH	Center for Devices and Radiological Health. A federal agency responsible for regulating laser product safety. This agency specifies various laser operation classes based on power output during operation.
CDRH Class 1	This is the lowest power CDRH laser classification. This class is considered intrinsically safe, even if all laser output were directed into the eye's pupil. There are no special operating procedures for this class.
CDRH Class 2	No additional software mechanisms are needed to conform to this limit. Laser operation in this class poses no danger for unintentional direct human exposure.
Character	A pattern of bars and spaces which either directly represents data or indicates a control function, such as a number, letter, punctuation mark, or communications control contained in a message.
Character Set	Those characters available for encoding in a particular bar code symbology.
Check Digit	A digit used to verify a correct symbol decode. The scanner inserts the decoded data into an arithmetic formula and checks that the resulting number matches the encoded check digit. Check digits are required for UPC but are optional for other symbologies. Using check digits decreases the chance of substitution errors when a symbol is decoded.

Codabar	A discrete self-checking code with a character set consisting of digits 0 to 9 and six additional characters: (- \$: / , +).
Code	A set of unambiguous rules specifying the way in which data may be represented as numbers and letters used to represent information.
Code 11	A high density numeric symbology requiring a checksum for calculation. The Code 11 character set consists of bar code symbols representing the numbers 0-9, a dash symbol, the start character, and the stop character.
Code 128	A high density symbology which allows the controller to encode all 128 ASCII characters without adding extra symbol elements.
Code 3 of 9 (Code 39)	A versatile and widely used alphanumeric bar code symbology with a set of 43 character types, including all uppercase letters, numerals from 0 to 9, and 7 special characters (- . / + % \$ and space). The code name is derived from the fact that 3 of 9 elements representing a character are wide, while the remaining 6 are narrow.
Code 49	This symbol is a stack of 2 to 8 rows. Each row encodes row count information plus data characters. For more information, go to the AIM web site or the ANSI web site (see Stacked Symbol (2D Symbols)).
Code 93	An industrial symbology compatible with Code 39 but offering a full character ASCII set and a higher coding density than Code 39.
Code Length	Number of data characters in a bar code between the start and stop characters, not including those characters.
Codeword	As a symbol character value, this is an intermediate level of coding between source data and the graphical encodation in the symbol.
Concatenation	The construction of a string of data from two or more strings by appending each string in succession. The linking or chaining together of separate items of data in a bar code symbol or of the data contained in two or more separate bar code symbols (also referred to as message append and structured append).
Continuous Code	A bar code or symbol in which all spaces within the symbol are parts of characters. There are no intercharacter gaps in a continuous code. The absence of gaps allows for greater information density.
Contrast	The difference in reflectance between the black and white (or bar and space) areas of a symbol.
Data Identifier	A specified character or string of characters that defines the intended use of the data element that follows. For the purposes of automatic data capture technologies, data identifier refers to the alphanumeric identifiers as defined in ANSI MH10.8.2, formerly known as ANSI/FACT data identifiers.

Data Matrix	<p>This error correcting, 2-dimensional matrix symbology is capable of encoding various character sets including strictly numeric data, alphanumeric data and all ISO 646 (ASCII) characters, as well as special character sets. The symbology has both error detection and error correction features. Each Data Matrix symbol consists of data regions, which contain nominally square modules set out in a regular array. A dark module is a binary 1 and a light module is a binary 0. There is no specified minimum or maximum for the X or Y dimension. The data region is surrounded by a finder pattern, a perimeter to the data region that is 1 module wide, which is surrounded by a quiet zone on all four sides of the symbol. Two adjacent sides are solid dark lines used primarily to define physical size, orientation and symbol distortion. The two opposite sides consist of alternating dark and light modules. These are used primarily to define the cell structure but also assist in determining physical size and distortion.</p> <p>There are 2 types of Data Matrix symbologies: ECC 000 - 140 with several available levels of convolutional error correction, and ECC 200, which uses Reed-Solomon error correction. For ISO/IEC JTC 1/SC 31 purposes, only ECC 200 is recommended. The intellectual property rights associated with Data Matrix have been committed to the public domain.</p>
Data Structure	<p>The stipulation of the type of information that is included in a bar code, such as its order and format.</p>
Dead Zone	<p>An area within a scanner's field of view, in which specular reflection may prevent a successful decode.</p>
Decode	<p>To recognize a bar code symbology (e.g., UPC/EAN) and then analyze the content of the specific bar code scanned.</p>
Decode Algorithm	<p>A decoding scheme that converts pulse widths into data representation of the letters or numbers encoded within a bar code symbol.</p>
Decoder	<p>An electronic package that receives the signals from the scanning function, performs the algorithm to interpret the signals into meaningful data and provides the interface to other devices.</p>
Density	<p>Describes the relative amount of memory contained in a radio frequency identification tag (see Bar Code Density).</p>
Depth of Field	<p>The range between minimum and maximum distances at which a scanner can read a symbol with a certain minimum element width.</p>
Diffuse Reflection	<p>The component of reflected light that emanates in all directions from the reflecting surface.</p>
Discrete 2 of 5	<p>A binary bar code symbology representing each character by a group of five bars, two of which are wide. The location of wide bars in the group determines which character is encoded; spaces are insignificant. Only numeric characters (0 to 9) and START/STOP characters may be encoded.</p>
Discrete Code	<p>A bar code or symbol in which the spaces between characters (intercharacter gaps) are not part of the code.</p>

EAN	European Article Number. This European/international version of the UPC provides its own coding format and symbology standards. Element dimensions are specified metrically. EAN is used primarily in retail.
EAN/U.P.C.	A fixed-length, numeric 13-digit bar code symbol consisting of 30 dark elements and 29 intervening light elements. Each character is represented by 2 bars and 2 spaces over 7 modules. A bar may be comprised of 1, 2, 3 or 4 modules. Each EAN/U.P.C. symbol consists of a leading quiet zone, a start pattern, 7 left-hand data characters, a center bar pattern, 5 right-hand data characters, a Modulo 10 check character, a stop pattern and a trailing quiet zone. U.P.C. is often considered a 12-digit code. The 13th digit of EAN/U.P.C. symbol is a derived character in the left-most position. In the case of U.P.C., this derived left-most character is a 0.
Element	Generic term for a bar or space.
Encoded Area	Total linear dimension occupied by all characters of a code pattern, including start/stop characters and data.
Encryption	Encryption is the scrambling and coding of data, typically using mathematical formulas called algorithms, before information is transmitted over any communications link or network. A key is the specific code used by the algorithm to encrypt or decrypt the data.
Error Correction	A reader or decoder's use of mathematical schemes to reconstruct or replace damaged or missing symbol characters to enable the reading of the symbol data.
Error Detection	This occurs when error-correction characters detect that the presence of errors in the symbol exceeds the error correction capacity, and keeps the symbol from being decoded as erroneous data.
Error-Correction Characters	Symbol characters used for error correction and detection, calculated automatically from the other symbol characters.
Error-Correction Level	An indicator of the number of characters used in a symbology for error correction. A higher level of error correction allows for correcting greater potential symbol damage.
Error-Detection Characters	Symbol characters reserved for error detection that are calculated automatically from the other symbol characters.
Fixed Beam Bar Code Reader	A scanning device where scanning motion is achieved by moving the object relative to the reader; as opposed to a moving beam reader.
Guard Bars	Bars located at both ends and the center of a UPC and EAN symbol to provide reference points for scanning.
Horizontal Bar Code	A bar code or symbol with an overall length dimension that is parallel to the horizon, which resembles a picket fence.
Host Computer	A computer that serves other terminals in a network, providing such services as computation, database access, supervisory programs, and network control.

IEC	International Electrotechnical Commission. This international agency regulates laser safety by specifying various laser operation classes based on power output during operation.
IEC (825) Class 1	This is the lowest power IEC laser classification. Conformity is ensured through a software restriction of 120 seconds of laser operation within any 1000 second window and an automatic laser shutdown if the scanner's oscillating mirror fails.
Intercharacter Gap	The space between two adjacent bar code characters in a discrete code.
Interleaved 2 of 5	A binary bar code symbology representing character pairs in groups of five bars and five interleaved spaces. Interleaving provides for greater information density. The location of wide elements (bar/spaces) within each group determines which characters are encoded. This continuous code type uses no intercharacter spaces. Only numeric (0 to 9) and START/STOP characters may be encoded.
Interleaved Bar Code	A bar code in which characters are paired together, using bars to represent the first character and the intervening spaces to represent the second.
LASER - Light Amplification by Stimulated Emission of Radiation	The laser is an intense light source. Light from a laser is all the same frequency, unlike the output of an incandescent bulb. Laser light is typically coherent and has a high energy density.
Laser Diode	A gallium-arsenide semiconductor type of laser connected to a power source to generate a laser beam. This laser type is a compact source of coherent light.
Laser Scanner	An optical bar code reading device using a coherent laser light beam as its source of illumination.
LED Indicator	A semiconductor diode (LED - Light Emitting Diode) used as an indicator, often in digital displays. The semiconductor uses applied voltage to produce light of a certain frequency determined by the semiconductor's particular chemical composition.
Master	The first Bluetooth device initiating the radio connection (Discovery procedure).
Matrix Symbols	A 2-dimensional array of regular polygon shaped cells where the center-to-center distance of adjacent elements is uniform. The arrangement of the cells represents data and/or symbology functions. Matrix symbols may include recognition patterns that do not follow the same rule as the other elements within the symbol (i.e., Data Matrix and MaxiCode).
MIL	1 mil = 1 thousandth of an inch; a unit of measure often used to quantify bar code printing and scanning dimensions.
Misread (Misdecode)	A condition which occurs when the data output of a reader or interface controller does not agree with the data encoded within a bar code symbol.

Module	(1) The narrowest nominal width unit of measure in a symbol. In certain symbologies, element widths are specified as multiples of 1 module. Equivalent to X dimension; or (2) a single cell in a matrix symbology used to encode 1 bit of data. In MaxiCode, the module shape is a regular hexagon. In Data Matrix, the module shape is nominally square. In PDF-417, the module shape is a regular rectangle. In bar code symbologies, the module shape is a regular rectangle.
Module Check Digit or Character	A character within the symbol data field calculated using modular arithmetic that is used for error detection. The calculated character is determined by applying a code algorithm to the data field contents (see Check Digit).
Moving Beam Bar Code Reader	A device where scanning motion is achieved by mechanically moving the optical geometry.
MRD	Minimum reflectance difference: a formula that is used to determine if there is an adequate difference between absorbed and reflected light.
MSI	Based on the original Plessey Code, MSI, also known as Modified Plessey, is a continuous, non-self-checking symbology used to mark retail shelves for inventory control.
Nanometer	Unit of measure used to define the wavelength of light that is equal to 10 ⁻⁹ meter.
Nominal	The exact (or ideal) intended value for a specified parameter. Tolerances are specified as positive and negative deviations from this value.
Nominal Size	Standard size for a bar code symbol. Most UPC/EAN codes are used over a range of magnifications (e.g., from 0.80 to 2.00 of nominal).
Non-Contact Reader/Scanner	Bar code readers requiring no physical contact with the printed symbol.
Non-read	The absence of data at the scanner output after an attempted scan, which is due to no code, defective code, scanner failure or operator error.
Omnidirectional	Bar codes read in any orientation relative to the scanner.
Optical Throw	The distance from the scanner face to the closest point at which symbol can be read; also, optical throw is the difference between range and depth of field.
Orientation	The alignment of the symbol's scan path. Two possible orientations are horizontal with vertical bars and spaces (picket fence) and vertical with horizontal bars and spaces (ladder).
Overhead	The fixed number of characters required for start, stop and checking in a given symbol. For example, a symbol requiring a start, stop and 2 check characters contains 4 characters of overhead.
Pairing	A wireless connection between the cordless scanner and the cradle established by scanning a pairing bar code.
Parameter	A variable that can have different values assigned to it.

PDF-417	An error correcting 2-dimensional multi-row symbol developed in 1992 by Symbol Technologies, PDF-417 symbols are constructed from 4 bars and 4 spaces over 17 modules. The symbol size is from 3 to 90 rows. There is no specified minimum or maximum for X or Y dimension. With at least the recommended minimum level of error correction, the recommended Y dimension is 3X. With less than the minimum recommended level of error correction, the recommended Y dimension is 4X. A quiet zone of 2X is specified on each side of a symbol. Because of delta decode techniques, the symbology is immune from uniform bar width growth. PDF-417 supports cross-row scanning. The intellectual property rights associated with PDF-417 have been committed to the public domain.
Percent Decode	The average probability that a single scan of a bar code would result in a successful decode. In a well-designed bar code scanning system, that probability should approach near 100%.
Piconet	Bluetooth device network where a Master can communicate with up to seven Slaves.
Pitch	Rotation of a bar code symbol in an axis parallel to the direction of the bars.
Plessey Code	A pulse-width, modulated bar code commonly used for shelf marking in grocery stores.
Postnet Code	Code developed by the U.S. Postal Service to assist in the automatic sorting of mail.
Print Contrast Signal (PCS)	Measurement of the contrast (brightness difference) between the bars and spaces of a symbol. A minimum PCS value is needed for a bar code symbol to be scannable. $PCS = (RL - RD) / RL$, where RL is the reflectance factor of the background and RD the reflectance factor of the dark bars.
Programming Mode	The state in which a scanner is configured for parameter values (see Scanning Mode).
Quiet Zone	A clear space, containing no dark marks, which precedes the start character of a bar code symbol and follows the stop character.
Radio Frequency	Non-optical automatic identification devices that use radio waves to transmit data.
Radio Frequency Data Communication (RFDC)	Handheld or vehicle mounted units that send and receive messages by radio frequency. Information from the units is displayed on a screen for workers and allows real-time, two-way exchange of data between terminals when one terminal is mobile and the other is a host computer at a remote location.
Radio Frequency Identification (RFID)	The use of small radio transponders that are activated by a reading transmitter. The transponder carries a unique ID code or other information in its memory and can be read at a distance without line of sight.
Radio Frequency Tag	An electronic tag capable of receiving, storing and/or transmitting digital information.

Reflectance	Amount of light returned from an illuminated surface.
Remote Bluetooth Device	Any Bluetooth device the reader can communicate with.
Resolution	The narrowest element dimension which is distinguished by a particular reading device or printed with a particular device or method.
RSS	Reduced Space Symbology: A family of space efficient symbologies developed by UCC.EAN.
Scan Area	Area intended to contain a symbol.
Scanner	An electronic device used to scan bar code symbols and produce a digitized pattern that corresponds to the bars and spaces of the symbol. Its three main components are: <ol style="list-style-type: none">1. Light source (laser or photoelectric cell) - illuminates a bar code.2. Photodetector - registers the difference in reflected light (more light reflected from spaces).3. Signal conditioning circuit - transforms optical detector output into a digitized bar pattern.
Scanning Mode	The scanner is energized, programmed, and ready to read a bar code.
Scanning Sequence	A method of programming or configuring parameters for a bar code reading system by scanning bar code menus.
Self-Checking Code	A symbology that uses a checking algorithm to detect encoding errors within the characters of a bar code symbol.
Skew	Rotation of a bar code symbol on an axis parallel to the symbol's length.
Slave	A Bluetooth device which can only wait for a Bluetooth Master device to initiate a connection with it.
Space	The lighter element of a bar code formed by the background between bars.
Space Width	The thickness of a space measured from the edge closest to the symbol start character to the trailing edge of the same space.
Specular Reflection	The mirror-like direct reflection of light from a surface, which can cause difficulty decoding a bar code.
SPP	Serial Port Profile. Bluetooth profile creating an RS232 cable replacement.
Stacked Symbol (2D Symbols)	A 2-dimensional (2D) symbol with sequences of linear (width-coded) data that are stacked one upon another (i.e., PDF-417).
Start/Stop Character	A pattern of bars and spaces that provides the scanner with start and stop reading instructions and scanning direction. The start and stop characters are normally to the left and right margins of a horizontal code.
Substrate	A foundation material on which a substance or image is placed.

Symbol	A scannable unit that encodes data within the conventions of a certain symbology, usually including start/stop characters, quiet zones, data characters, and check characters.
Symbol Aspect Ratio	The ratio of symbol height to symbol width.
Symbol Density	The number of data characters per unit length; usually expressed as characters per inch (CPI).
Symbol Height	The distance between the outside edges of the quiet zones of the first row and the last row.
Symbol Length	Length of symbol measured from the beginning of the quiet zone (margin) adjacent to the start character to the end of the quiet zone (margin) adjacent to a stop character.
Symbology	The structural rules and conventions for representing data within a particular bar code type (e.g. UPC/EAN, Code 39).
Tilt	Rotation of a bar code symbol on an axis perpendicular to the substrate.
Tolerance	Allowable deviation from the nominal bar or space width.
2-dimensional (2D) symbology	A machine-readable symbol which must be examined both vertically and horizontally to read the entire message. A 2D symbol may be one of two types of machine-readable symbols: a Matrix Symbol or a stacked symbol. 2D symbols differ from linear bar codes with the ability for high data content, small size, data efficiency and error correction capability.
UCC	Uniform Code Council: the organization that administers the U.P.C and other retail standards.
UCC.EAN-128	Code 128 with a Function 1 character in the first position that is the symbology used with the UCC.EAN format for a universal product number (UPN).
UPC	Universal Product Code. A relatively complex numeric symbology. Each character consists of two bars and two spaces, each of which is any of four widths. The standard symbology for retail food packages in the United States.
Variable Length Code	A code with a number of encoded characters within a range, as opposed to a code with a fixed number of encoded characters.
Vertical Bar Code	A bar code pattern presented in such orientation that the symbol from start to stop is perpendicular to the horizon. The individual bars are in an array appearing as rungs of a ladder.
Visible Laser Diode (VLD)	A solid state device which produces visible laser light.
Wand Scanner	A handheld scanning device used as a contact bar code or OCR reader.
Wedge	A device that plugs in between a keyboard and a terminal and allows data to be entered by a keyboard or by various types of scanners.

X Dimension

The dimension of the narrowest bar and narrowest space in a bar code.

Y Dimension

The height of the modules in a row of a 2-dimensional symbols.

Numerics

123Scan configuration 12-3

A

accessories 1-14

ADF

invalid rule 3-4

rules 10-9, 12-3

transmit error 3-4

advanced data formatting 3-4, 10-9, 12-3

aiming 2-6

ASCII values

keyboard wedge 6-14

RS-232 7-19

standard defaults F-1

USB 8-14

assembling the stand 2-8

authentication 4-14, 4-31, A-2, 1-1

auto-reconnect 2-9, 4-16, 4-24, 4-26, 4-28

B

bar code defaults

all A-1

IBM 9-5

keyboard wedge 6-5

radio communication 4-14

RS-232 7-5

scanner emulation 11-5

symbolologies 13-6

USB 8-5

user preferences 5-4

wand emulation 10-5

bar codes

123Scan 12-3

auto-reconnect 4-24

batch mode 5-15, 5-16

beep after good decode 5-10

beeper tone 5-6

beeper volume 5-6

Bluetooth technology support 4-18

cancel D-4

FN1 sub values 5-13

IBM 468X/469X

convert unknown to code 39 9-7

port address 9-6

keyboard wedge

alternate numeric

keypad emulation 6-10

caps lock on 6-10

caps lock override 6-10

country keyboard types

(country codes)	6-7
host types	6-6
ignore unknown characters	6-8
intra-keystroke delay	6-9
keystroke delay	6-9
laser on time	5-9
numeric bar codes	D-4
parameter broadcast	4-26
power mode	5-7
prefix/suffix values	5-11
radio output power	4-26
RS-232	
baud rate	7-9
beep on	7-16
check receive errors	7-12
data bits	7-11
hardware handshaking	7-12
host serial response time-out	7-15
host types	7-8
ignore unknown characters	7-18
intercharacter delay	7-17
Nixdorf Beep/LED options	7-18
RTS line state	7-16
stop bit select	7-11
RS-232 parameters	
parity	7-10
scan data transmission format	5-11
scan line width	5-9
scan patterns	5-8
scanner to cradle support	4-25
set defaults	5-5
symbolologies	
bi-directional redundancy	13-51
bookland EAN, enable/disable	13-11
Chinese 2 of 5, enable/disable	13-39
codabar CLSI editing	13-41
codabar lengths	13-40
codabar NOTIS editing	13-42
codabar, enable/disable	13-40
code 11 check digit verification	13-33
code 11 lengths	13-31
code 11 transmit check digits	13-33
code 128 enable/disable	13-19
code 39 buffering	13-25
code 39 check digit verification	13-24
code 39 full ASCII conversion	13-25
code 39 lengths	13-23
code 39 transmit buffer	13-27
code 39 transmit check digit	13-24
code 39, enable/disable	13-21
code 93 lengths	13-29
code 93, enable/disable	13-29
convert UPC-E to UPC-A	13-16
convert UPC-E1 to UPC-A	13-17
discrete 2 of 5 lengths	13-37
discrete 2 of 5, enable/disable	13-37
EAN-13/EAN-8, enable/disable	13-10
EAN-8/JAN-8 extend	13-17
I 2 of 5 check digit verification	13-35
I 2 of 5 convert to EAN-13	13-36
I 2 of 5 lengths	13-34
I 2 of 5 transmit check digit	13-36
I 2 of 5, enable/disable	13-34
intercharacter gap	13-52
ISBT 128, enable/disable	13-20
MSI check digit algorithm	13-45
MSI check digits	13-44
MSI lengths	13-43
MSI transmit check digits	13-45
MSI, enable/disable	13-43
redundancy levels	13-48
RSS, convert to UPC/EAN	13-47
RSS, enable/disable	13-46
security levels	13-50, 13-51
supplementals	13-11
trioptic code 39, enable/disable	13-21
UCC coupon extended code	13-18
UCC/EAN-128, enable/disable	13-19
UPC-A preamble	13-14
UPC-A transmit check digit	13-13
UPC-A/UPC-E, enable/disable	13-9
UPC-E preamble	13-15
UPC-E transmit check digit	13-13
UPC-E1 preamble	13-16
UPC-E1 transmit check digit	13-14
UPC-E1, enable/disable	13-10
UPC/EAN/JAN	
supplemental redundancy	13-13
synapse interface	5-14
time delay to reduced power mode	5-7, 5-8
transmit code ID character	5-10
transmit no read message	5-13
unpair	4-28
USB	
caps lock override	8-9
country keyboard types	8-7
device type	8-6
keystroke delay	8-9
unknown characters	8-10
wand emulation	
code 39 full ASCII	10-10
convert all bar codes to code 39	10-9
host types	10-6
leading margin (quiet zone)	10-7
polarity	10-8
unknown characters	10-8
bar codes RS-232	
software handshaking	7-14
battery	
charging	1-12
inserting/removing	1-11
beeper definitions	
pairing	4-15
standard	2-3
wireless	4-15
Bluetooth	1-8, 1-13
Bluetooth disconnect event	2-3, 3-4, 4-15
Bluetooth security	4-31

C

- cables
 - installing 1-8
- character set 6-14, 7-19, 8-14, F-1
- charging 1-12
 - LEDs 1-12
 - via USB 1-9
- charging LED 2-4
- Chinese 2 of 5 bar codes 13-39
- codabar bar codes 13-40
- code 11 bar codes 13-31
- code 128 bar codes 13-19
- code 39 bar codes 13-21
- code 93 bar codes 13-29
- code identifiers
 - AIM code IDs B-4
 - Symbol code IDs B-3
- configuring scanner 1-13
- cradle 1-8
 - connecting 1-8
 - diagram 1-6, 1-7
 - inserting scanner 1-12
 - mounting 1-10
 - pinouts 3-10
 - supply power 1-9
- cradle parts 1-6, 1-7

D

- decode zone 2-11
- default parameters
 - all A-1
 - IBM 9-5
 - keyboard wedge 6-5
 - radio communication 4-14
 - RS-232 7-5
 - scanner emulation 11-5
 - standard default table F-1
 - symbolologies 13-6
 - USB 8-5
 - user preferences 5-4
 - wand emulation 10-5
- discrete 2 of 5 bar codes 13-37
- DTF bar codes 13-37

E

- encryption 4-14, 4-32, A-2, 1-6

error indications

- ack/nak 7-14
- ADF 3-4
- beeper 5-10
- enq 7-14
- format 3-5
- input 3-4
- laser on time 5-9
- miscellaneous scanner options 4-13
- RS-232 3-4
- RS-232 transmission 7-12
- symbolologies 13-5
- transmission 3-5, 7-15
- unknown characters 6-8, 7-18, 8-10
- user preferences 5-3
- xon/xoff 7-14

H

- HID Profile 4-30
- HID Profile master 4-16, 4-24, 4-26
- HID Profile slave 4-16
- host types
 - IBM (port address) 9-6
 - keyboard wedge 6-6
 - RS-232 7-8
 - scanner emulation 11-6
 - USB 8-6
 - wand emulation 10-6

I

- IBM 468X/469X connection 9-4
- IBM 468X/469X parameters 9-6
- IBM defaults 9-5
- information, service xvi
- inserting battery 1-11
- intellistand 2-8, 2-9
- intercharacter gap 13-52
- interleaved 2 of 5 bar codes 13-34

K

- keyboard wedge connection 6-4
- keyboard wedge defaults 6-5
- keyboard wedge parameters 6-6

L

- LED
 - charging 2-4
 - definitions 2-4
 - scanning 2-4
- lock override 4-26, 4-27
- locked pairing mode 4-26, 4-28

M

- maintenance 3-3
- master 2-9, 3-4, 4-16, 4-24, 4-26, 4-30, 1-9, 1-10

mounting
 cradle1-10
 MSI bar codes13-43
 multipoint-to-point communication4-25

N

notational conventions xv
 NW - 713-40

P

pairing
 address4-24
 bar code1-6, 2-3, 4-15
 bar code format4-30
 charging cradle1-8
 connection maintenance interval4-28
 cradle host4-16
 HID4-16
 intellistand2-9
 lock override4-27
 lost connection to host1-10
 master3-4
 master/slave setup4-30
 methods4-27
 modes4-14, 4-26
 multipoint-to-point4-25
 on contacts4-14
 pin codes4-31
 point-to-point4-25
 radio communication1-13
 SPP4-16
 troubleshooting3-5
 unpair4-26, 4-28
 pairing beeper definitions4-15
 pairing modes
 locked4-28
 parameter defaults
 allA-1
 IBM9-5
 keyboard wedge6-5
 radio communication4-14
 RS-2327-5
 scanner emulation11-5
 symbolologies13-6
 USB8-5
 user preferences5-4
 wand emulation10-5

parameters
 batch mode5-15, 5-16
 beep after good decode5-10
 beeper tone5-6
 beeper volume5-6
 Bluetooth technology support4-18
 FN1 sub values5-13
 IBM 468X/469X9-6
 keyboard wedge6-6
 laser on time5-9
 power mode5-7
 prefix/suffix values5-11
 radio communication4-16, 4-17
 auto-reconnect4-24
 batch mode5-15, 5-16
 connection maintenance interval4-28
 host types4-16, 4-17
 pairing4-26
 parameter broadcast4-26
 RS-2327-6
 scan data transmission format5-11
 scan line width5-9
 scan patterns5-8
 scanner to cradle support4-25
 set defaults5-5
 symbolologies13-6
 synapse interface5-14
 time delay to reduced power mode5-7, 5-8
 transmit code ID character5-10
 transmit no read message5-13
 USB8-6
 wand emulation10-6

parts
 cradle1-6, 1-7
 scanner1-5

pinouts
 cradle signal descriptions3-10
 point-to-point communication4-25
 power1-9
 via USB1-9

Q

quiet zone (leading margin)10-7

R

radio communication
 Bluetooth Technology Profile support1-8, 1-13
 defaults4-14
 multipoint-to-point4-25
 pairing1-13
 parameters4-16, 4-17
 point-to-point4-25
 rastering2-5, 5-8
 removing battery1-11
 replacing battery1-11
 RS-232 connection7-4
 RS-232 defaults7-5
 RS-232 parameters7-6

RSS bar codes
 reduced space symbology 13-46

S

sample bar codes
 code 128 C-3
 code 39 C-3
 interleaved 2 of 5 C-4
 RSS C-4
 UPC/EAN C-3

scan patterns
 multi-line rastering 2-5, 5-8
 rastering 5-8
 single line 2-5, 5-8

scanner emulation defaults 11-5

scanner parts 1-5

scanner to cradle support 4-25

scanner(s) to cradle support 4-25

scanning
 aiming 2-6
 errors 6-8, 8-10
 hand-held 2-5
 hand-held mode 2-5
 hands-free 2-8, 2-9
 radio communications sequence example 4-13
 symbologies sequence example 13-5
 user preferences sequence example 5-3

scanning LED 2-4

security level bar codes
 bi-directional redundancy 13-51

security levels 13-48, 13-50

Serial Port Profile 4-30

Serial Port Profile master 4-16, 4-24, 4-26

Serial Port Profile slave 4-16

service information xvi

setup
 connecting a USB interface 8-4
 connecting an RS-232 interface 7-4
 connecting keyboard wedge interface 6-4
 connecting to an IBM 468X/469X host 9-4
 connecting using wand emulation 10-4, 11-4

cradle 1-8
 inserting scanner in cradle 1-12
 installing the cable 1-8
 mounting cradle 1-10
 scanner 1-8
 supplying power 1-9
 synapse 1-10
 unpacking 1-4

signal descriptions 3-10

slave 3-4, 4-16, 4-30, 1-9, 1-10

specifications 3-7

SPP 4-30

SPP master 4-16, 4-24, 4-26

SPP slave 4-16

stand
 assembling 2-8

standard default parameters F-1

Symbol support center xvi

symbologies defaults 13-6

synapse 1-10

T

technical specifications 3-7

troubleshooting 3-4

U

unlocked pairing mode 4-26

unpacking 1-4

unpairing
 bar code 4-28

UPC/EAN bar codes 13-9

USB connection 8-4

USB defaults 8-5

USB parameters 8-6

user preferences bar codes
 batch mode 5-15, 5-16
 beep after good decode 5-10
 beeper tone 5-6
 beeper volume 5-6
 FN1 sub values 5-13
 laser on time 5-9
 power mode 5-7
 prefix/suffix values 5-11
 scan data transmission format 5-11
 scan line width 5-9
 scan patterns 5-8
 set defaults 5-5
 synapse interface 5-14
 time delay to reduced power mode 5-7, 5-8
 transmit code ID character 5-10
 transmit no read message 5-13

user preferences defaults 5-4

W

wand emulation connection 10-4, 11-4

wand emulation defaults 10-5

wand emulation parameters 10-6

Symbol Technologies, Inc.
One Symbol Plaza
Holtsville, New York 11742-1300
<http://www.symbol.com>



72E-69834-01 Revision A
November 2005