

pidion

www.mypidion.com



# BIP-6000 Manual



Mobile

Barcode

PC-Sync

- Please read the following warnings before using the product.
- Shapes and colors of the images shown in this manual may differ from the actual products.
- Contents of the manuals may differ based on the software version of products or conditions of the wireless provider.

## Copyright

- This User's Manual is protected under the related copyright laws.
- This User's Manual is produced by Bluebird Soft Inc. The company has made every effort to avoid errors and omissions. Please understand that some parts may not reflect the actual state.
- The supplied basic programs are protected under. Reproduction, transfer or deletion of the programs without prior consent is strictly prohibited.
- Depending on users' environments, programs or peripherals, some parts of this Product may not work normally.
- This wireless device may cause propagation interference, and so, it cannot be used for life-saving services.

## Trademark



PIDION aims for leading brand in the future mobile industry. As a global brand representing the image of reliability, representativeness, and cutting-edge technologies, this mark has been registered by Bluebird Soft Inc. around the world to be protected under trademark-related laws.

## User's guidance

Device type	User's guidance
A-level (IT device at work)	This device is registered as suitable for electromagnetic wave use at workplace. It should be appropriately considered by dealers or users. If you sell or buy this device by mistake, please replace it with a product for home use.
Type registration	This wireless device may cause propagation interference, and so, it cannot be used for life-saving services.

※ Please read warnings and cautions before use.

# Contents

BIP-6000

- 2 Knowing the product**
- 3 Safety Instructions I**
- 4 Safety Instructions II**
- 5 About the product**
  - 1. Checking components
  - 2. Checking names of parts
  - 3. Buttons
  - 4. Features
  - 5. Communication spec.
- 12 Learning basics**
  - 1. Mounting/Dismounting battery
  - 2. Inserting/Removing USIM/USAM card
  - 3. Setting password
  - 4. Inserting/removing MicroSD card
  - 5. Charging a terminal with a desktop charger
  - 6. About battery
  - 7. Switching On/Off power
- 8. Communication status indication**
- 9. Adjusting screen**
- 10. Using stylus pen**
- 11. Using earjack**
- 12. Resetting terminal**
- 13. Hard-resetting**
- 14. Using IrDA**
- 24 Using USB cable**
- 25 Connecting ActiveSync**
  - 1. Installing ActiveSync
  - 2. Using ActiveSync
- 30 Using barcode reader**
  - 1. Using barcode
  - 2. Scanning barcode
  - 3. Reading barcode
- 32 Today Screen**
  - 1. Viewing Today Screen
  - 2. Setting photo image as the background image
  - 3. Adjusting volume
  - 4. Checking battery
- 34 Inputting text**
  - 1. Selecting Text Input Mode
  - 2. Block Recognizer
  - 3. Key Pad
  - 4. Keyboard
  - 5. Letter Recognizer
  - 6. Transcriber
- 37 Phone program**
  - 1. Making a call
  - 2. Receiving a call
  - 3. Rejecting calls
  - 4. Ending calls
- 39 Phonebook**
  - 1. Searching phonebook
  - 2. Registering entry
  - 3. Viewing menu
- 42 Text Message**
  - 1. Creating a Text Message
  - 2. Sending a Text Message
  - 3. Viewing Text Messages
  - 4. Managing Draft Messages
- 5. Managing Deleted Items**
- 6. Managing Sent Messages**
- 45 Camera**
  - 1. Taking photos
  - 2. Viewing album
- 48 Settings**
  - 1. Setting personal environment
  - 2. Setting system environment
  - 3. Setting connection environment
- 63 Q & A**
- 64 Customer Service**
- 65 Service Center Information**
- 67 Warranty Certificate**

## Knowing the product

### **FCC RF EXPOSURE INFORMATION**

#### ***WARNING! Read this information before using your phone***

In August 1996 the Federal Communications Commission (FCC) of the United States with its action in Report and Order FCC 96-326 adopted an updated safety standard for human exposure to radio frequency (RF) electromagnetic energy emitted by FCC regulated transmitters.

Those guidelines are consistent with the safety standard previously set by both U.S. and international standards bodies. The design of this phone complies with the FCC guidelines and these international standards.

**CAUTION :** Use only the supplied or an approved antenna. Unauthorized antennas, modifications, or attachments could impair call quality, damage the phone, or result in violation of FCC regulations. Do not use the phone with a damaged antenna. If a damaged antenna comes into contact with the skin, a minor burn may result. Please contact your local dealer for replacement antenna.

#### **Body-worn Operation**

This device was tested for typical body-worn operations with the back of the phone kept 1.5 cm. from the body.

SAR compliance for body-worn operation is restricted to belt-chips, holsters or similar accessories that have no metallic component in the assembly.

The SAR limit of USA (FCC) is 1.6 W/kg averaged over one gram of tissue.

BIP-6000 Device(FCC ID : SS4P1770) has also been tested against this SAR limit. The highest SAR value reported under this standard during product certification for use at the ear 0.424W/kg and when properly worn on the body is 0.289 W/kg.

#### **WARNING**

Any changes or modification not expressly approved by the party responsible could void the user's authority to operate the device.

## Safety Instructions I

BIP-6000

Read these instructions and warnings to use the Product in a safe manner and to prevent accidents.

### Cautions in relation with batteries

- Batteries may explode when damaged, impacted, heated, flooded or taken apart with a gimlet. Make sure to keep the batteries out of reach of children or pets.
- Do not use the Product in the area with the risk of explosion.
- If the Product is wet, do not put it in a device that may heat the terminal (heater, microwave oven, etc.). Heating batteries may cause an explosion, deformation or fault. (Water or any other liquid will change the color of the label inside the terminal. In this case, no warranty service will be provided.)

### Safety Guideline

- Do not use the Product on an airplane or in a hospital.
- Do not operate the Product or search a phone number while driving a car. If it is unavoidable, please use a hands-free kit or stop the car.
- Batteries may become deformed and get in trouble if they are left in a hot and sealed place such as on a dashboard of a car under the direct sun light.

- Make sure that battery terminals (metal part) should not contact with any conductive materials like a necklace or coin. Also make sure that batteries should not be damaged by teeth or a nail. Impact may cause an explosion of batteries.
- Use dedicated batteries only and do not use the batteries for any other purpose than operating this Product. Using an inauthentic battery may reduce life of the Product, or cause an explosion. (In this case, no warranty service will be provided.)
- Make sure to use the adapter or the standard charger supplied with this Product. Using an inauthentic charger may reduce life of batteries or cause an explosion. (In this case, no warranty service will be provided.)

### Caution in relation with Laser Scanner



Do not flashing scanner light in human and animal's eyes. It could cause the damage of retina and amblyopia.

## Safety Instructions II

Read these instructions carefully to keep yourself safe and to avoid loss of property.

1. This Product is EMC-compliant. For safety and health, use the authentic parts supplied by the manufacturer. Any inauthentic part may affect safety.
2. Do not press the power button when the Product is wet. Touching the adapter or power cord with wet hands may cause an electric shock.
3. Do not modify, disassemble or repair the Product at your discretion. Manufactor if there is a problem in the Product. Also, make sure to follow the warnings and Instructions. If you fail to follow any of the above instructions, no warranty service will be provided.
4. Record the data in the Product and keep it in a separate place. Data stored in the Product may be deleted during repairing or upgrading the Product. So, make sure to back up important data. (Bells, text/voice messages and characters are initialized.)
5. Do not use this Product in a hot or humid place. Using the Product under a hot/humid temperature such as rain or sauna may cause a trouble. In this case, no warranty service will be provided.
6. Keep this Product away from magnetic products such as credit card, telephone card, bankbook and traffic ticket. The magnetic field of the terminal may affect the data.
7. Avoid vibration and impact. When not in operation or when you are absent, pull out the power cord, and keep the Product in a safe place.
8. Avoid any dusty place, and keep the power cord away from any heating device. When cleaning the Product, pull out the power cord first. Dust off the pins of the power plug.
9. When storing a battery for a long period of time, recharge it and keep it at a room temperature. Even a fully charged battery will suffer reduced life due to the characteristics of the battery.
10. Painting this Product may damage appearance or display, or may cause a fault. Peeled-off paint may cause allergies depending on the physical conditions. In this case, stop using the Product and see a doctor.

## About the product

BIP-6000

### 1 Checking components

The images in this User's Manual may not reflect the color and shape of the actual product. Please contact the Customer Care Center if you wish to purchase any additional or optional products.



[ BIP-6000 Main Body ]

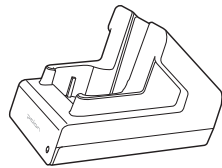

[ Desktop Cradle ]



[ Battery ]

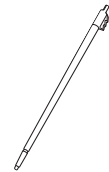

[ Stylus Pen ]

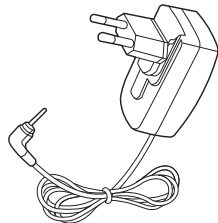

[ Adapter ]

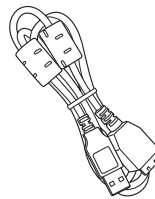

[ USB cable ]

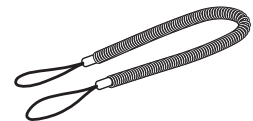

[ Spring Wire ]



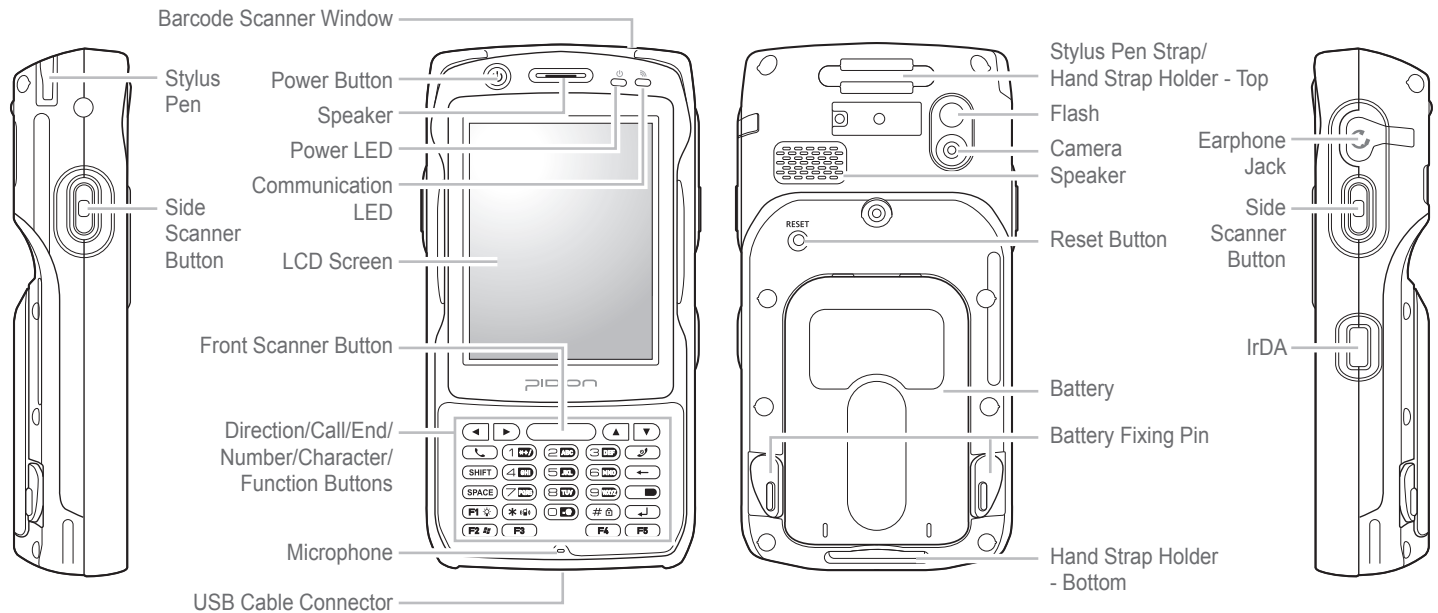

## About the product



### 2 Checking names of parts





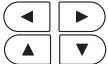

### 3 Buttons



Button	Description
	<b>Power button</b> Used to switch On/Off the terminal.
	<b>Barcode buttons (Right/Left)</b> Used to operate the barcode functions.  <b>During a call</b> Used to adjust call volume during a call. (Right : Volume up / Left : Volume down)
	<b>Barcode button</b> Used to operate the barcode functions.
	<b>Camera button</b> Press this button during a camera function to take a photo or video.



Button	Description
	<b>Arrow buttons</b> Used to move left/right/up/down.
	<b>Call button</b> Used to start the phone program. If you press this button once while using the phone program, a call is made to the last party in the call list.  Press 'Send' button on the keypad to connect Internet Explore. (WLAN only terminal)
	<b>End button</b> Ends the phone program. You can finish a call by pressing this button during the call. You can also exit an application program. Press and hold (at least 3 sec) this button to switch off the phone function.







## About the product

### 3 Buttons - 2

Button	Description
	<p><b>SHIFT button</b> Used to switch between Lowercase/ Uppercase English alphabet. (The default is Lowercase English.)</p> <p>If you press this button once and then an alphabet key, the uppercase of the key is entered. Then, input mode is switched to the lowercase.</p> <p>If you press this key twice, the input mode is remained in the Uppercase like Caps Lock until you release it.</p> <p>To release the Caps Lock, you need to press the SHIFT key twice.</p>
	<p><b>Space button</b> The cursor moves to the right, leaving an empty space. It works like the Space key in computer.</p>

Button	Description
	<p><b>BKSP button</b> The cursor moves backward, erasing the letters.</p> <p>It works like the Back Space key in computer. If you press and hold (at least 3 sec) this button, the letters are deleted one by one promptly and continuously.</p>
	<p><b>Mode change button</b> Used to switch the input character between Korean/English Uppercase/English Lowercase. If you press the mode switch button in the number mode, English Lowercase alphabets and symbols are displayed.</p> <p>The default is Numeric. Alphabets and symbols are activated until you press the mode change button again.</p>

Button	Description
	<p><b>Light button</b> Press this button to set the Function key. If you press and hold this button for over 2 seconds, the LCD display light is switched On/Off. The Display On or Off status is maintained until you press the button again.</p>
	<p><b>Window button</b> Press this button to enable the function keys. Press and hold this button for over 2 seconds, and the start menu window appears.</p>
	<p><b>* button</b> Press and hold this button for over 3 seconds to switch between Vibration/Ringer modes.</p>

Button	Description
	<p><b># button</b> <b>On the Phone main window, # is entered.</b> <b>On the windows other than the Phone main window, if you press and hold this key, the phone is locked.</b></p>
	<p><b>Enter button</b> Changes lines in the text input mode. This button works like the Enter key in computer.</p>
    	<p><b>F1 ~ F5 buttons</b> You can define the functions. See p.48 for details.</p>

## About the product

### 3 Buttons - 3

Button	Description
	<p><b>Numeric / Alphabet button</b> The default is Numeric. Used to enter numbers or alphabets.</p>
	<p><b>Reset button</b></p> <p><b>Soft Reset</b> All the programs in use are closed and the system is rebooted.</p> <p><b>Hard Reset</b> The product is initialized.</p>

### 4 Features

Item	Description
CPU	PXA 320, 806MHZ
OS	Windows Mobile 6.1
RAM	256MB
ROM	512MB
DISPLAY	3.5" QVGA TFT-LCD/3.5" VGA TFT-LCD
INTERFACE	RS-232, USB 1.1 Host & Client, IRDA
BATTERY	Rechargeable, 3.7V 4400mAh, Li-ion
SIZE	80(W) x 160(H) x 35.5(D)mm
WEIGHT	425g (incl. a hand strap)
ADAPTER	5V 3A

## 5 Communication spec.

Item	Description
WCDMA	Frequency : TX (1922.4MHz~1977.6MHz) RX (2112.4MHz~2167.6MHz) Frequency stability : within $\pm 200$ Hz Antenna power : 250mW Propagation type : G7W, D7W Modulation method : QPSK/BPSK(FDD)
Wireless Lan	Frequency : 2412MHz~2472MHz No. of channels : 13 Antenna power : 10mW/MHz Propagation type : GID, D2D Modulation method : DSSS/CCK(802.11b), CCK/OFDM(802.11g)
Bluetooth	Frequency : 2402MHz~2480MHz No. of channels : 79 Antenna power : 20uW Propagation type : F1D Modulation method: GFSK
13.56MHZ RFID	Frequency : 13.56Mhz

## Learning basics

### 1 Mounting/Dismounting battery

#### Mounting a battery

- ① Place the battery and push in to the arrow direction.
- ② Turn the battery pins inside to fix the battery.

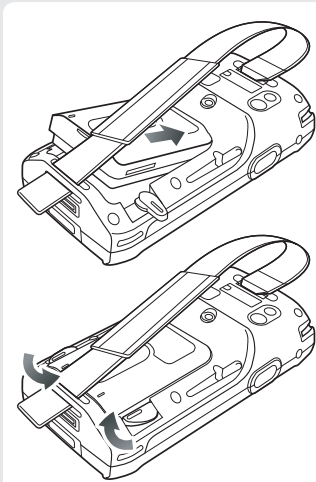

#### Dismounting a battery

- ① Switch off PDA.
- ② Turn the battery pins outside to remove the battery.
- ③ Lift off the battery to the arrow direction.

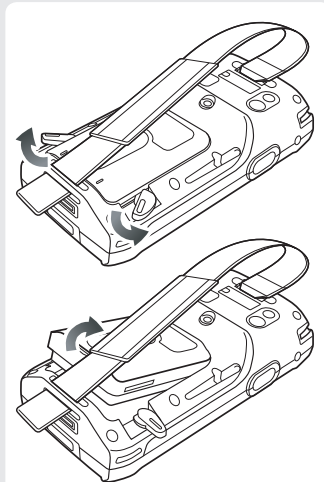

Before removing a battery, make sure to switch off the terminal.  
An abrupt power shutoff may result in a trouble.

## 2 Inserting/Removing USIM/USAM card

### Inserting a USIM/ USAM card

Insert a USIM/USAM  
card to the arrow  
direction.

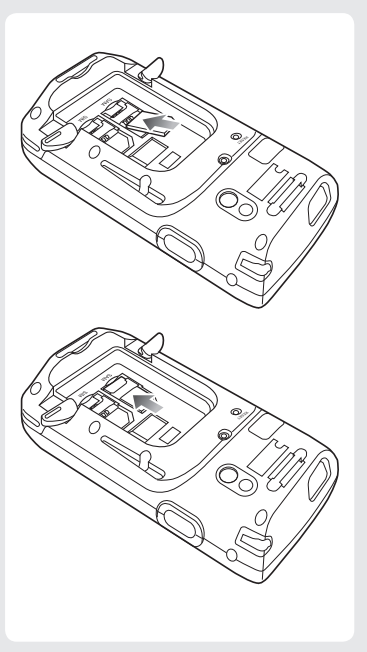

### Removing a USIM/ USAM card

Remove a USIM/USAM  
card to the arrow  
direction.

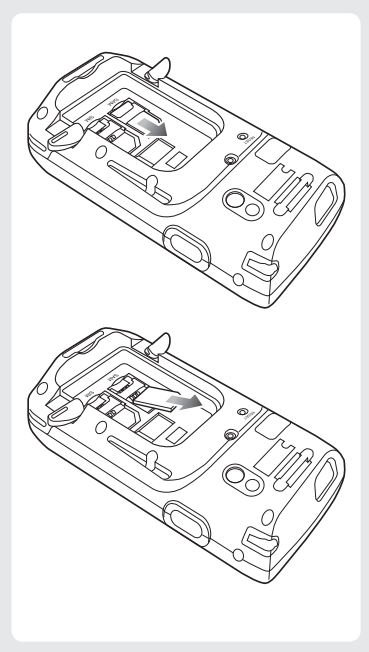

## Learning basics

### 2 Inserting/Removing USIM/USAM card - 2

#### About USIM card?

USIM (Universal Subscriber Identity Module) is a user identification card which is inserted into a W-CDMA phone.

This card integrating the SIM card containing subscriber information and the Universal IC Card (UICC) containing communication and banking function provides various functions including user authentication, global roaming, and e-transaction.

This chip is required for communication with the 3rd generation WCDMA terminals. You can use this card in voice mobile call including international roaming and e-commerce service regardless of type of terminal and communication service provider.

#### About USAM card?

The security application module is equipped in the smart card. Being equipped inside the card reader, it authenticates the card and the terminal, encrypts communication data to protect information, and authorizes and verifies communication messages.

The module stores electronic value transferred from the card, and has the SAM for card authentication in the program for e-commerce.



### 3 Setting password

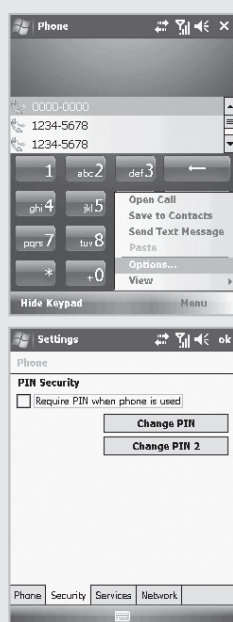

In order to prevent your USIM card from being used by another person, you need to lock your USIM card.

#### Setting a PIN code

**Start** ► **Phone** ► **Menu Tab** ► **Options...** ► **Security Tab**

Click [PIN required for telephone use], enter 4~8 digit-password, and click [ok].

#### Cautions

- PIN code is a password used to protect the data in a USIM card. The default PIN code is <0000>, and you can change it as you like.
- PUK code is an 8-digit code which resets 3 consecutive PIN input errors. The PUK code is written on the envelope or the body of the USIM card. Note that the USIM card is disabled if you enter incorrect PUK codes for 10 consecutive times.
- The USIM card is permanently disabled if you enter incorrect PIN codes for 3 consecutive times or incorrect PUK code for 10 consecutive times. In this case, you need to purchase a new card. Please visit the nearest dealer if you forget your PIN and PUK.

## Learning basics

### 4 Inserting/removing MicroSD card

MicroSD card is a micro flash memory media which is used to store and move data.

#### Inserting MicroSD card

Push in a memory card to the arrow direction on the SD card slot until it is completely inserted.

#### Removing MicroSD card

If you push the memory card in, it springs out. Then, pull out the card.

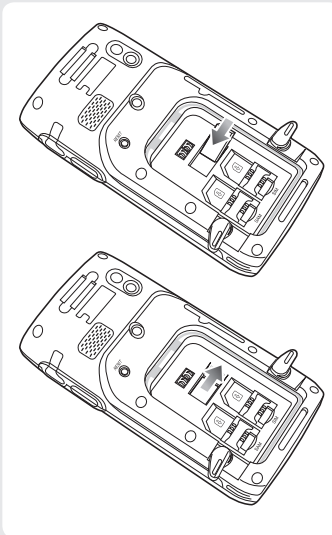

#### Precautions

- Make sure to push in the memory card completely. If it is not inserted completely, the device cannot recognize the memory card.
- In order to remove the memory card, push the inserted memory card once, and the card springs out slightly. Then, pull out the memory card. Applying excessive force to remove the memory card will result in a fault of the device.
- Removing the memory card or shutting power off while using a memory card may result in loss of data, or malfunction of the card and the terminal.
- Make sure to back up critical data in the computer. The manufacturer resumes no responsibility for loss of data in the device.
- If the memory card gets stuck to the device, do not remove the card by force, but visit the nearest after-sales service center. And then, replace or return the card to the dealer from which you purchased the card.

## 5 Charging a terminal with a desktop charger

Place the terminal on the desktop charger, and connect the adapter to the adapter jack on the rear side of the desktop charger.

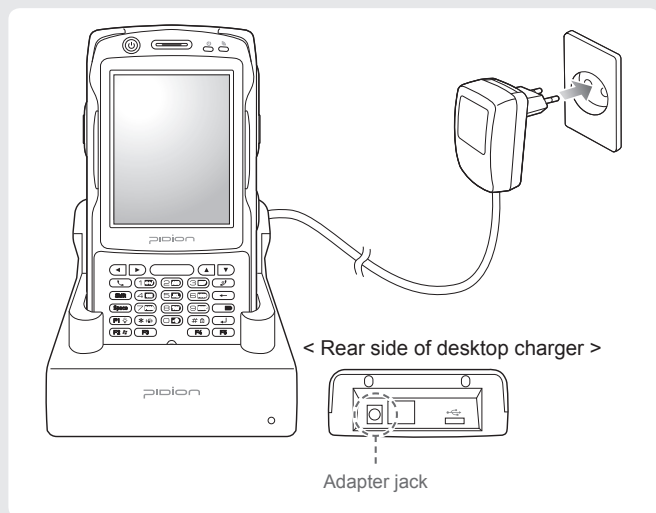

CAUTION

Use the dedicated adapter for maximum safety and effectiveness.

Power cables are sold separately. Please contact the Customer Care Center if you wish to buy one.

## Learning basics

### 6 About battery

- Standby time (extended battery) : at least 168 hours
- Talk time (extended battery) : at least 8 hours
- Capacity (extended battery) : 4400mA



Charging indication lamp

#### Battery operating time

Operating time	Extended battery
Continuous talk time	At least 8 hours
Continuous standby time	At least 168 hours

#### Battery charging time

Charging time	Extended battery
Time	Within 5 hours

※ In order to prevent damage of battery power, the modem is switched off automatically. Please charge the battery.

※ The continuous talk time and standby time are measured under the actual environment, but may vary depending on the usage type.

#### Charging status indication

	In charging	Charging finished
Charging lamp	Red	Green

※ The charging indication lamp on the desktop charger and the terminal are switched to green when charging is finished. The battery will not be damaged if charging is continued.

※ The time required for charging is depending on the charging status. If the charging time gets shorter by half, you need to purchase a new battery.

## 7 Switching On/Off power

You can switch on/off power by pressing the [Power] button on the upper part of the terminal.



## 8 Communication status indication

For the terminals which support WCDMA communication, you can view the GSM or WCDMA 1xEVDO communication status with the [Communication status indication lamp] on the upper right side of the terminal.

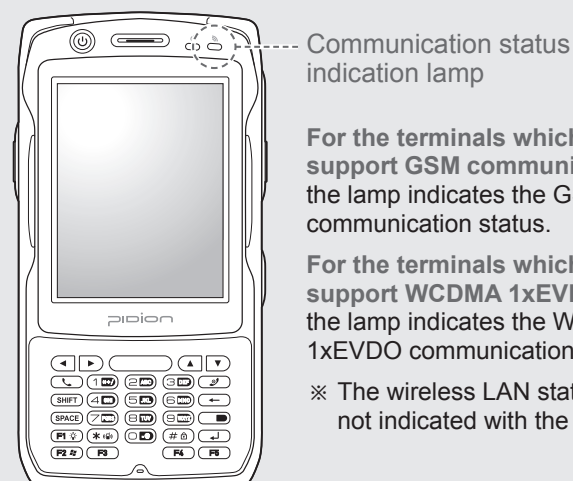

**For the terminals which support GSM communication,** the lamp indicates the GSM communication status.

**For the terminals which support WCDMA 1xEVDO,** the lamp indicates the WCDMA 1xEVDO communication status.

※ The wireless LAN status is not indicated with the lamp.

## Learning basics

### 9 Adjusting screen

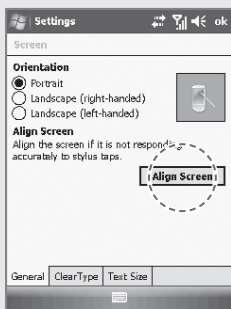

You can set the stylus pen input value on the LCD screen.

#### Setting screen

**Start ▶ Settings ▶ System Tab  
▶ Screen ▶ Align Screen**

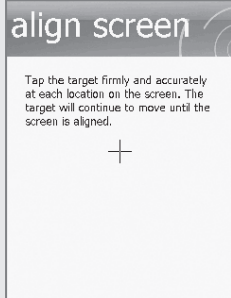

Point the target in the center of the screen with the stylus pen. As the target moves to left top, left bottom, right bottom and right top, point the target accurately.

### 10 Using stylus pen

Use a stylus pen to select/execute/move a target on the screen. The stylus pen is attached in the top right of the terminal.



#### Tap

You can touch icons on the screen with the stylus pen to select or execute the icon as you click the left mouse button.

#### Drag

Used to select multiple items. You can select characters or images as you drag the mouse pointer.

#### Tap and Hold

Used to view the functions of the selected item. If you tap and hold with the stylus pen, a menu pops up as you select an item and click the right mouse button.

## 11 Using earjack

You can use an earphone by removing the earphone cover on the right top of the terminal and inserting the earphone to the jack.

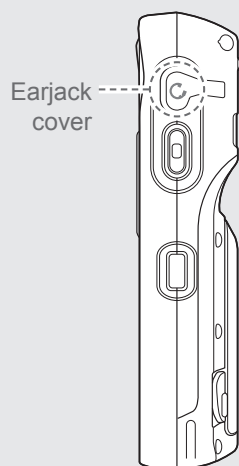

CAUTION

Earjacks are sold as optional items. Please contact the Customer Care Center if you wish to buy one.

## 12 Resetting terminal

Press the [Reset] button on the back of the terminal slightly with the stylus pen.

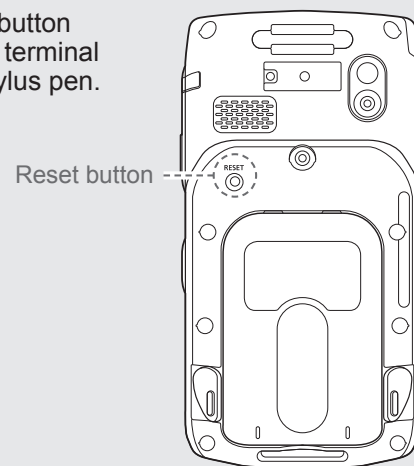



CAUTION

If there is a collision between programs or a program is stopped due to an unexpected situation, you may use the soft reset function. It is like rebooting a computer. Any information that is not saved is lost.

## Learning basics

### 13 Hard-resetting

To hard reset the terminal, you should press the  button and the  button at the same time.

Hard-reset is used when the terminal doesn't respond to soft-reset. Hard-reset initializes the terminal to factory default.



CAUTION

Note that hard-reset deletes all programs, documents and settings in the memory (RAM).

Bluebird Soft assumes no responsibility for loss of data and program. Therefore, you should back up critical data and programs before hard-resetting the terminal.

### 14 Using IrDA

Place the terminals, with IrDA ports facing to each other. (The nearer between the ports, the communication rate increases.)

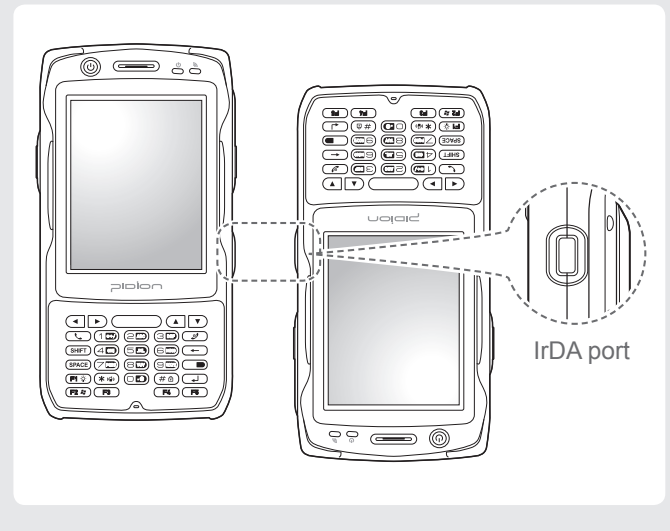



**Procedures of using IrDA port**

- ① Select **Start ▶ Settings ▶ Connections Tab ▶ Wireless Communication**.
- ② Select <Receive all wireless data>, and click [ok].
- ③ Check the data to be sent, and select **Menu ▶ Wireless Communication**.
- ④ Check the corresponding IrDA port and touch the LCD.

## Using USB cable



**Start ► Settings ►  
Connections Tab ► USB to PC**

You can use various USB peripherals connected with the terminal by selecting [Use advanced network function].

This menu is enabled as the peripherals are connected with the terminal through USB cables.



**CAUTION**

[USB to PC] increases consumption of battery power. You can save battery by deselecting this function when you don't use any peripherals.

## Connecting ActiveSync

BIP-6000

### 1 Installing ActiveSync

To connect the terminal with PC, you need to install the [Microsoft ActiveSync] program in your PC.



CAUTION

If the [Microsoft ActiveSync] program is already installed in your PC, you don't need to install the program again.

The screenshots are for the Korean version of [Microsoft ActiveSync 4.5].

The images may vary depending on the version of [Microsoft ActiveSync], but the functions are the same.

- ① Download [Microsoft ActiveSync] from the website of Microsoft, and install the program in the PC.

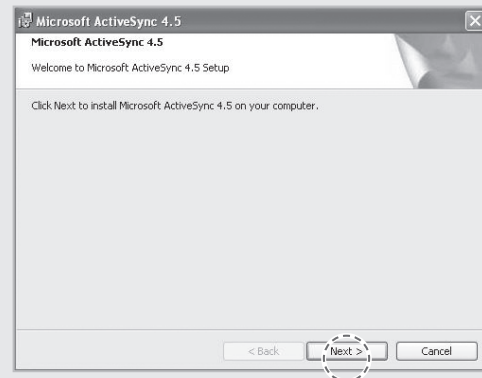

## Connecting ActiveSync

### 1 Installing ActiveSync - 2

- ② On the [License Agreement] window, select <Agree>  
▶ On the [Customer Information] window, fill in the <User Name> and <Company> field ▶ On the [Target Folder] window, select the <Installation Location>.

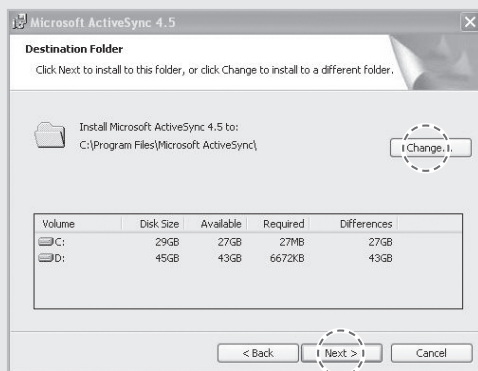

- ③ The [Microsoft ActiveSync] is installed when installation process is ready.

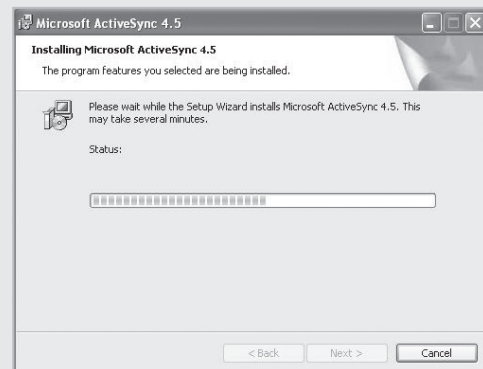

- ④ The [Microsoft ActiveSync] program is installed.

## 2 Using ActiveSync

The screenshots are for the [Windows Mobile] version. The images may vary depending on the version of the software.

Window images for [Windows CE] are different from the samples, but the functions are the same with those of [Windows Mobile].



CAUTION

You must connect the terminal to PC or notebook first to use [MicroSoft ActiveSync]. You can copy/paste files, or install/uninstall programs through synchronization with the terminal.

USB cables are sold separately. Please contact the Customer Care Center if you wish to buy one.

- ① Place the terminal on the desktop charger, and connect the charger or the terminal with the computer through the USB cable.

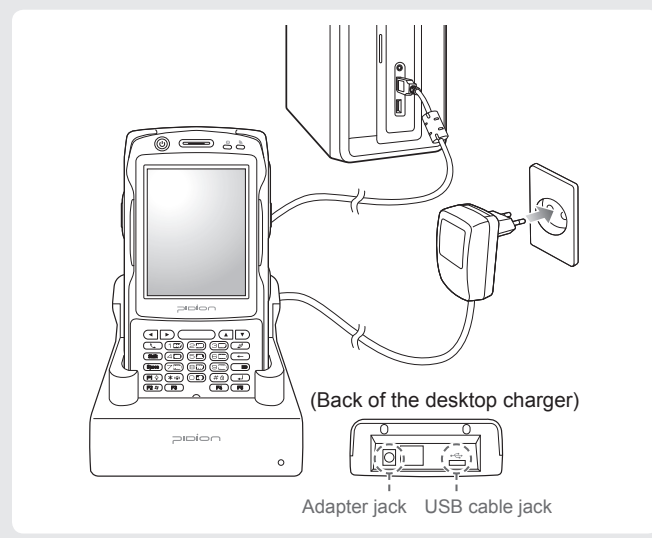

## Connecting ActiveSync

### 2 Using ActiveSync - 2

- ② When the terminal is connected with the computer successfully, the [Microsoft ActiveSync] program is started automatically. Click the [Search] button.



- ③ The <Mobile Devices> folder shows the image, music or document folders in the terminal. You can save the files in the computer.

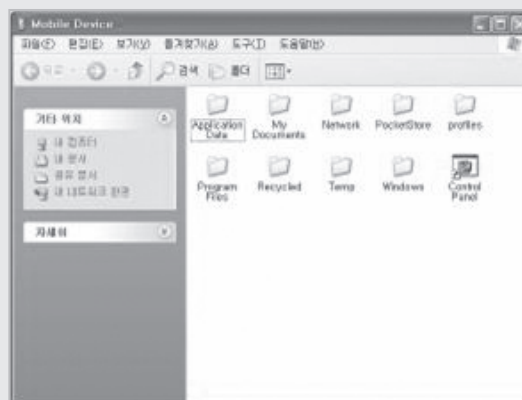

### Precautions in using ActiveSync

#### The message “Unknown Device” pops up after the computer detects the USB device

This message may be displayed when you switch on the terminal as it is mounted on the desktop charger. If you dismount the terminal and then mount it back to the charger, the ActiveSync program works properly.

#### The message “Connecting...” continues

Dismount the terminal from the desktop charger to disconnect it from the computer.



On [ActiveSync], select File ► Set Connection ► <Allow USB Connection>, and then, click [ok]. Connect the terminal again.

#### If connection attempts continue to fail and the message “Unknown Hardware Device” pops up

Abnormal status of the USB host in the computer may result in connection fail. Remove the terminal from the desktop charger, reboot the computer, and then, return the terminal to the desktop charger.

### The terminal does not work when you remove and return the battery

To prevent this problem, you should press the [Power] button or select [Exit] in the Start menu with the stylus pen so that Windows Mobile (or Windows CE) should “Exit System” before you remove the battery.

If you had to remove the battery due to an unavoidable situation, and the terminal does not work properly, press the  button and the  button at the same time for hard-reset.

Note that hard-resetting deletes data from the memory. Only the data in the file storage are preserved.

## Using barcode reader

### 1 Using barcode

You can scan barcodes by pressing the [Barcode] button on the side or front of the terminal.

Barcode button

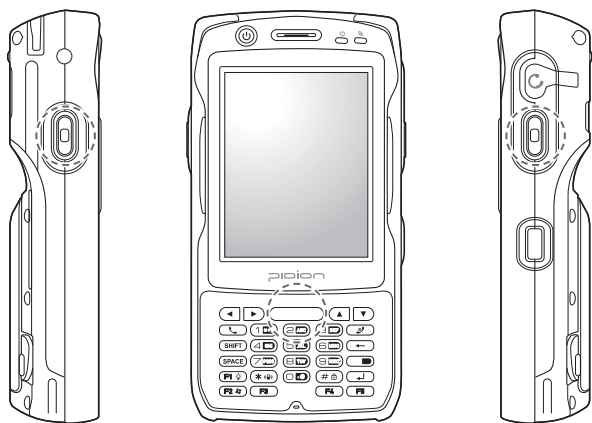

### 2 Scanning barcode

When you scan barcodes, maintain the correct distance (10cm) and angle between a barcode and the barcode scanner window.

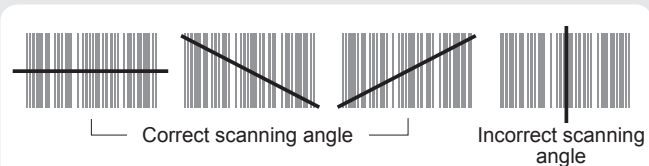

CAUTION

When you use barcodes in a specific program, contact the developer of the program for details.



### 3 Reading barcode

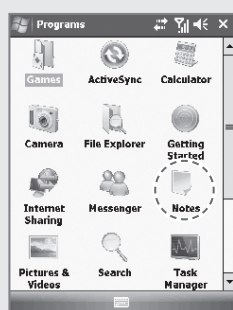

#### Start ► Programs ► Notes

On <Notes>, select [New] button and read a barcode. Then, the barcode data are displayed.

If you read a barcode as <Notes> is open, the barcode is saved automatically in [Notes].

If you read a barcode as <Notes> is shut, because the data is not saved, you should select [New] and [Menu], and then, [Paste].

## Today Screen

### 1 Viewing Today Screen



Terminal states such as [Start], [Wi-Fi], [Com Status], [Volume] and [Battery] are indicated on the top of the screen.

Depending on the settings, [Today Screen] may display [Date], [Time], [Wireless Access Setting], [User Info.], [Message], [Work], [Schedule] or [Lock Status].

See p.50 for details.

You can set the [Start] menu as you like.  
See p.48 for details.



### 2 Setting photo image as the background image

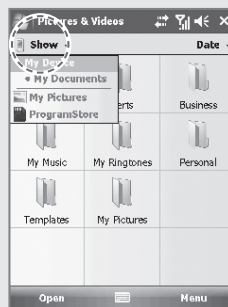

You can set the photo taken by yourself as the background image.

- 1 Select **Start ▶ Programs ▶ Pictures and Videos ▶ Show ▶ My Documents ▶ My Pictures**.
- 2 Select the [Menu] button in the right bottom of the screen.
- 3 Select [Set as Today Background...].
- 4 Select the transparency level of the background image, and select [ok].

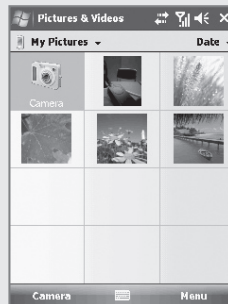

### 3 Adjusting volume

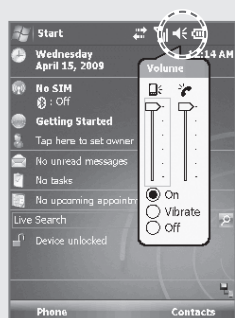



You can adjust volume of the folder/menu selecting tone or the ringer.

Select  in the top right of the screen, select Setting, and you can adjust system/ringer volume.

If you select Vibration, the terminal is switched into the vibration mode. If you select Release, the terminal is switched into the mute mode.

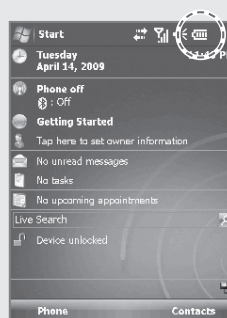
### 4 Checking battery



Select  in the top right of the screen, and you can check the battery status.

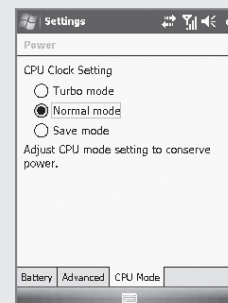
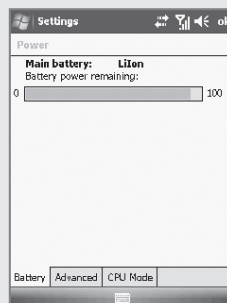

## Inputting text

### 1 Selecting Text Input Mode

There are five different character input methods available.

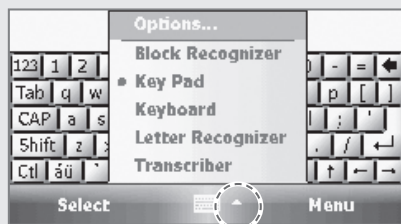

### 2 Block Recognizer

This input method uses the traditional writing area box split in the middle.

The left side is used to write letters and the right side is for number entry.

Symbols and common functions are located in other smaller boxes located in the right of the writing box area.



### 3 Key Pad

Input letter or number by terminal keyboard if choose Key Pad on terminal screen shown as below image.  
See Buttons on page 7~10.

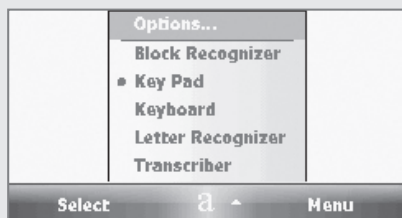

### 4 Keyboard

This input method displays an on-screen keyboard that can be used to input characters by tapping the screen using the stylus pen.



## Inputting text

### 5 Letter Recognizer

This option allows you to enter text using your own handwriting.

The screen is divided into three different areas. A capital letter area, small letter area, and a number area.

Characters are entered by printing letters in each area. The character is then analyzed and typed on the screen automatically.



### 6 Transcriber

The transcriber option is similar to the letter recognizer, except instead of entering characters into a designated area, you can enter entire words and sentences using your own handwriting.

Transcriber supports both printing and cursive writing styles and then automatically types the information on the screen.







## 1 Making a call



Execute the phone program by selecting the [Phone] button, enter a telephone number, and press the [Call] button to make a call.

### Redialing

If you press the [Call] button without entering a phone number, the terminal automatically makes a call to the last call party.

-  : Cancel numbers one by one.
-  : You can make a call with speed dial number. If you select menu in the bottom right of the speed-dial screen, you can add/edit/delete speed-dial numbers. (You can save up to 98 speed-dial numbers.)
-  : You can view the list of received calls/originated calls/missed calls.
-  : Enter a phone number and press this button to make a call.

## 2 Receiving a call

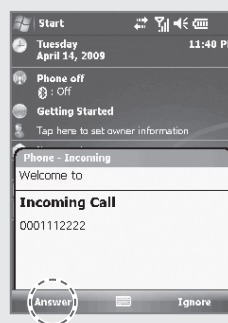

If the terminal rings and a call receiving message is displayed, click the [Call] button or select the [Answer] button in the bottom of the screen.

- ※ The calling party information message can be indicated differently from the one of normal phones.
- ※ The phone functions are the same as the normal phones. Refer to p.21 if you wish to use an earphone.

## Phone program

### 3 Rejecting calls

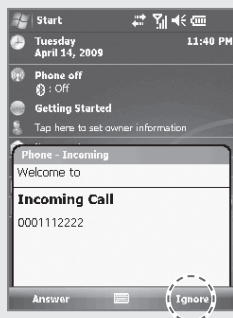

Select the [Ignore] button in the bottom of the screen or press the [End] button on the keypad to cut off an incoming call.

### 4 Ending calls



Select the [End] button in the bottom of the screen or press the [End] button on the keypad to automatically end a call.



## 1 Searching phonebook



- 1 Select the [Phonebook] button in the bottom right of the Today Screen, or select **Start** ► **Contacts**.

- 2 Enter a name in the [Enter a Name...] field to search for the phone number.

## 2 Registering entry

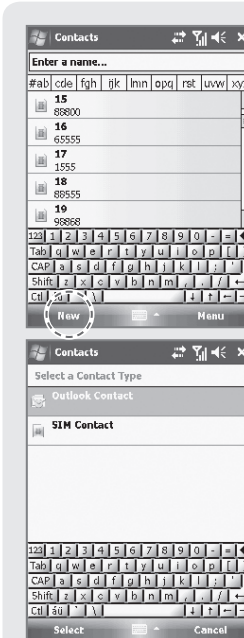

- 1 Select the [New] button in the bottom left of the Phonebook screen.

- 2 Select the type of phone number.

## Phonebook

### 2 Registering entry - 2



- ③ Enter all the fields, and select [ok] in the top right of the screen to register the entry in the phonebook.

### 3 Viewing menu

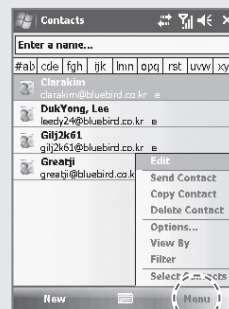

Select the [Menu] button in the bottom right of the Phonebook window.

**Edit** : You can edit the existing phone number.

**Send Contact** : You can send a phone number through wireless communication.

**Copy/Delete Contact** : You can copy/delete the selected phone number.

**Options...** : You can select <Show alphabetical index> or <Show contact names only>.

**View By** : You can set the display standard of phone number by name / Company.

**Filter** : You can set filters for display.

**Select Contacts** : You can select Several / All.

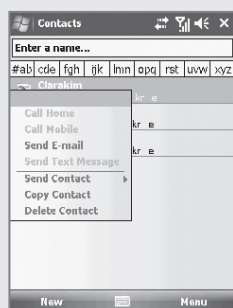

If you press and hold the selected phonebook entry, you can use various menus.

**Call Work/Home/Mobile** : A call is made to the registered number.

**Send E-mail** : An e-mail is sent to the registered e-mail address.

**Send Text Message** : An SMS message is sent to the registered number.

**Copy Contact** : You can copy the selected entry.

**Delete Contact** : You can delete the selected entry.

# Text Message

## 1 Creating a Text Message

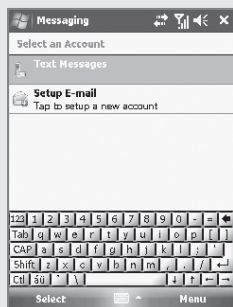

### Start ► Messaging ► Text Messages

or  
on the Today screen, tap Messages.

Go to Text Message screen, tap [Menu] and select [New] or Go to Phone screen, Select a contact name from Call History. Tap Menu and Select tap Contacts and select [Send Text Message]

Tap Inbox on Text Message screen.  
Inbox shows Deleted Items/ Drafts/Outbox/sent Items folders

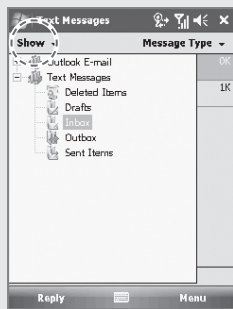

## 2 Sending a Text Message

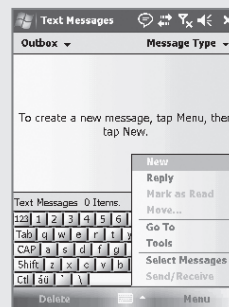

### Start ► Messaging ► Text Messages ► Outbox

After creating Text message including message receiver, tap Send on the Text Messages screen.

On the Text Messages screen, tap Menu and select [Add Recipient...] to add message receiver.

Maximum 18 people can be added to message receiver.

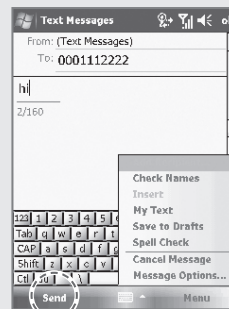

### 3 Viewing Text messages

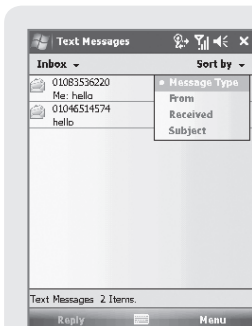

Checking a text message from 'Inbox' folder.

**Start ► Messaging ► Text Messages ► Inbox**

Choose receiving message from Inbox to view the text message.

Tap Received the text message at least 2 second to Reply/Delect/forward.

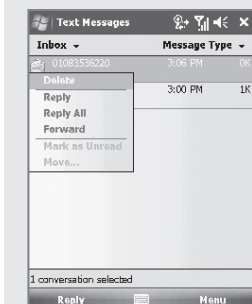

### 4 Managing Draft messages

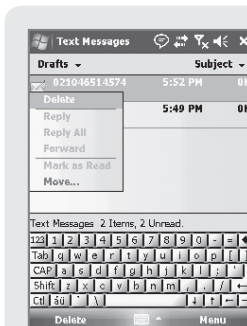

A creating message will be stored automatically in Draft folder if error is occurred in sending a message.

**Start ► Messaging ► Text Messages ► Drafts**

Tap the draft message at least 2 second to Reply/Delect/forward.

Tap the draft message to edit the message and resend. After sending a message, the message will be removed automatically from Drafts folder.

# Text Message

## 5 Managing Deleted Items

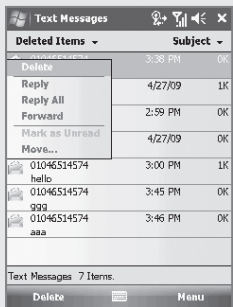

A deleted message will be stored automatically in Deleted Items folder.

Find the deleted message from **Start ► Messaging ► Text Messages ► Deleted Items**

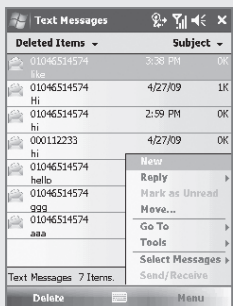

## 6 Managing Sent Messages

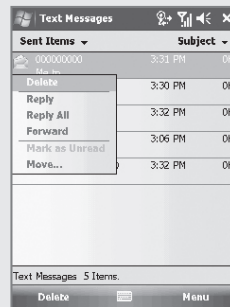

A sent message will be stored automatically in Sent Items folder.

Find the deleted message from **Start ► Messaging ► Text Messages ► Sent Items**

Tap the sent message at least 2 second to Reply/Delect/forward.

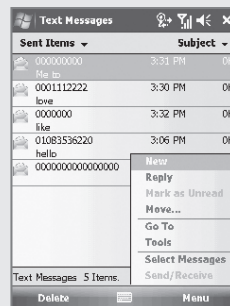

## 1 Taking photos

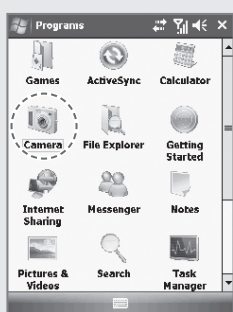

Start ► Programs ► Camera



If you press the [Barcode] button in the center of the terminal as Camera is enabled, the terminal takes an Still/Video.

Barcode button

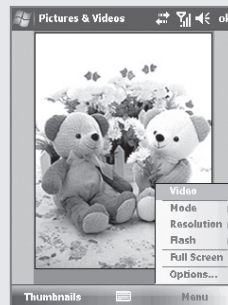

If you press the [Barcode] button, the terminal takes the Still/Video and automatically saves the Still/Video in the album.

Menu

**Video** : Switches into video recording.

**Mode** : You can select Normal/ Burst/Timer.

**Resolution** : 480×640/600×800/ 768×1024/1536×2048.

**Flash** : Select/deselect flash function.

**Full Screen** : The display is extended to the entire screen.

**Options...** : You can select Name/Folder/Size of files.

# Camera

## 1 Taking photos - 2

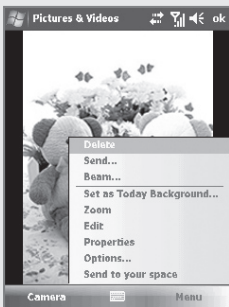

By selecting the [Menu] button, you can select Delete, Send, Beam, Set as Today Background, Zoom, Edit, Properties, Options, Send to your space for the Still/Video.

The terminal may get off or switch into the standby mode in case the battery is low.



**CAUTION**

If the camera is not used for 1 min, the terminal switches into the standby mode.

The video function may be different from this User's Manual according to the camera program.

## 2 Viewing album

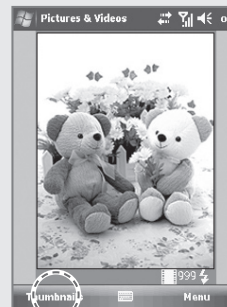

**Start ▶ Programs ▶ Camera ▶ Thumbnails**

You can extend/reduce the selected Still/Video, or check information on the Still/Video.

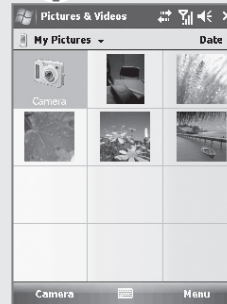



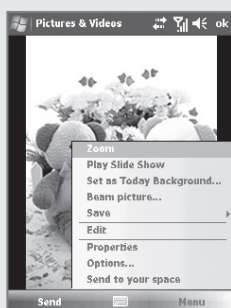

By selecting the [Menu] button, you can select Zoom, Play Slide Show, Set as Today Background, Beam picture, Save, Edit, Properties, Options or Send to your space for the selected Still/Video.



## Sounds & Notifications

### Sounds Tab

You can select whether to use notification tones for Events, Programs, Screen taps, Hardware buttons.

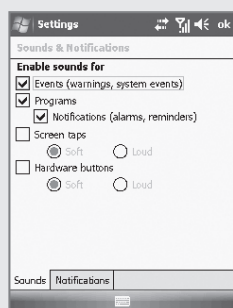

**Start ► Settings ► Personal Tab ► Sounds & Notifications**

As you select items, sounds and notifications are set for the items, and the terminal notifies you of status or event with sound.

### Notifications Tab

You can select the sound method and notification tone for status or event.

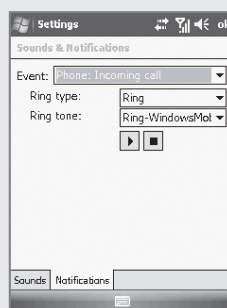

**Start ► Settings ► Personal Tab ► Sounds & Notifications ► Notifications Tab**

You can select Ring type and Ring tone for status or event, including phone, wireless network, alert and ActiveSync.

# Settings

## 1 Setting personal environment - 2



### Owner Information

You can set owner information or memo.



**Start ▶ Settings ▶ Personal Tab ▶ Owner Information**

You can register user Name, Company, Address, Telephone, E-mail and Notes, and select if they are to be displayed when the terminal is switched on.



### Today

#### Appearance Tab

You can select an image in the terminal as the background of Today screen.

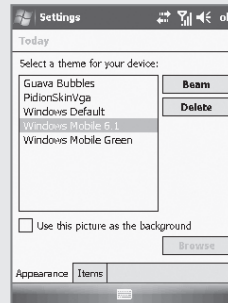

**Start ▶ Settings ▶ Personal Tab ▶ Today**

- ① Select [Use this picture as the background], and select the [Browse] button.
- ② Select the [Folder] in which the desired photo is stored.
- ③ Select the picture file [Type].
- ④ Select the picture file and press the [ok] button.

### Items Tab

You can select items to be displayed on the Today screen.

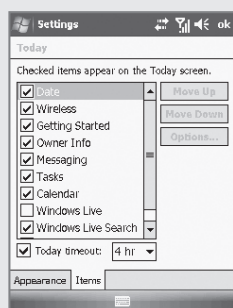

**Start ► Settings ► Personal Tab ► Today ► Items Tab**

The selected items on the list are displayed on Today screen. You can change the order of display of the items with the [Move Up]/[Move Down] button.

### Input

You can select the text input method or the voice recording format.

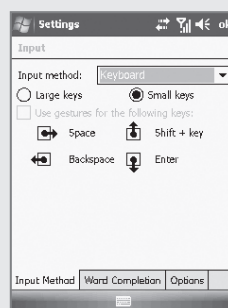

**Start ► Settings ► Personal Tab ► Input**

If you select Option for Handwriting, you can make setting for Handwriting layout for left hander / Three handwriting input boxes / Restriction of handwriting recognition time.

### Options Tab

You can select the voice recording format.

## Settings

### 1 Setting personal environment - 3

#### Lock

##### Password Tab

Use this function to protect data by setting the terminal to request password every time it is switched on.



##### Start ► Settings ► Personal Tab ► Lock

Enter the password in the Password field, and enter it again for confirmation.

Select [Prompt if device unused for], and enter time.

The password should be 4 ~ 8 digits, and repeated numbers (e.g., [1111]) or sequential numbers (e.g., [1234]) is not allowed.

If [Prompt if device unused for] is selected, if the terminal is left unused for the designated time, the following window pops up.

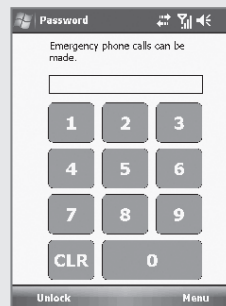

Enter the password, and select [Unlock] in the bottom of the screen.

### Hint Tab

Enter the words which will help you remembering your password.

A [Hint] window pops up if you fail to enter the correct password for 4 consecutive times.



### Phone

#### Phone Tab

You can select/deselect sound of the terminal.

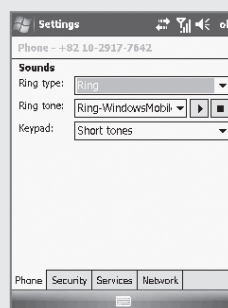

**Start ► Settings ► Personal Tab ► Phone ► Phone Tab**

**Ring type** : You can select Ring / Increasing ring / Ring once / Vibrate / Vibrate and ring / Vibrate then ring / None.

**Ring tone** : You can select a bell.

**Keypad** : You can set the keypad tone from Long tones / Short tones / Off.

# Settings

## 1 Setting personal environment - 4

### Phone - 2

#### Security Tab

You can set a password for USIM card to prevent unauthorized use when it is lost or stolen.

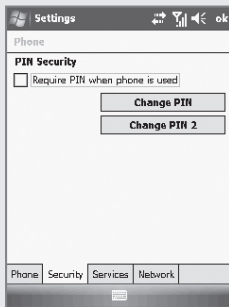

**Start ▶ Settings ▶ Personal Tab ▶ Phone ▶ Security Tab**

Select [Require PIN when phone is use], enter 4~8 digit password, and select [ok].

To change your password, select [Change PIN].

See p. 15 for details.

## 2 Setting system environment

### Memory

Current status of memory (In use, Free) is displayed.

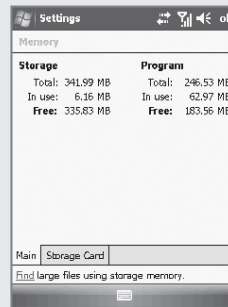

**Start ▶ Settings ▶ System Tab ▶ Memory**

#### Main Tab

You can find Total / In use / Free for memory storage and program.

#### Storage Card Tab

You can find the status (In use / Free) of the MicroSD memory and ProgramStore.



## External GPS

### Program Tab

Select the port to be used by the program to import the GPS data.

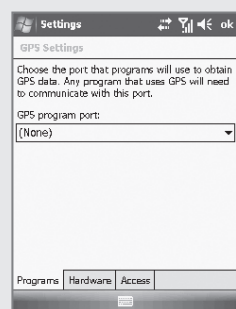

**Start ► Settings ► System Tab ► External GPS**

All the programs which use GPS can communicate through this port.

### Hardware Tab

Designate the hardware port with which the GPS device is to be connected.

### Access Tab

If you select [Manage GPS automatically], GPS data from multiple programs can be imported at the same time.

## Task Manager

The list of the programs in use and the memory status are displayed.

Application	Mem	CPU
Internet Explorer	2.83M	0 %
ActiveSync	1.09M	0 %
Pictures & Videos	676K	0 %
Messaging	620K	0 %
Tasks	476K	0 %
Contacts	476K	0 %
Help	336K	0 %
File Explorer	136K	0 %
Notes	132K	0 %
Wireless Manager	96.0K	0 %
Task Manager	92.0K	21 %

**Start ► Settings ► System Tab ► Task Manager**

With the menu, you can exit all or specific programs.

# Settings

## 2 Setting system environment - 2

### Backlight

#### Battery Power Tab / External Power Tab

You can set the LED Off time after which the LED should be turned off automatically if no key action has been made.

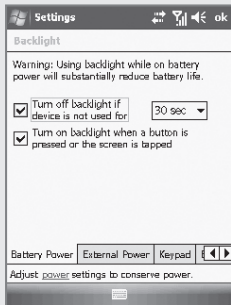

**Start ▶ Settings ▶ System Tab ▶ Lighting ▶ Battery Power Tab / External Power Tab**

The shorter the LED Off time, the battery life extends longer.

The LED is turned on when you press any button or touch the screen.

#### Keypad Tab

Set the keypad LED Off time.

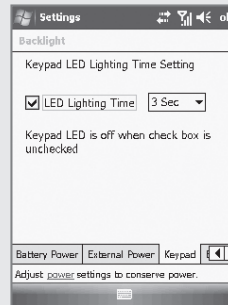

**Start ▶ Settings ▶ System Tab ▶ Lighting ▶ Keypad Tab**

The shorter the [LED Lighting Time], the battery life extends longer.

The keypad remains off if no [LED Lighting Time] is selected.

## Brightness Tab

You can control brightness by moving the slider bar.

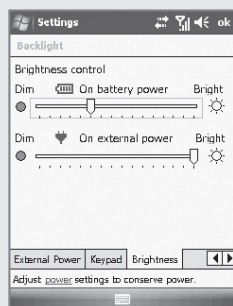

**Start ► Settings ► System Tab  
► Lighting ► Brightness Tab**

The nearer to [Dim], the longer the battery life extends.



## Remove Programs

The list of programs installed personally or by the company, except the basic programs, is displayed.

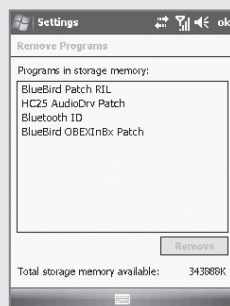

**Start ► Settings ► System Tab  
► Remove Programs**

Select the program you wish to uninstall, and then, select the [Remove] button.

## Settings

### 2 Setting system environment - 3

#### Screen

##### General Tab

Switch the screen to Portrait / Landscape (right-handed) / Landscape (left-handed).

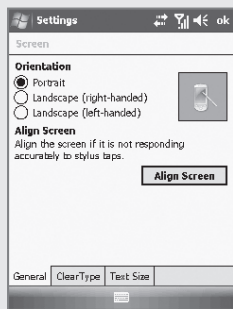

**Start ▶ Settings ▶ System Tab ▶ Screen**

If you select the [Align Screen] button, you can reset the stylus pen points. See p.20 for details.

##### Text Size Tab

The text size displayed on the screen can be set by 5 steps.

### 3 Setting connection environment

#### Bluetooth

##### Devices Tab

Set the Bluetooth Device (Bluetooth printer, card reader, etc.) for communication with the terminal.



**Start ▶ Settings ▶ Connections Tab ▶ Bluetooth**

- ① Search Bluetooth device at near to select [Add New Hardware].
- ② Choose the Bluetooth device to connect and select [Next].
- ③ Select [Finish] after confirming the chosen device name.



CAUTION

Starting of Bluetooth device is depending on the Bluetooth device model. Please refer to the manual of the Bluetooth device.

### Mode Tab

You can set communication with the Bluetooth device.



**Start ► Settings ►  
Connections Tab ► Bluetooth  
► Mode Tab**

#### Turn on Bluetooth :

Select whether to use the Bluetooth device. To extend the battery life, you should uncheck this option.

**Make this device visible to other devices :** This option allows BIP-6000 to be searched by other devices.

### COM Ports Tab

Select the COM port to be connected with the Bluetooth device.

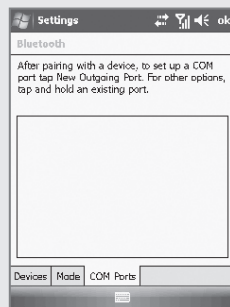

**Start ► Settings ►  
Connections Tab ► Bluetooth  
► COM Ports Tab**

## Settings

### 3 Setting connection environment - 2

#### USB to PC

You can set the communication environment with PC.



**Start ▶ Settings ▶ Connections Tab ▶ USB to PC**

Computers adopting the tunneling VPN can make a connection with the terminal through RNDIS. In this case, uncheck [Enable advanced network functionality] before attempting to connect.

If [ActiveSync] is not started when the terminal is connected with PC normally, you should select [Enable advanced network functionality].

#### Wi-Fi

You can set the Wi-Fi wireless Internet.

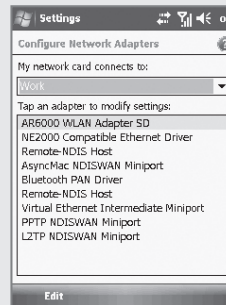

**Start ▶ Settings ▶ Connections Tab ▶ Wi-Fi**

You can set the Wi-Fi environment for access with AP (Access Points) through wireless Internet.

## Wireless Manager

### Setting wireless Internet

- ① Select Wi-Fi on the Wireless Manager window. Then the list of nearby APs is displayed.
- ② Select an AP on the wireless networks list, and select the [Connect] button.

### If APs list is not displayed, set the connection manually.

- ① On the Wireless Network Configuration window, select [Add].
- ② Enter the AP name on the [Network Name] field, and select [Next].
- ③ After selecting [Next], check [Provide key automatically], and select [Next].
- ④ Select [Finish], and the selected AP is displayed in the wireless networks list.
- ⑤ Select the [Connect] button to connect the wireless LAN.

### Start ► Settings ► Connections Tab ► Wireless Manager

You can select [All] to enable/disable three functions at the same time, or select [Wi-Fi] / [Bluetooth] / [Phone] for independent enabling/disabling.



## Settings

### 3 Setting connection environment - 3

#### Wireless Manager - 2

When you enable this function, you can set the details of this function.

When you disable this function, you can set the function independently by selecting the [Menu] button in the bottom right of the screen.



**Q The terminal is wet. What can I do?**

**A** Detach the battery from the terminal and dry it. If the terminal still doesn't work after it is dried for a certain period of time, it is required to replace the main board and other parts.

**Q The terminal fails to boot.**

**A** The program might have been damaged. Reset the terminal, and if the problem continues, contact the Customer Care Center.

**Q The battery is not charged.**

**A** Make sure that the terminal is properly connected with the desktop charger, and check if the lamp works properly. Rub off the charging terminal clean. If it is not charged normally, it can be because of aging or failure of the battery. (Warranty period for a battery is 6 months.)

**Q How can I ask for after-sales service?**

**A** Please send the product to the Customer Care Center in the head office through a pre-paid delivery service. Upon repairing the product, we will send you the product through a pre-paid delivery service.

**Q Can I check if the terminal is sent accurately?**

**A** You can get the invoice number from the Customer Care Center in the head office. Contact the delivery service to find out the current location of the terminal.

**Q The battery goes dead too soon.**

**A** Peripherals such as barcode reader and printer will consume a large amount of battery power. If this phenomenon continues, it may be because of aging of the battery. You should use a new battery.

- ※ If the product does not work normally despite the measures taken as mentioned above, please contact the nearest Customer Care Center.
- ※ Repairing fee will be charged for the product of which warranty period (1 year from the date of purchasing) is expired.

## Customer Service

### Before Requesting After-Sales Service

- Before asking for after-sales service, please back up the data from the terminal.
- We do not back up data from the products received in the Customer Care Center. Therefore, we assume no responsibility for loss/deletion of data.

### Bluebird Soft Customer Service

- FAX : +82-2-548-0870
- E-Mail : [gcs@bluebird.co.kr](mailto:gcs@bluebird.co.kr)
- Address : **Customers Service Center, 2nd floor, 558-8, Shinsa-dong, Gangnam-gu, Seoul, Korea**

### Operating hours

- Mon.-Fri. : 9 A.M. ~ 6 P.M. (GMT Time: +9 Hours)
- The center is closed on Saturdays, Sundays and holidays.

### Registering for After-Sales Service

- We receive the products for after-sales service through mail, delivery service and hand carry only in principle.
- If you bought the product from any party other than the authorized dealer, you need to register the product before asking for after-sales service.
- Please enclose an evidence of purchasing or the receipt to the product for after-sales service.
- Please enclose the name, telephone number, address and symptom for prompt service.
- You can ask for after-sales service through the dealer or the Customer Care Center in the head office.
- Do not intentionally damage the label on the product.
- Damaged label may result in a disadvantage to the customer.
- When you return the product to Bluebird Soft for service, please put the product in a protective box.
- No warranty will not be provided for any damage occurring during delivery. We recommend you to use the box and protective cover supplied with the product.
- Make sure to deliver the product in a safe way. Bluebird Soft assumes no responsibility for loss of the product during delivery.

## Service Center Information

BIP-6000

### Regulations on Free/Charging Repairs

Type of Customer Damage		Contents of Compensation	
		Within the Term of Guarantee	After term of guarantee
When requesting important repairs within 10 days of purchase		Exchange or Repayment	
Requesting important repairs within 1 month since purchase date		Exchange or Repair Free of Charge	
An important repair is needed after 1 month of exchange		Exchange or Repair Free of Charge	
When it is impossible to exchange within 1 month		Repayment	
Possible Repairs	The same problem occurs 3 times	Repair Free of Charge	Charged Repair
	The same problem occurs 4 times	Exchange or Repayment	Charged Repair
	5 problems in all different parts		
Impossible Repairs	When the manufacturer has lost the product in which the customer has requested for a repair	Exchange or Repayment	Exchange after depreciation of the fixed price.
	When it is impossible to repair within 1 month		
	Impossible to exchange	Repayment	Exchange after adding 10% to the depreciated price of the fix price (the highest price-purchased price).

- The after-sales service will be provided according to the regulations for compensation for customers. The parts of the product will be retained for 3 years.
- Replacement will be made with the same model in principle. If the same model is not available, a similar model will be provided as a replacement. The customer may select refund if he/she does not want replacement with a similar model.
- Refund will be made based on the price on the receipt.
- If the price on the receipt is higher than the normal price, it is considered to include incidental expenses. In this case, refund will be made based on the normal price.

## Service Center Information

### Charged Service

1. If it is not a default, it will be charged when requesting for after-sales service.
  - Service request due to inappropriate use of the customer
  - Loss of a PIN number
  - Use of programs that might effect the program (over-clock, forceful changes in the input of the system, personal developments)
2. Default due to a mistake on the part of the customer
  - Default due to inappropriate or careless use of the product (dropping, submersion under water, shock, damage, unreasonable operations, etc).
  - Default due to a repair or unauthorized technician.
  - Default caused intentionally or by carelessness of the customer.
  - Default due to the use of fraudulent parts or components.
3. Other cases
  - Default due to nature (fire, damage due to sea wind, flood damage, etc.).
  - Expendable parts have exhausted there life (batteries, antenna, or other component parts).
4. Regulations of treatment after charged service
  - If the same default occurs on the part that had been repaired within a 2 months(60 days) period, it will be provided with free of charge repair service.

### There will be no returning of goods or repayment upon the following situation

- Removal of the sealing of the product if it had been sealed.
- If the product has been damaged due to careless use by the customer or due to a natural disaster (floods, rain, fire, etc.).
- Loss of product or other components (CD, diskette, manual, connecting cables, etc).
- Damage to the product after 10 days of purchase, the product will either be exchanged or provided with after-sales service (note, returning of goods or repayment is not allowed).

## Warranty Certificate

BIP-6000

Thank you for purchasing a product from Bluebird Soft Inc.

- If a circumstance arises where you lose a receipt or the certificate of guarantee, then the term of guarantee will be calculated 3 months (certified by the number of the manufacture, a certificate of inspection) after the date of manufacture.
- In case of accessories (such as batteries), only those that match the sales list managed by the service center will be eligible for customer service.
- A repair or an exchange of batteries that does not match the sales list of the service center due to the carelessness of the customer will be fully charged.

Name of Product	PDA
Name of Model	BIP-6000
Date of Purchase	
Manufacture Number	
Place of Purchase	
Term of Guarantee	1 year from purchase

### Warranty

1. Bluebird Soft Inc. (hereinafter referred to as Bluebird) provides the warranty service for its products in compliance with the regulations on compensation for damage of customer.
2. Upon receiving a notification on a defect of its product within the range of warranty during the warranty period, Bluebird will repair or replace the defective product according to its warranty policy.
3. If the defective product within the range of warranty is not repairable or replaceable, Bluebird shall refund the purchasing price within a designated period from the date of receiving a notice of defect.
4. Bluebird assumes no responsibility for repairing, replacement or refund until it receives the defective product from the customer. The replacement shall be equivalent to a new product in the aspect of performance.
5. Warranty of Bluebird is valid in the countries where the Bluebird products are distributed by Bluebird. (Contract for additional warranty service like field service)
6. Bluebird products may contain the recycled products, components or materials equivalent to new products in the aspect of performance.
7. This warranty is applied to software products only when the programming commands are not executed. Bluebird does not guarantee interruption-free or error-free performance.



### Customers Service Center

#### Hours

Mon.- Fri. : 9 A.M. ~ 6 P.M.  
(GMT Time: +9 Hours)

We are not open on Saturday,  
Sundays and National Holidays.

Address : Customers Service Center  
2nd Floor, 558-8, Sinsa-dong,  
Gangnam-gu, Seoul, Korea

Bluebird constantly strives to bring utmost satisfaction to all our customers.