



Newland

SCANNING MADE SIMPLE



MT90 Orca mobile computer user guide

Disclaimer

© 2018 Fujian Newland Auto-ID Tech. Co., Ltd. All rights reserved.

Please read through the manual carefully before using the product and operate it according to the manual. It is advised that you should keep this manual for future reference.

Do not disassemble the device or remove the seal label from the device, doing so will void the product warranty provided by Fujian Newland Auto-ID Tech. Co., Ltd.

All pictures in this manual are for reference only and actual product may differ. Regarding to the product modification and update, Fujian Newland Auto-ID Tech. Co., Ltd. reserves the right to make changes to any software or hardware to improve reliability, function, or design at any time without notice. The information contained herein is subject to change without prior notice.

The products depicted in this manual may include software copyrighted by Fujian Newland Auto-ID Tech. Co., Ltd or third party. The user, corporation or individual, shall not duplicate, in whole or in part, distribute, modify, decompile, disassemble, decode, reverse engineer, rent, transfer or sublicense such software without prior written consent from the copyright holders.

This manual is copyrighted. No part of this publication may be reproduced, distributed or used in any form without written permission from Newland.

Risk Warning Regarding Unauthorized System Updates:

You should use the Newland-provided tool to update this product's system. Modifying system files through installing a third-party ROM system or using any cracking method may result in product malfunction or data loss and this will void your warranty.

Fujian Newland Auto-ID Tech. Co., Ltd. reserves the right to make final interpretation of the statement above.

Fujian Newland Auto-ID Tech. Co., Ltd.

3F, Building A, No.1, Rujiang West Rd., Mawei, Fuzhou, Fujian, China 350015

<http://www.newlandaidc.com>

Revision History

Version	Description	Date
V1.0.0	Initial release.	January 16, 2018
V2.0.0	<ol style="list-style-type: none">1. Updated all the screenshots.2. Modified the “Accessories (Optional)”, “Charging the Battery” and “Communicating with PC” sections, and deleted the “Cradle” section in Chapter 2.3. Added the “Floating Button Settings”, “Clearing the App Cache” and “Power Saving Settings” features, and modified the “Status Icons” section in Chapter 3.4. Added the “Data Edit”, “Central Area Decoding”, “Noise Reduction”, “Exposure Level” and “Power Plan” features, and deleted the “Data Extraction” and “Character Replacement” features in Chapter 4. <p>Note: User Guide V2.0.0 or later is only applicable to MT90 (Android 7.0).</p>	May 18, 2018

Table of Contents

Revision History	- 3 -
Chapter 1 About This Guide	1
Introduction.....	1
Documentation Set.....	1
Chapter Descriptions.....	1
More Information	2
Chapter 2 Getting Started	3
Introduction.....	3
Unpacking	3
Accessories (Optional)	3
Getting Started	4
The MT90.....	4
Keypad.....	6
LEDs on the MT90	7
Installing the Battery	8
Removing the Battery	8
Charging the Battery	9
Communicating with PC.....	10
Installing the Micro SD Card/SIM Card	11
Chapter 3 Basics	12
Introduction.....	12
Switching On/ Rebooting/ Switching Off the MT90	12
Locking/Unlocking the MT90	12
Home Screen	13
Status Icons.....	14
Installing App	15
Uninstalling App.....	15
Date & Time.....	16
Display.....	16
Ringtones	17

Restoring Factory Settings	17
Floating Button Settings	18
Clearing the App Cache.....	19
Power Saving Settings	19
Shortcuts to Apps	20
Widgets	20
Chapter 4 Scanning Barcodes	21
Introduction.....	21
Scanning 1D Barcode	21
Scanning 2D Barcode	22
Programming Scanner.....	23
Enable Scan.....	23
Output Mode	24
Scan Mode.....	25
Scan Trigger.....	25
Prefix & Suffix	26
Good Read Indicator.....	26
Encoding	27
Data Edit	28
Symbologies	28
Chapter 5 Bluetooth	30
Chapter 6 Wi-Fi	31
Introduction.....	31
Wi-Fi Settings.....	31
IP Settings	32
Chapter 7 Mobile Network	33
Introduction.....	33
Mobile Network Settings.....	33
APN Settings	34
Chapter 8 Admin Tool.....	35
Introduction.....	35

Setting the Admin Password.....	35
Setting the Admin Mode	36
Entering/Exiting the User Mode	37
Chapter 9 Whitelist Manager	38
Introduction.....	38
Logging in Whitelist Manager	38
Chapter 10 Others	40
Camera.....	40
GPS.....	41
NFC (optional).....	42
Memory Cleanup	43
Chapter 11 System Update	44
Chapter 12 App Development Guide.....	45
Development Environment	45
Use of Non-standard Interfaces.....	45
Chapter 13 Maintenance & Troubleshooting.....	46
Introduction.....	46
Important Safety & Handling Information.....	46
Disassembly and Retrofit	46
External Power Supply.....	46
Abnormal Situation.....	46
Drop Damage.....	46
LCD Screen	46
Stacking Heavy Objects.....	46
Mounting Location.....	47
Wireless Functionalities	47
Use & Maintenance.....	47
Battery Safety Guidelines.....	47
Troubleshooting.....	48

Chapter 1 About This Guide

Introduction

This guide provides instructions for programming and operating the NLS-MT90 portable data collector (hereinafter referred to as “**the MT90**” or “**the terminal**”).

Documentation Set

The documentation set for the MT90 includes:

- ✧ ***NLS-MT90 Portable Data Collector Quick Start:*** Describes how to get the NLS-MT90 up and running.
- ✧ ***NLS-MT90 Portable Data Collector User Guide:*** Describes how to program and use the NLS-MT90.

Chapter Descriptions

- ✧ *Chapter 1 About This Guide* Provides general description of this manual.
- ✧ *Chapter 2 Getting Started* Provides information on getting the MT90 up and running for the first time.
- ✧ *Chapter 3 Basics* Describes how to program the MT90 for the use of its basic features.
- ✧ *Chapter 4 Scanning Barcodes* Provides the instructions as to how to scan 1D/2D barcodes and how to program the scanner.
- ✧ *Chapter 5 Bluetooth* Explains how to use Bluetooth functionality.
- ✧ *Chapter 6 Wi-Fi* Explains how to use Wi-Fi functionality.
- ✧ *Chapter 7 Mobile Network* Explains how to use Mobile Network functionality.
- ✧ *Chapter 8 Admin Tool* Explains how to use the admin tool.
- ✧ *Chapter 9 Whitelist Manager* Explains how to use the whitelist management tool.
- ✧ *Chapter 10 Others* Explains how to use Camera, GPS and NFC functionalities.
- ✧ *Chapter 11 System Update* Explains how to update the system.
- ✧ *Chapter 12 App Development Guide* Describes the app development environment and the use of non-standard interfaces.
- ✧ *Chapter 13 Maintenance & Troubleshooting* Provides troubleshooting solutions for issues that might occur when using the MT90.

More Information

For more product and support information, please visit our web site: <http://www.newlandaidc.com>.

Chapter 2 Getting Started

Introduction

This chapter lists the parts and accessories for the MT90 and explains how to install, remove and charge the battery, and power on the MT90 for the first time.

Unpacking

Carefully remove all protective material from the pack and verify that the following items are present:

- ✧ 1 x NLS-MT90 main unit
- ✧ 1 x USB cable
- ✧ 1 x AC adapter for the MT90
- ✧ 1 x Li-Polymer battery
- ✧ 1 x Hand strap
- ✧ 1 x Quick Start manual

Accessories (Optional)

- ✧ Rubber boot
- ✧ Ethernet charging cradle
- ✧ USB charging cradle
- ✧ Pistol grip

Getting Started

The MT90

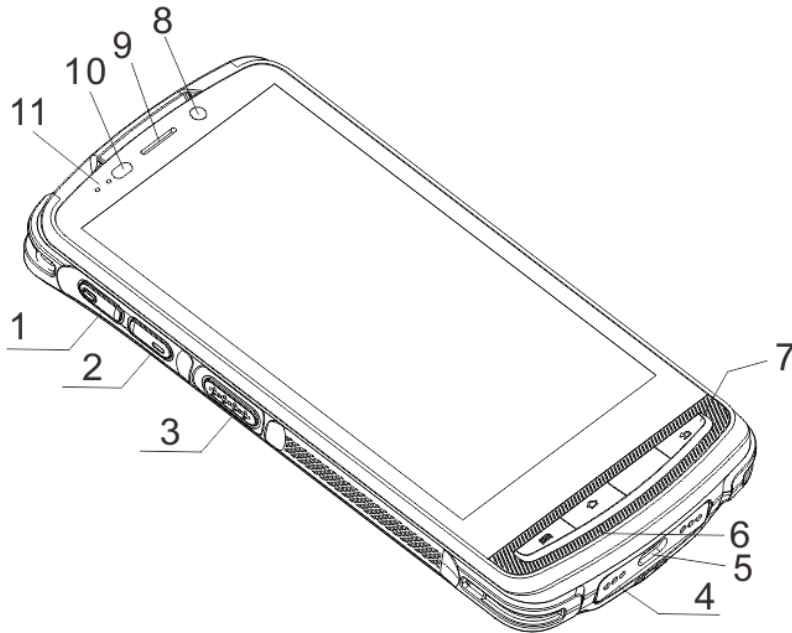

1	Volume+	2	Volume-
3	Left Scan Key	4	Cradle Connector
5	Micro USB Port	6	Microphone
7	Keypad	8	Front Camera (optional)
9	Earpiece	10	Light/Proximity Sensors
11	Red/Blue LEDs		

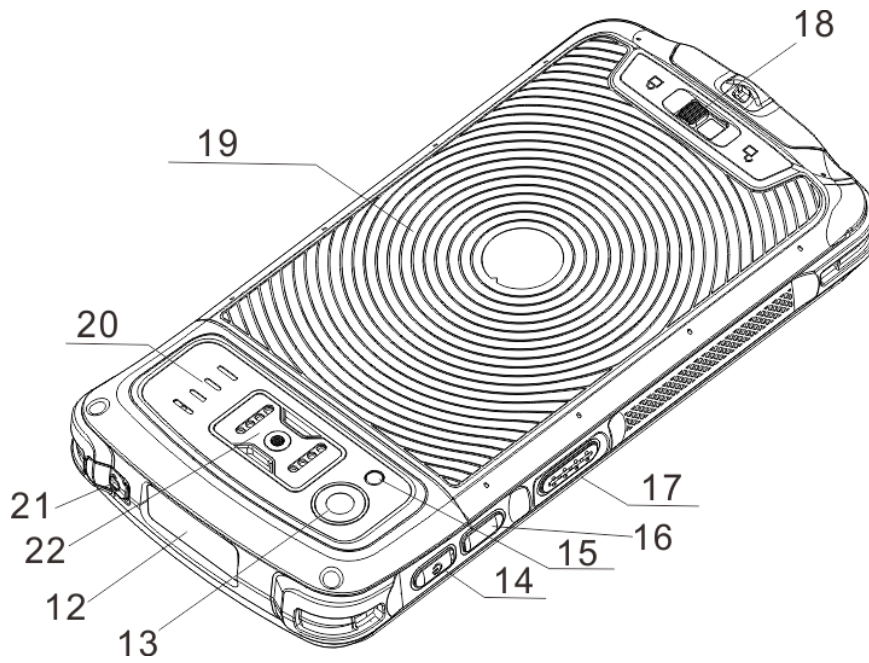

12	Scan Window	13	Flashlight
14	Power Key	15	Rear Camera
16	User-defined Key	17	Right Scan Key
18	Battery Cover Latch	19	NFC Detection Area
20	Speaker	21	Headphone Jack Cover
22	Expansion Port		

Keypad

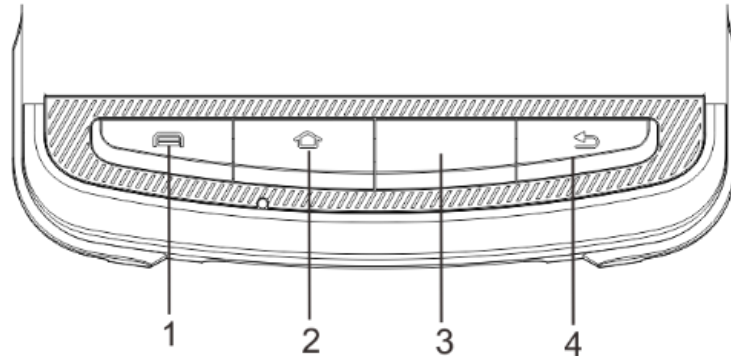

1 Menu Key

2 Home Key

3 Scan Key

4 Return Key

The MT90 has 10 keys, with Menu/Home/Scan/Return keys on the front panel, Volume+/Volume-/Scan keys on the left side and Power/User-defined/Scan key on the right side.

Menu Key: Press it to display the menu related to an on-screen item.

Home Key: Press it to go to the first Main Screen.

Press and hold the key to display the app(s) most recently used. Tap an app to open it.

Function Key: Use it to scan barcodes.

Return Key: Press it to go back to the previous screen.

Except the Power key, other keys are user programmable.

LEDs on the MT90

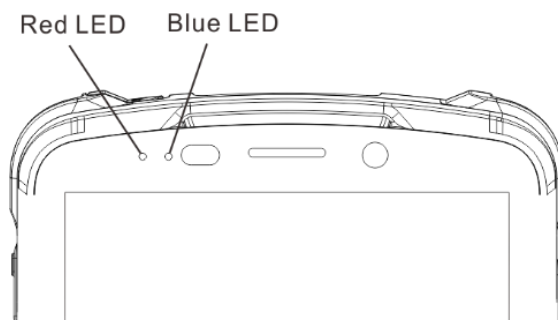

Scan/Decode	
Blue LED flashes once	Good read
Charging/Battery Statuses	
Blue LED on	Fully charged
Red LED on	Charging in progress
Red LED flashes constantly	Low-battery alert

Installing the Battery

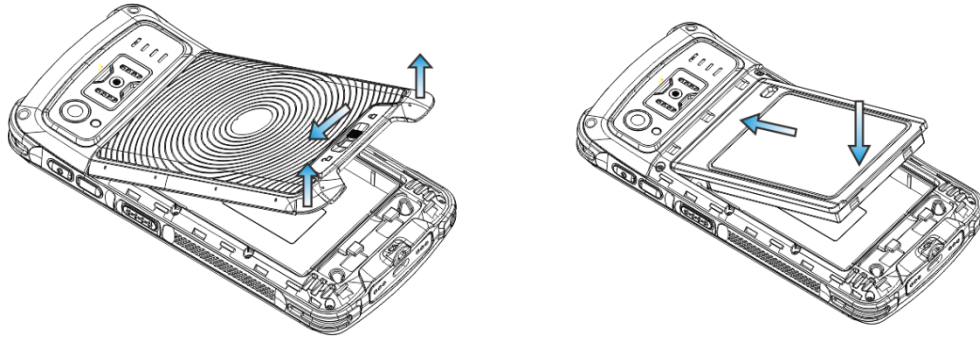

Step 1: Slide the battery cover latch to the unlock position and remove the cover.

Step 2: Insert the battery as indicated into the battery compartment, with its metal contacts facing down and lining up with the metal contacts on the inside of the terminal.

Removing the Battery

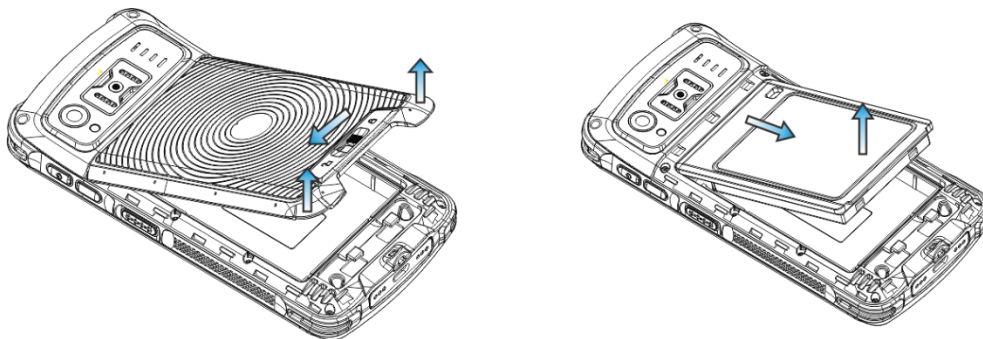

Step 1: Hold down the Power key for 5 seconds and then tap "Power off" to turn off the terminal. Slide the battery cover latch to the unlock position and remove the cover.

Step 2: Remove the battery.

Charging the Battery

Connect the MT90 to a power outlet using the included AC adapter. When the terminal's battery is less than 5%, it takes about 5 hours to fully charge it (The terminal is shut down or in sleep mode).

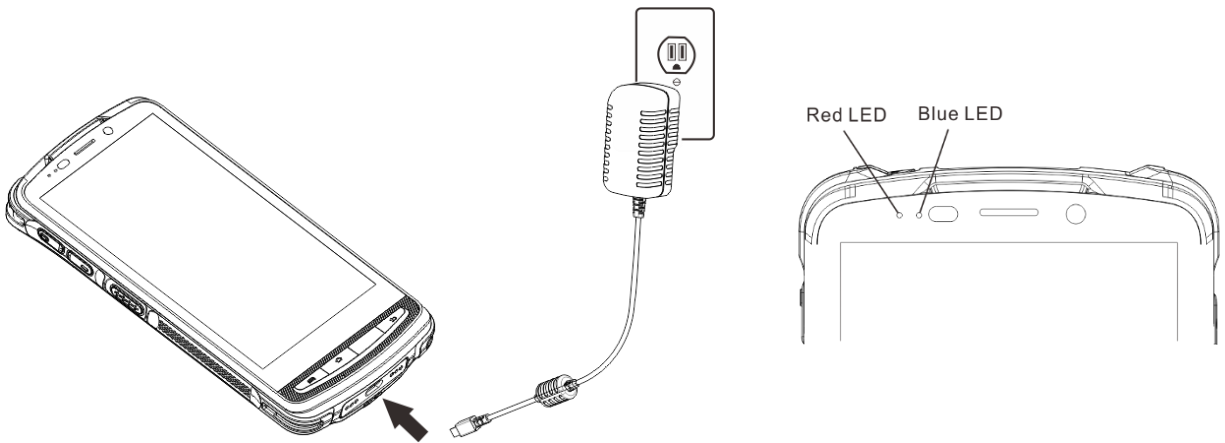

LEDs on the MT90	
Blue LED on	Fully charged
Red LED on	Charging in progress
Red LED flashes constantly	Low-battery alert

Note: Low battery may result in malfunction of the terminal. Before your first use, charge the battery for at least 6 hours.

Communicating with PC

Step 1: Connect the Micro USB port on the MT90 to your computer with the included USB cable.

Step 2: Switch the MT90 on. On the Home screen, swipe from top to bottom with one finger in one smooth motion to open the notification bar as shown below.

Step 3: Tap “USB for file transfer”.

Step 4: Select “Transfer files”. Navigate to the “My Computer” section of your computer and look for the newly added drive. Double-click it and you will be connected to the MT90. Then you may handle the files on the terminal through your computer.

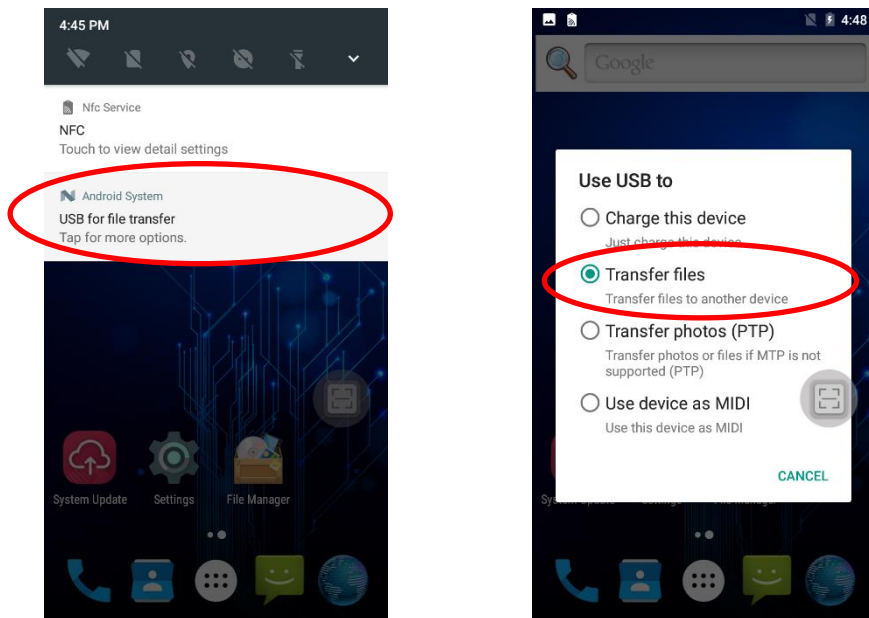

Installing the Micro SD Card/SIM Card

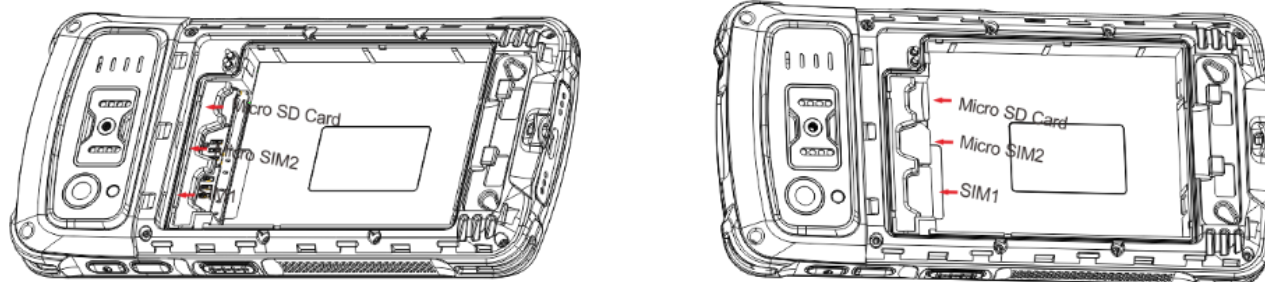

Step 1: Slide the battery cover latch to the unlock position and remove the cover.

Step 2: Insert the Micro SD card/ SIM card/ Micro SIM card into the corresponding slot, with its metal contacts facing down.

Chapter 3 Basics

Introduction

This chapter provides the basics of setting and using the MT90.

Switching On/ Rebooting/ Switching Off the MT90

After installing the SIM card and battery and having the MT90 fully charged, you may switch the terminal on.

Switch the MT90 on: Hold down the Power key on the right side of the terminal until the terminal vibrates. Note that the initialization is going to take some time before the MT90 displays the Home screen.

Reboot the MT90: Hold down the Power key on the right side of the terminal until the window below pops up, then tap “reboot”.

Switch the MT90 off: Hold down the Power key on the right side of the terminal until the window below pops up, then tap “Power off”.

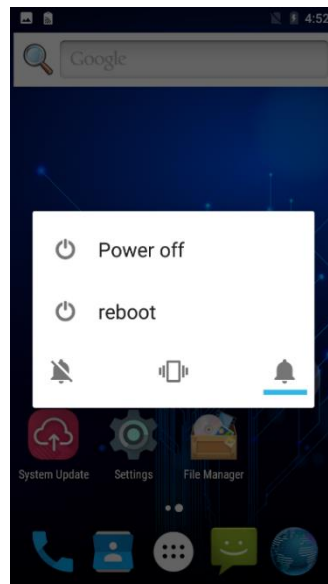

Locking/Unlocking the MT90

Lock the MT90: Briefly press the Power key on the right side of the terminal. If no operation is performed on the MT90 for a preset period of time, the MT90 locks automatically. You can change how long it takes for the MT90 to lock.

Unlock the MT90: Briefly press the Power key on the right side of the terminal.

Home Screen

View another Home screen: Swipe left or right.

Go to the Home screen: Press the Home key on the front panel of the terminal.

Open an app: Tap it.

View all apps/Open apps list: Tap .

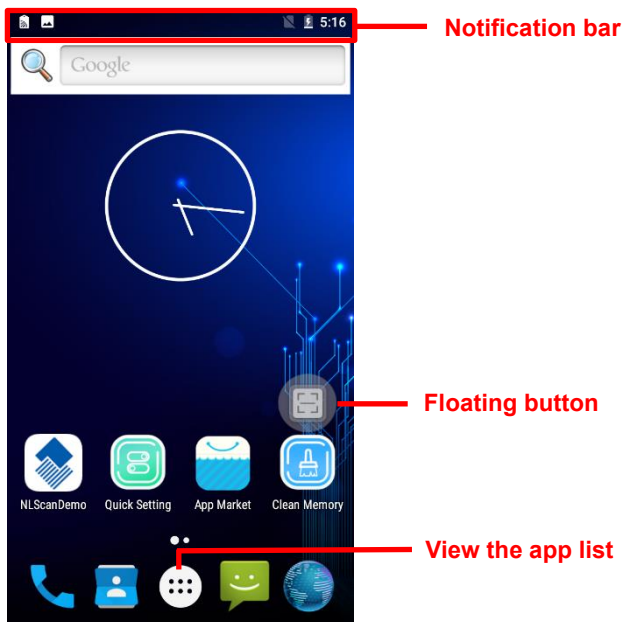













Add an app icon to the Home screen: Tap  on the Home screen. Tap and hold your desired app until it appears on the Home screen and then drag it into a blank area.

Delete an app icon on the Home screen: Tap and hold your desired app on the Home screen until “X Remove” appears, then drag the app into it. Note that this operation only removes the icon from the Home screen. To remove the app from the MT90, see the **Uninstalling App** section.

Status Icons

The icons in the notification bar at the top of the screen give information about the MT90.

Status Icon	Description	Status Icon	Description
	WLAN on		Signal strength
	Bluetooth on		Airplane mode on
	USB debugging		Missed calls
	Battery charging in progress		New messages
	Battery fully charged		Location off
	Vibrate on		NFC on
	Do Not Disturb mode off		

Installing App

Use one of the following methods to install a new app on the MT90:

1. Download an APK file from online app store and install it.
2. Download software package onto a Micro SD card or PC and copy it to your terminal. Then install it with File Manager.
3. Install a new app using a mobile assistant (such as Baidu Mobile Assistant) installed on the PC.

Uninstalling App

Follow the procedure below to remove an app from the MT90:

Tap  on the Home screen to view all apps. Tap and hold your desired app until a trash bin appears at the top right corner of the screen, then drag the app into the trash bin.

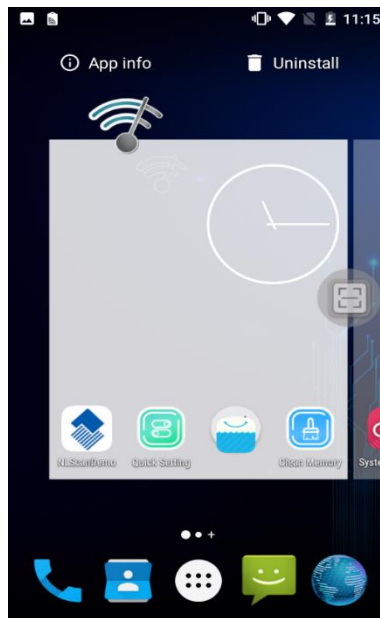

Date & Time

Set the date and time: Tap the app icon  and then “Date & time”, and set the date and time on the screen shown below as per your needs.

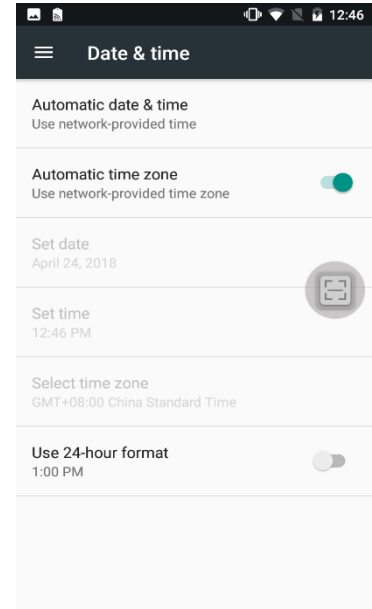
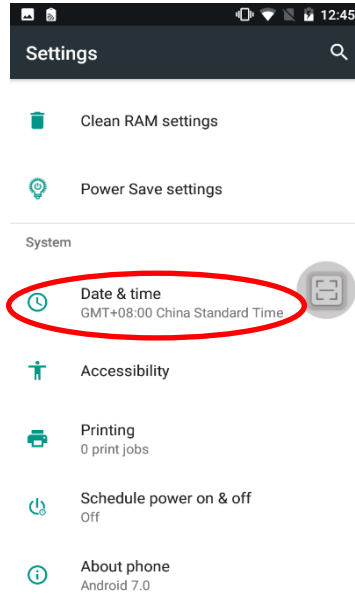

Display

Tap the app icon  and then “Display”, and set the brightness, wallpaper, sleep timer, font size and other parameters on the screen shown below as per your needs.

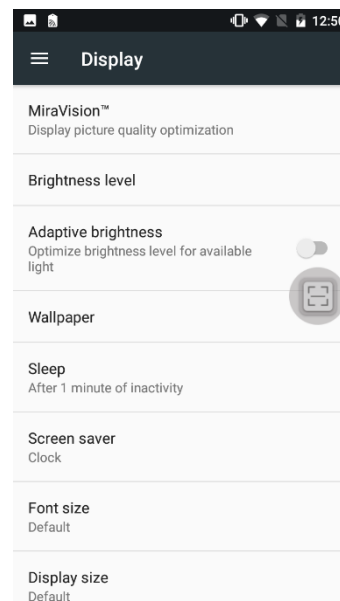
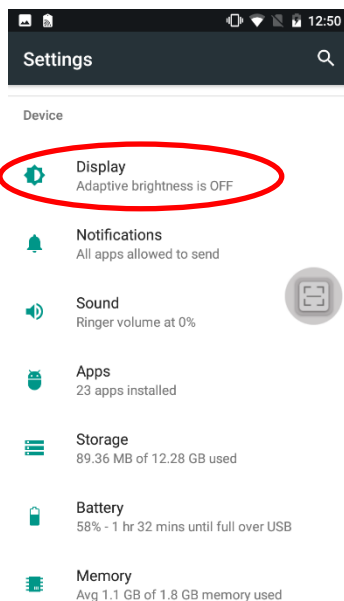

Ringtones

Tap the app icon  -> "Sound". Then set the ringtones and other notification sounds as per your needs.

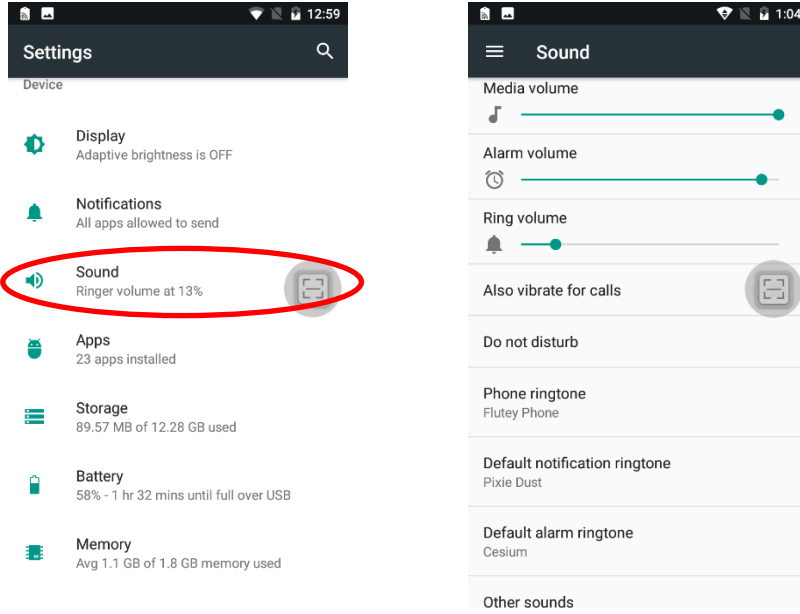

Restoring Factory Settings

Tap the app icon  -> "Backup & reset" -> "Factory data reset" -> "RESET PHONE" -> "ERASE EVERYTHING".

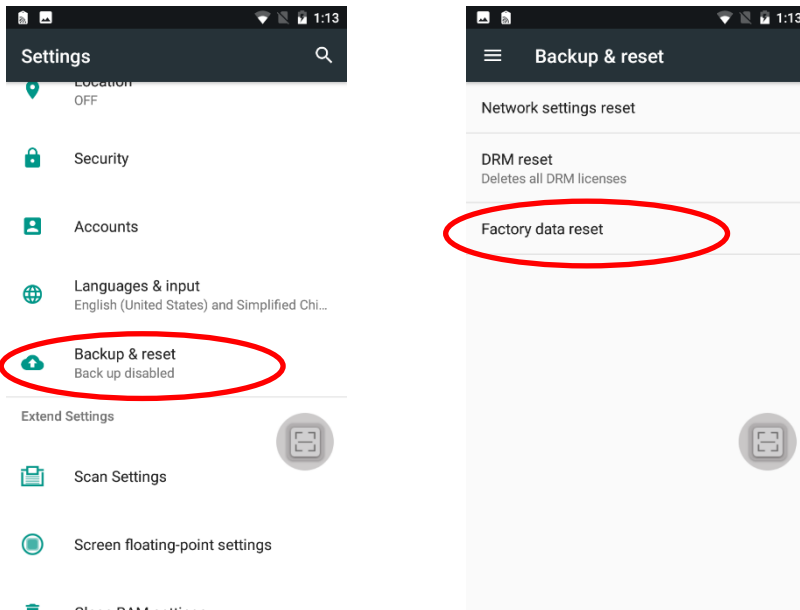

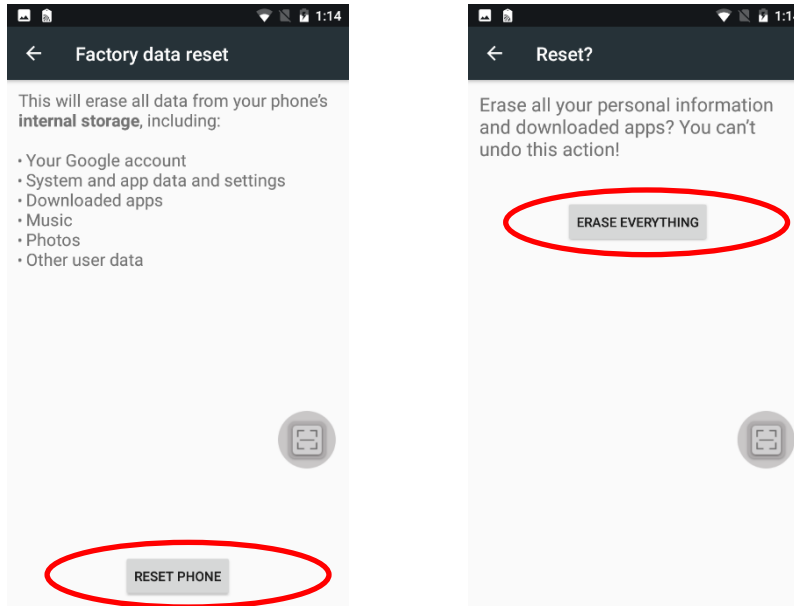

After this operation, the terminal will be reset to factory defaults and all the personal data on the internal storage, such as music and photos, will be deleted.

Floating Button Settings

Tapping the floating button can perform tasks such as scanning barcode (**Scan**), turning on/off flashlight (**Flashlight**), taking a screenshot (**Screen snapshot**), turning off screen (**Screen off**), or going to the Home screen (**Home**).

Show/Hide the floating button: Tap the app icon  -> "Screen floating-point settings" -> select/unselect "Show float box".

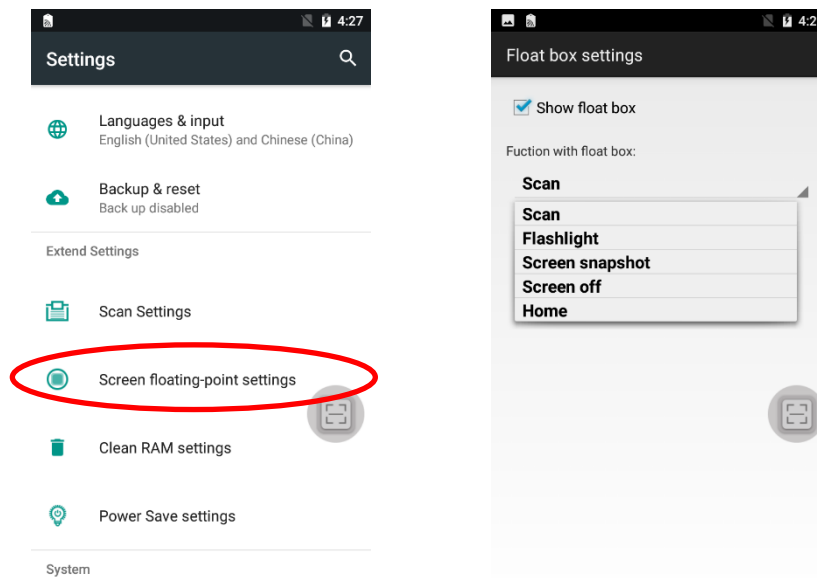

Clearing the App Cache

Tap the app icon  then “Clean RAM settings”, tap the ON/OFF slider to ON, and then select the app(s) whose cache you **DO NOT** want to clear. The unselected apps’ cached data will get cleared when the terminal enters the sleep mode.

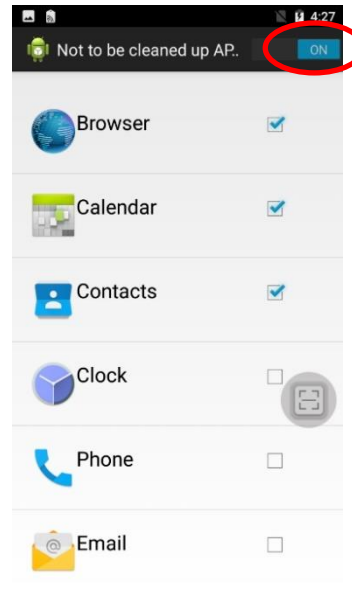
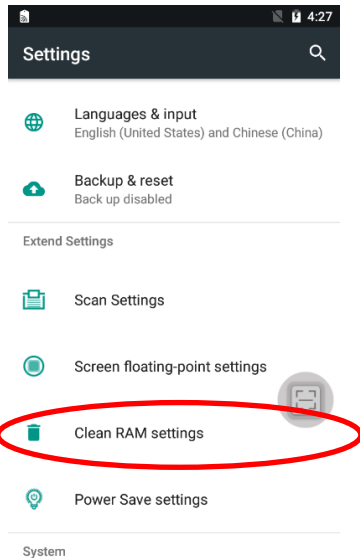

Power Saving Settings

If the “Screen Backlight Dim” feature is ON, the screen will go dim to save the battery when the terminal scans barcodes continuously for 2-3 minutes. To brighten it, press any key on the terminal or tap the screen.

Turn on Screen Backlight Dim: Tap the app icon  -> “Power Save setting” -> tap the ON/OFF slider to ON.

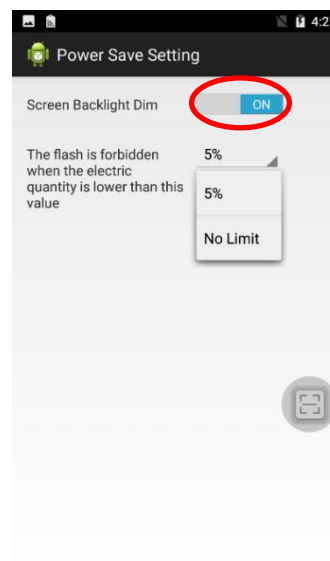
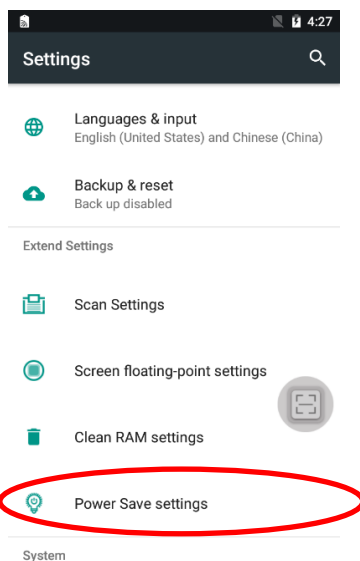

Shortcuts to Apps

Create a shortcut to an app on your Home screen: Tap  on the Home screen. Tap and hold your desired app and then drag it into the Home screen.

Widgets

View all widgets: Tap and hold on a blank area of the Home screen and then tap  .

Open a widget: Tap it.

Add a widget icon to the Home screen: Tap and hold the Home screen and then tap  . Tap and hold your desired widget and then drag it into the Home screen.

Chapter 4 Scanning Barcodes

Introduction

This chapter includes scanning tips and instructions for setting up the scanner.

Scanning 1D Barcode

Adjust the scan angle or the distance between the MT90 and the target barcode to ensure the length of laser beam is roughly 8mm greater than that of the barcode, as shown below.



Correct	Wrong



Scanning 2D Barcode

Adjust the scan angle and the distance between the MT90 and the target barcode to make them fall into the following ranges:

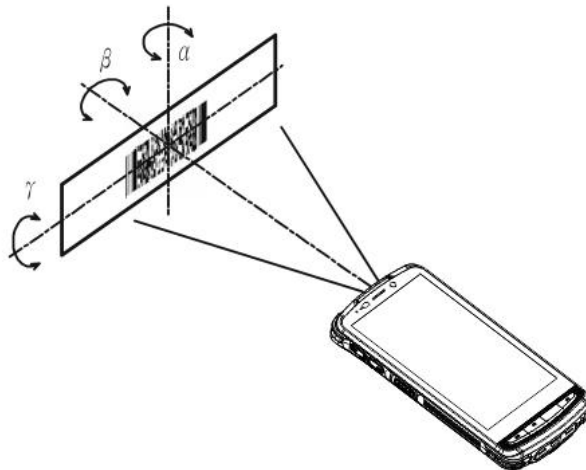
- 1) Point the MT90's focus lamp at the center of the barcode.
- 2) Move the MT90 until you find the appropriate scan distance.
- 3) Optimum scan angles:
Skew (α) < 45° (0° preferably)
Pitch (γ) < 45° (5° - 20° preferably)
Roll (β) = 0° - 360°



Programming Scanner

Tap the app icon  then “Scan Settings”, or tap the app icon  on the Home screen then . Then configure the scanner parameters as per your actual needs.

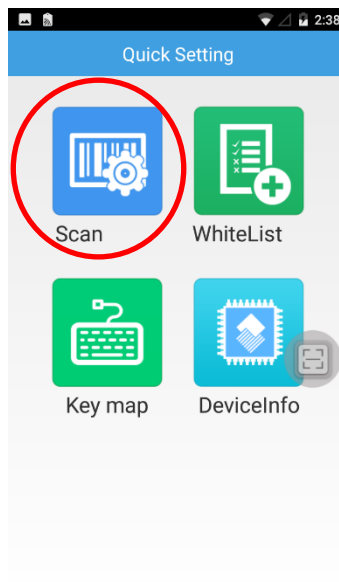
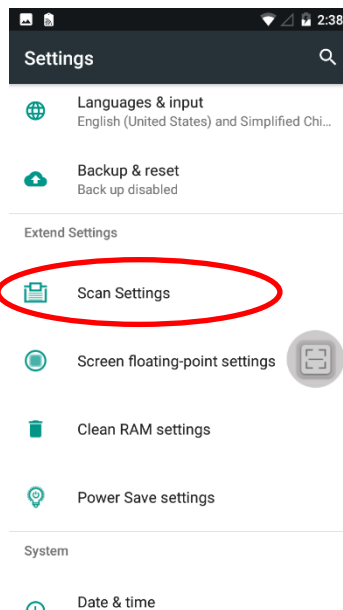

Enable Scan

Check or uncheck the “Enable scan” item to enable or disable the scanning feature of the MT90

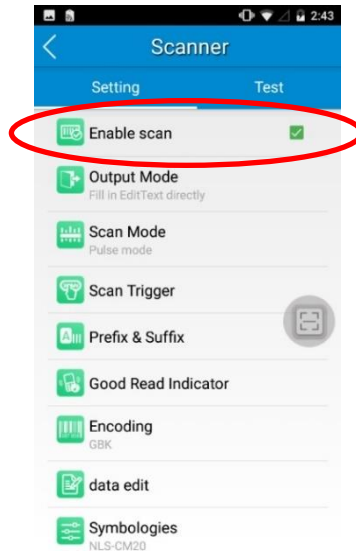

Output Mode

The MT90 provides three output modes: Simulate keystroke, Output via API and Fill in EditText directly.

1. **Simulate keystroke:** Output scanned data to keyboard buffer to simulate keyboard input.

Character interval (ms): A character interval of 0-100 milliseconds may be placed between the transmission of each character of scanned data.

2. **Output via API:** Application acquires scanned data by receiving system broadcasts.

3. **Fill in EditText directly:** Output scanned data at the current cursor position in EditText.

Overwrite output: Clear the text input box before sending the barcode currently scanned to make sure only most recently scanned data is present in the text input box. This feature is available only when **Simulate keystroke** or **Fill in EditText directly** is selected.

Output enter-event: Send an Enter Key after each barcode scanned.

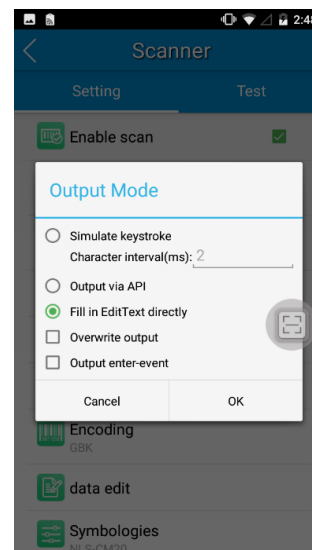
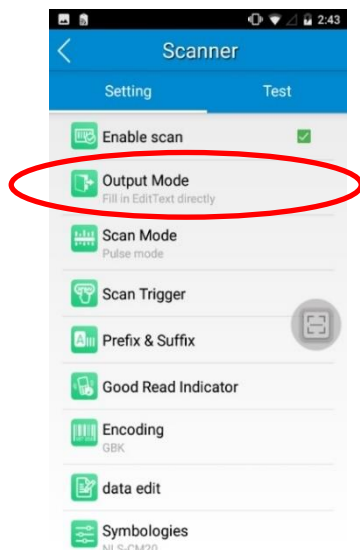

Scan Mode

The MT90 provides three scan modes: Level mode, Continuous mode and Pulse mode.

1. **Level mode:** Press and hold the scan trigger to start a decode session which continues until the trigger is released or the decode session timeout expires or a barcode is decoded.
2. **Continuous mode:** Press the scan trigger to continuously read barcodes. To suspend or resume scan operation, simply press the scan trigger.

Scan interval (ms): This parameter sets the timeout between decode sessions.

Masked repeat interval (ms): This parameter sets the time period before the scanner can read the same barcode a second time.

3. **Pulse mode:** Press the scan trigger to start a decode session which continues until the decode session timeout expires or a barcode is decoded.

Decode session timeout (ms): This parameter sets the maximum time decode session continues during a scan attempt.

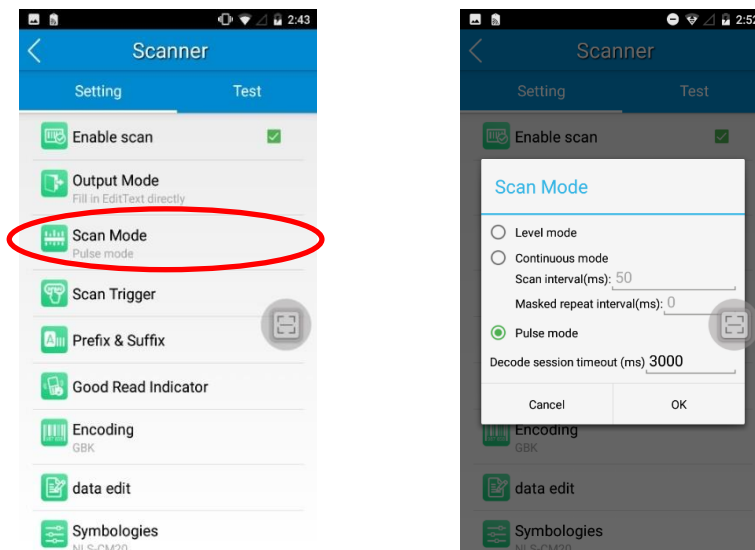

Scan Trigger

The three scan keys on the terminal and the trigger on the pistol grip can all serve as scan trigger. Enable or disable them as per your actual needs.

1. **SCAN key:** Use the Scan key on the front panel of the terminal as scan trigger.
2. **Left/Right SCAN key:** Use the Scan key on the left/right side of the terminal as scan trigger.
3. **Background SCAN key:** Use the trigger on the pistol grip attached to the terminal as scan trigger.

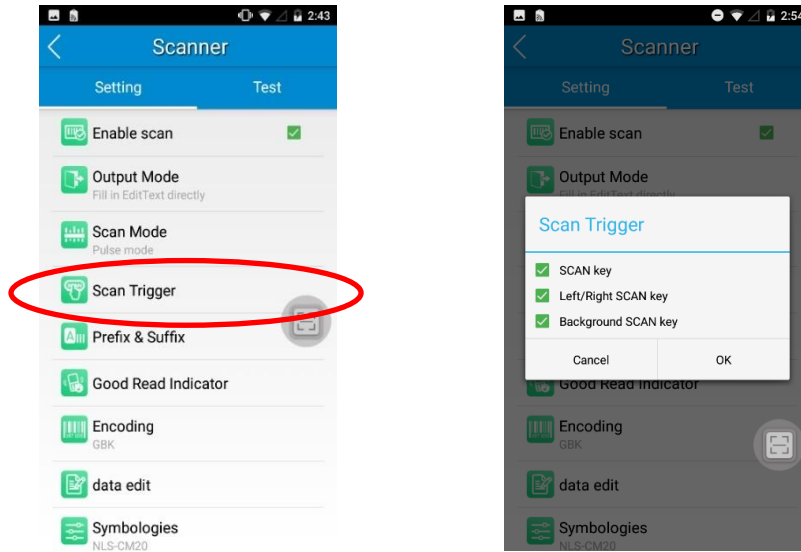

Prefix & Suffix

To set the prefix/suffix, enter the hexadecimal value of a desired prefix/suffix and then tap “OK”. For example, if you want to add a Line Feed character after each barcode, set the suffix to “0A”; if you want to add a Carriage Return character after each barcode, set the suffix to “0D”.

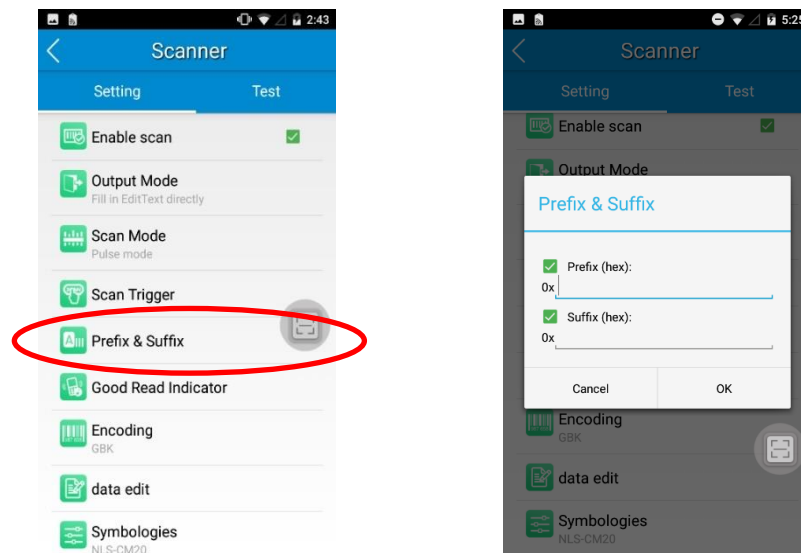

Good Read Indicator

The terminal can use sound/ vibration/ LED to indicate a good read. Choose one or more options as per your actual needs.

1. **Sound:** The MT90 issues a short beep to indicate a good read.
2. **Vibrating:** The MT90 vibrates to indicate a good read.
3. **LED:** The blue LED on the MT90 flashes once to indicate a good read.

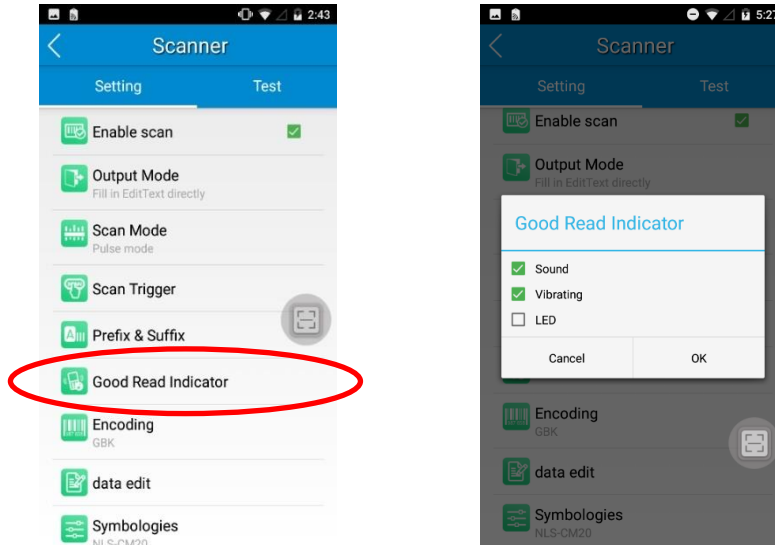

Encoding

Choose a character encoding to interpret barcode data.

1. **UTF-8:** Dominant Unicode encoding.
2. **GBK:** A character encoding for Chinese characters.
3. **ISO-8859-1:** A common character encoding which covers Western European languages.

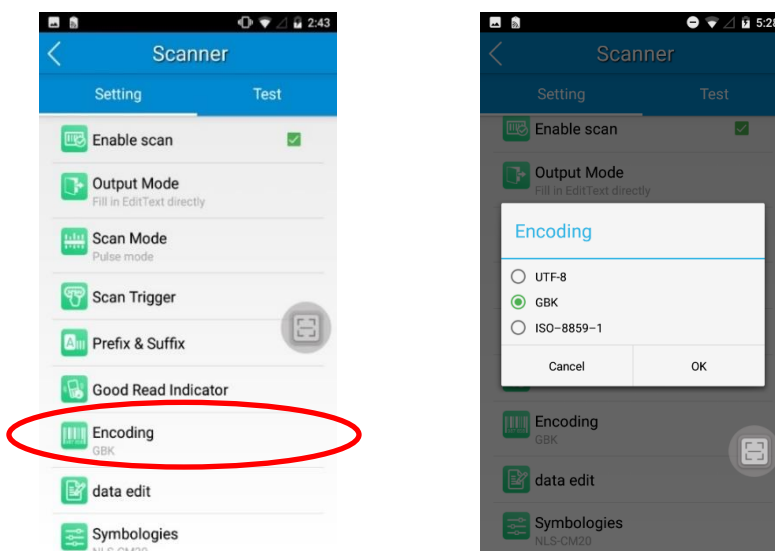

Data Edit

This feature allows you to edit barcode data with a script.

Tap “load script” and then select the desired script file on the terminal, or scan the 2D barcode that contains a script, to load the script. Then select “exec script” and tap “OK”.

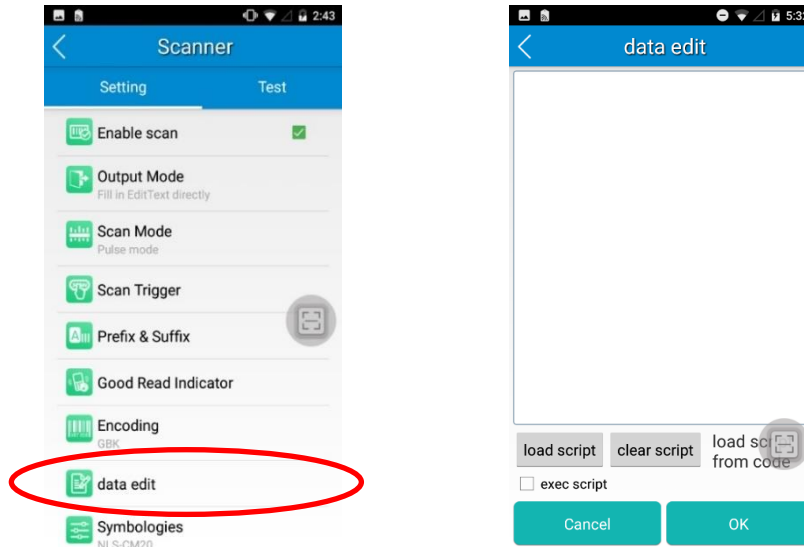

Symbologies

1D code: Enable or disable 1D symbologies and set other barcode parameters.

2D code: Enable or disable 2D symbologies and set other barcode parameters.

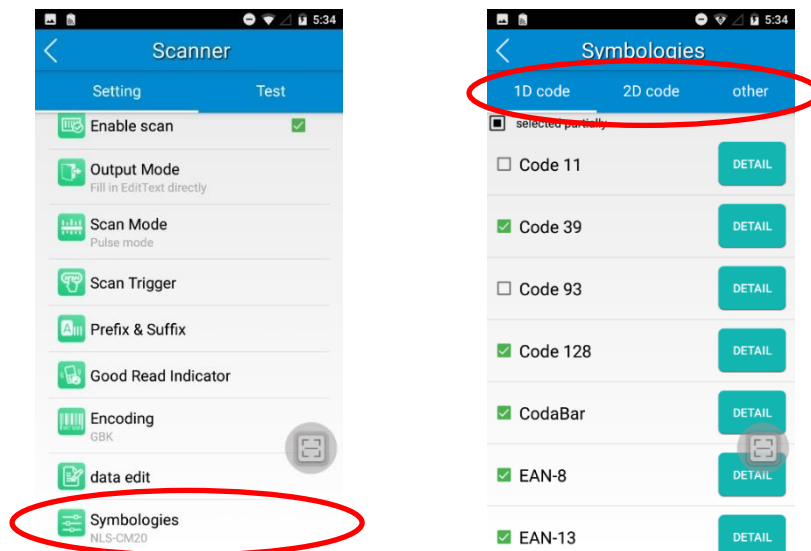

Other: The features listed here are designed to improve the scanning performance and energy efficiency of the terminal.

1. **Central area decoding:** When selected, the terminal only decodes the barcode aimed squarely by the aiming pattern. It is advised to select it to insure that only the desired barcodes are read if multiple barcodes are placed closely together.
2. **Noise reduction:** This feature is designed to reduce noise in images produced by the terminal. However, the terminal shows a slight decrease in scanning speed when using this feature.
3. **Exposure level**
 - DOF preferred:** Select this option when you prefer a larger DOF (depth of field).
 - Motion tolerance preferred:** Select this option when you scan barcodes on a moving object.
 - Auto adaptive:** Select this option when you want the terminal to automatically adjust the exposure while balancing its DOF and motion tolerance.
4. **Power plan:**
 - Power saving:** The terminal's built-in scanner turns off automatically after 3 seconds of inactivity.
 - High-performance:** The terminal's built-in scanner turns off automatically after 15 seconds of inactivity.

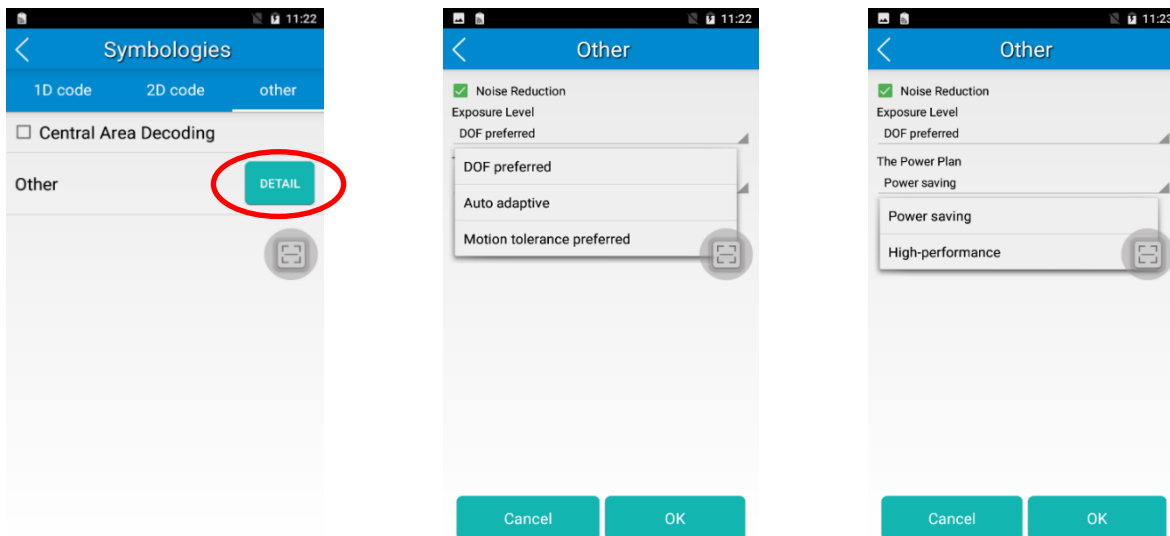

Chapter 5 Bluetooth



This chapter describes how to connect the MT90 to other Bluetooth device.

You can set up a Bluetooth connection between the MT90 and other Bluetooth devices, such as PC, mobile phone. Note that Bluetooth connection works better if there are no obstacles between them.

Before you can use a Bluetooth device with the MT90, you must first pair them.

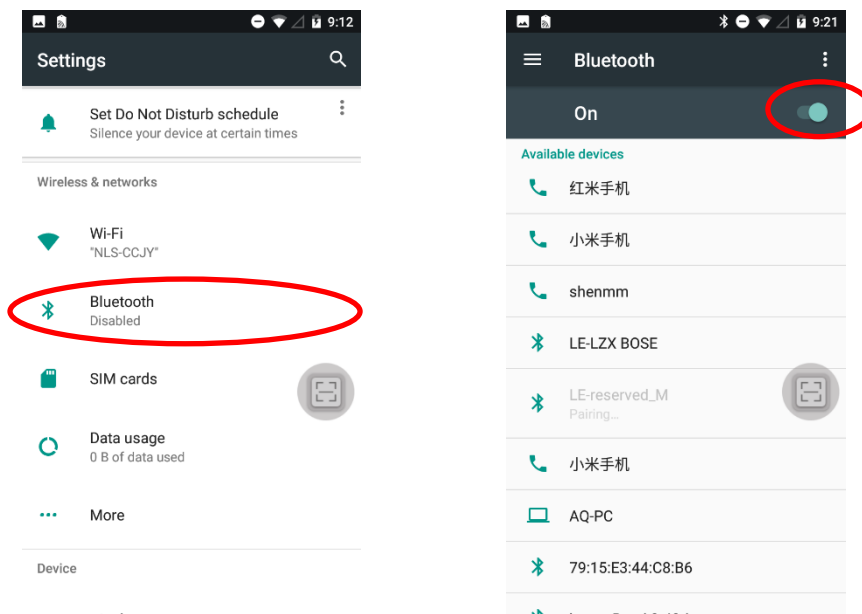
1. Make the Bluetooth device visible to the MT90.
2. Tap the app icon  then “Bluetooth”, and turn Bluetooth on to search for available Bluetooth devices.
3. Select the device from the search results to pair.
4. If prompted, input the pairing code and then tap “OK”; or if the pairing code is given automatically, then tap “PAIR”.



Unpair/rename a paired Bluetooth device: Tap the app icon  then “Bluetooth”, and turn Bluetooth on. Tap  beside the paired Bluetooth device. To rename the paired Bluetooth device, edit its name manually and then tap “OK”. To unpair it, tap “FORGET”.

Chapter 6 Wi-Fi

Introduction

This chapter describes how to connect the MT90 to a Wi-Fi network.

Wi-Fi Settings

Join a Wi-Fi network:

1. Tap the app icon  then “Wi-Fi”, and turn Wi-Fi on to find available Wi-Fi networks. If Wi-Fi is already ON, then the terminal will automatically scan for available networks.
2. Tap a network and then enter the password.
3. Tap “CONNECT”.

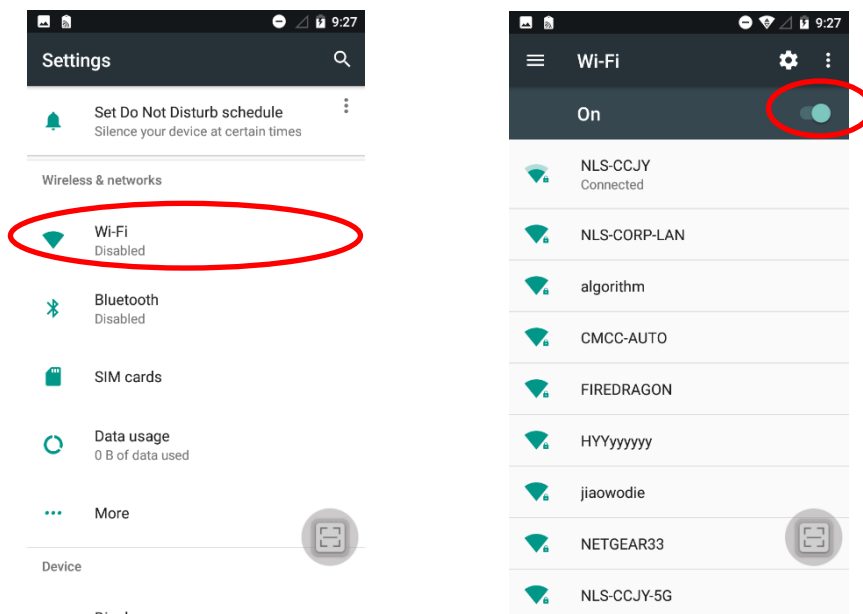

IP Settings

To set the IP, follow the first two steps of joining a Wi-Fi network, check the “Advanced options” item, tap “DHCP” and choose your desired option.

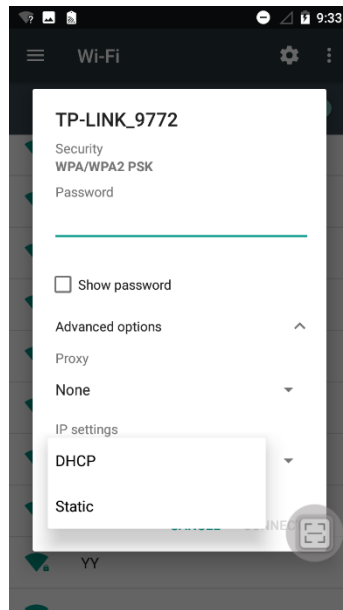

Chapter 7 Mobile Network

Introduction

The MT90 can also use 4G network to connect to the internet. To establish 4G connection, you must have a SIM card installed in your MT90.

Mobile Network Settings

If no Wi-Fi networks are available, or if you've turned Wi-Fi off, then the MT90 connects to the Internet via your cellular data network when available.

Turn on cellular network: Tap  and then turn Cellular data on.

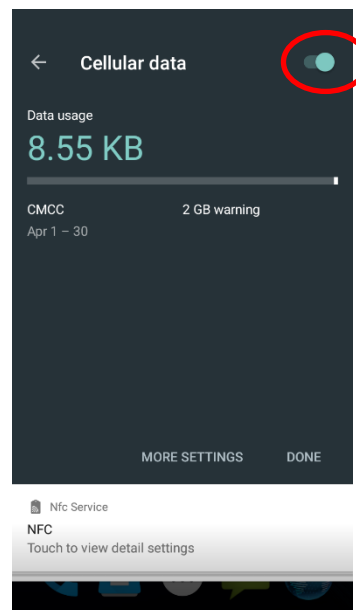
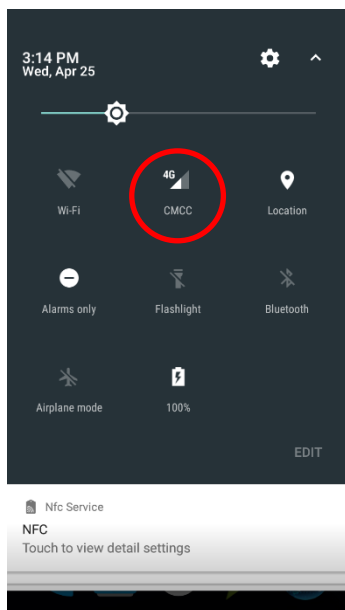

APN Settings

If you cannot connect to the internet when using your terminal's cellular data, you may need to change your APN settings on the MT90 to fix it:

1. Go to Settings -> More -> Cellular networks -> Access Point Names.

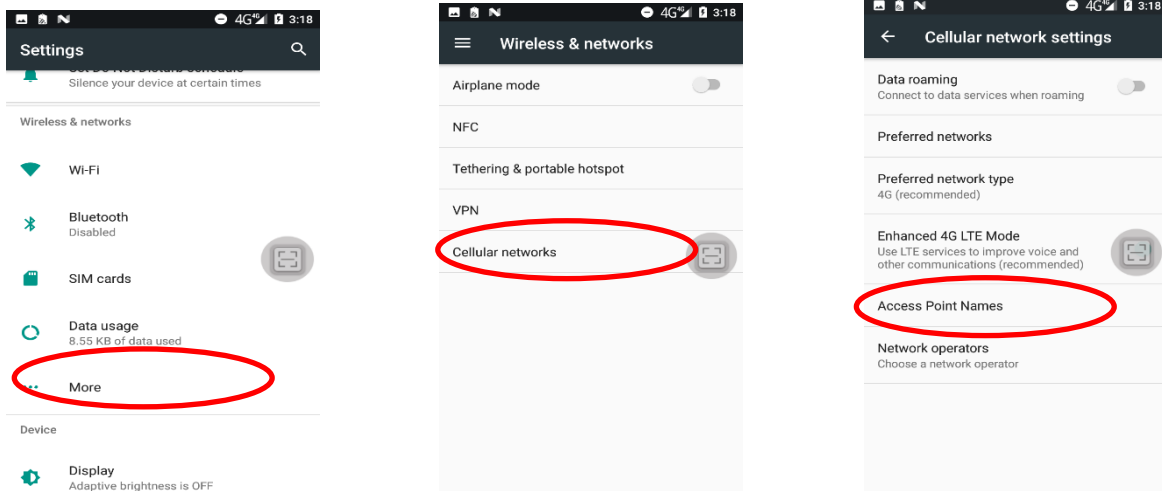

2. Tap  in the top right corner of the screen or tap the carrier of your SIM card on the screen. Then manually enter the APN settings. You can contact your carrier or visit their website to get the correct APN settings, or check the APN settings on a mobile device that can access the internet using the SIM card.

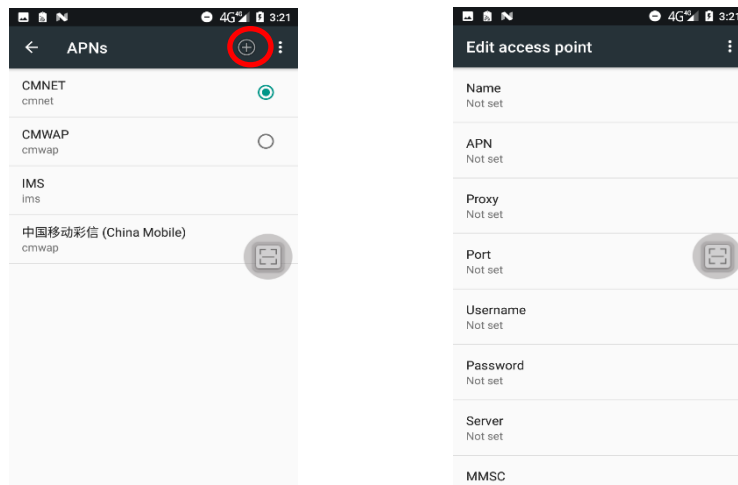

3. Press the Return key on the MT90 to go back to the previous screen and then select the APN you just added.

Chapter 8 Admin Tool

Introduction

The Admin Tool app is used to specify the apps that users can run on the MT90.

Setting the Admin Password

When you use the admin tool for the first time, you will be asked to set the admin password.

Tap the app icon . Enter the password and tap “OK”. Then you will log into the admin tool.

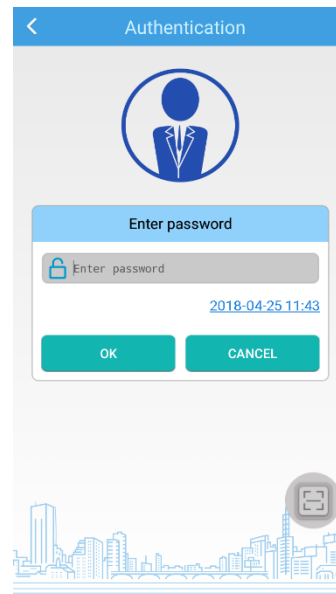
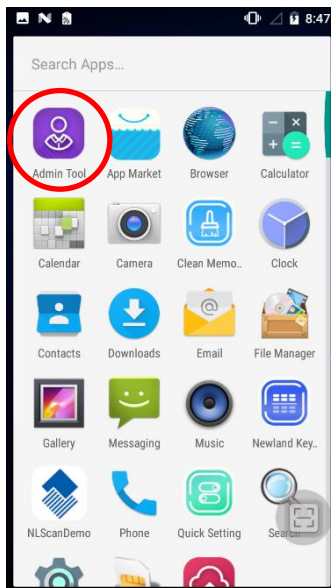

Setting the Admin Mode

After logging into the admin tool, you may set the following parameters as per your actual needs.

1. **App Manager:** Select or deselect the apps available to normal users.
2. **Reset Password:** Change the Admin password.

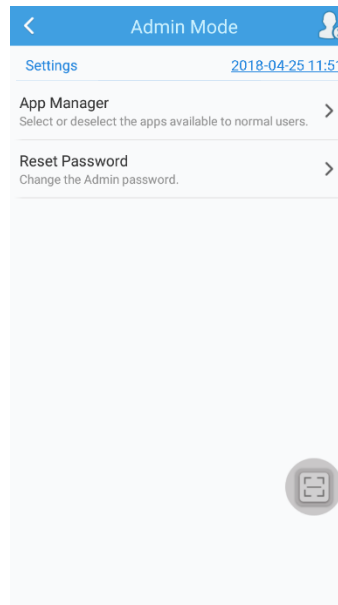

Entering/Exiting the User Mode

To enter the User mode, tap  in the top right corner of the screen.

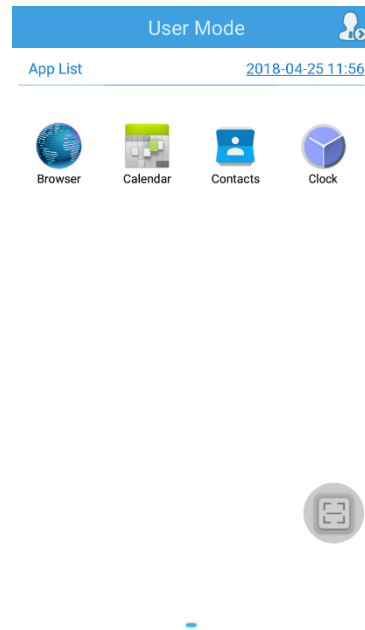
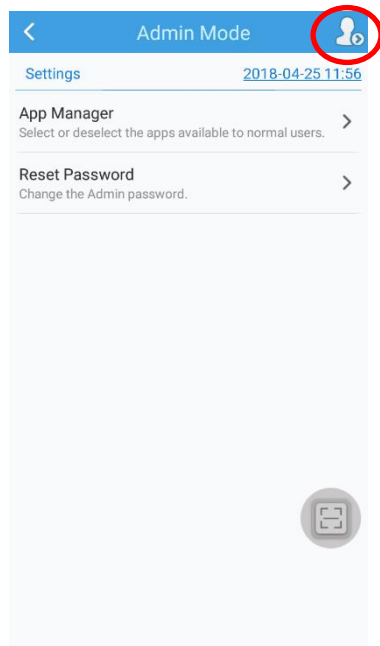

To exit the User mode, press the Return key on the front panel, enter the Admin password and tap “OK”.

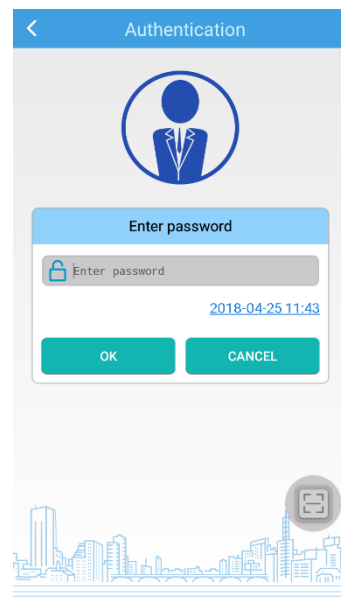
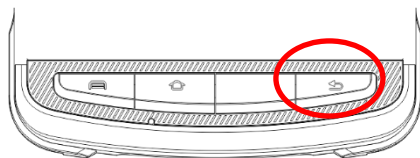



Chapter 9 Whitelist Manager

Introduction

The Whitelist Manager app is used to specify the apps that users can install on the MT90.

Logging in Whitelist Manager

Tap the app icon  on the Home screen then , enter the password (default: 112233), and tap “Login” to log in the whitelist manager. Then set the whitelist manager as per your actual needs.

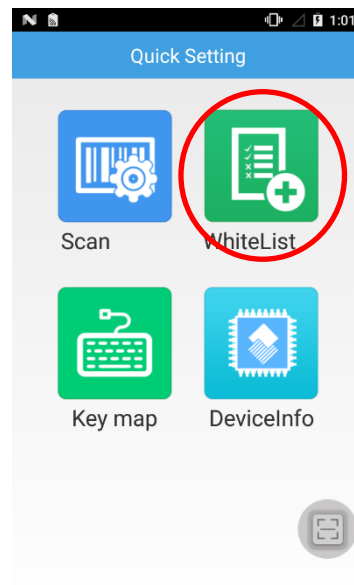
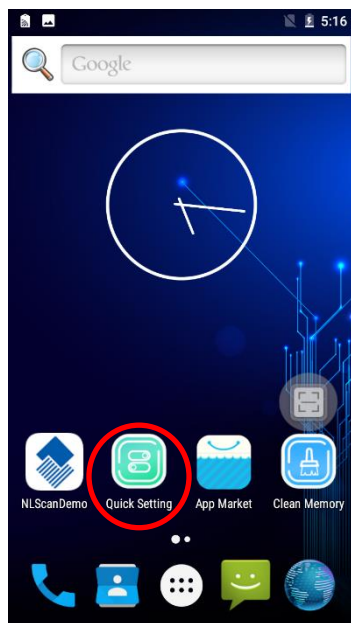

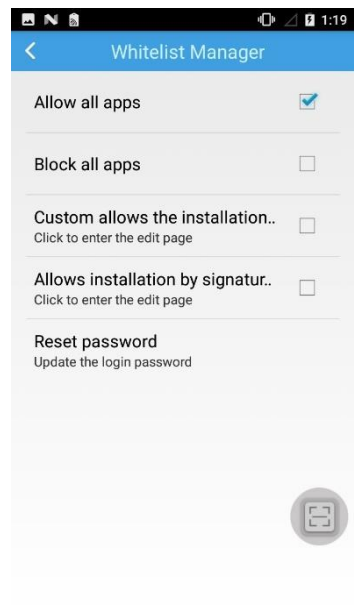
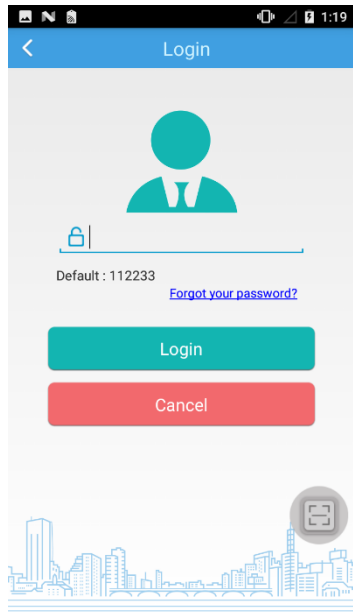



Chapter 10 Others

Camera

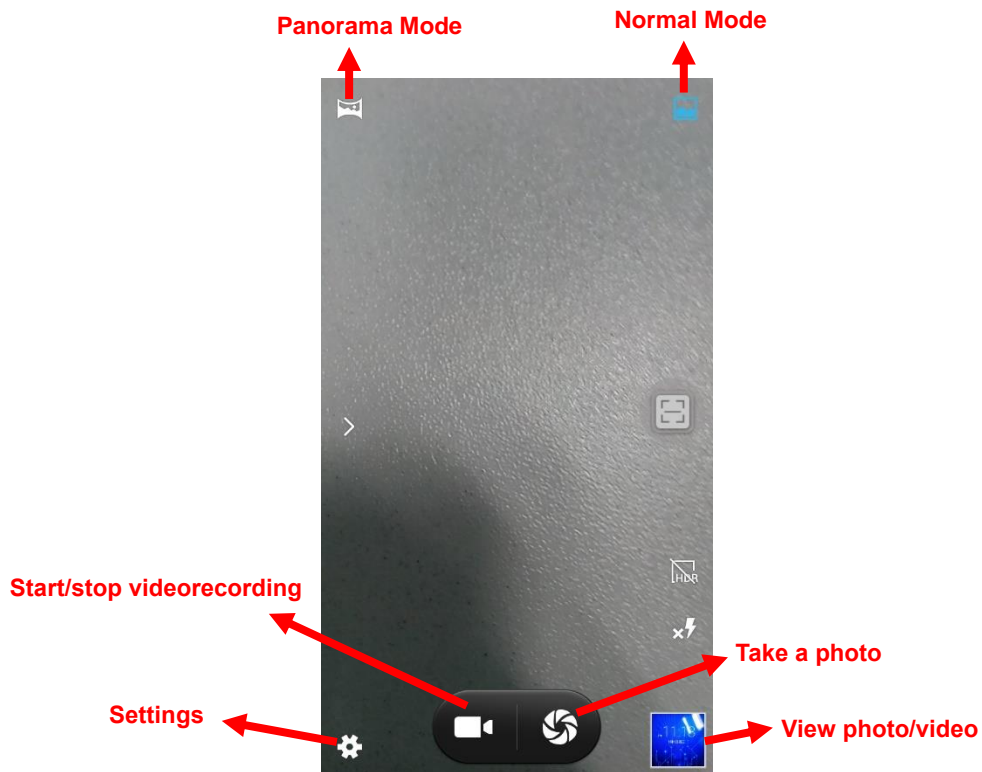
Tap the app icon  to launch the Camera app.



: Tap it to reveal the parameters such as GPS location info, face beauty, exposure, scene mode and white balance and set those parameters as per your needs.

: Tap it to take a photo.

: Tap it to start/stop a video recording.

: Tap the thumbnail image in the bottom right corner of the screen to view the photo or video saved.

You can also download a camera app from the Internet or develop an app for the camera feature.

GPS



Tap the app icon then “Location”, and then:

1. Turn Location on.
2. Tap “Mode” and then choose a location mode as per actual need.
3. Use a third-party map app or other GPS app to obtain location information.

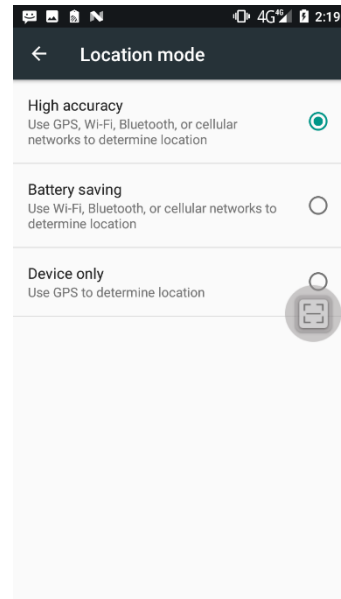
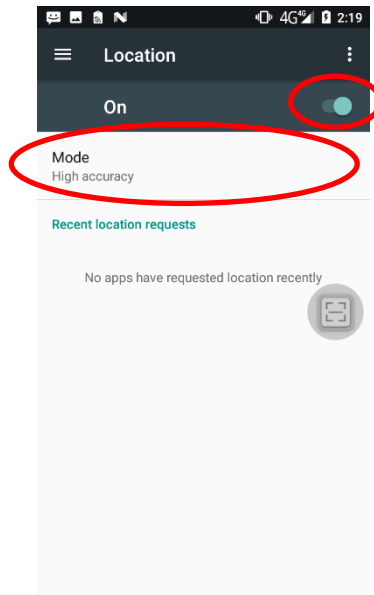
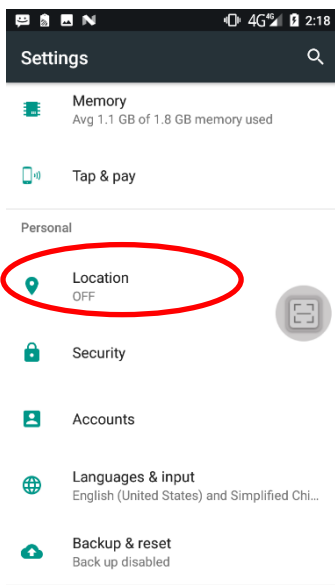

NFC (optional)



To enable the NFC feature, tap the app icon  -> "More" -> "NFC", and then turn on NFC.

Then you can install an NFC writer on the MT90 to read and write NFC tags.

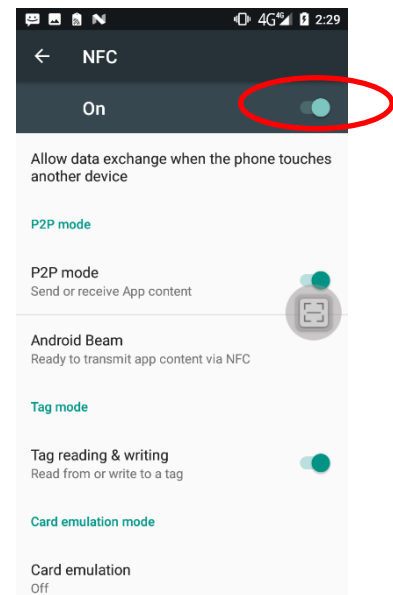
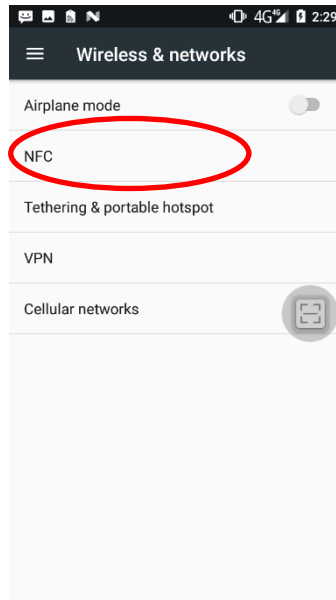
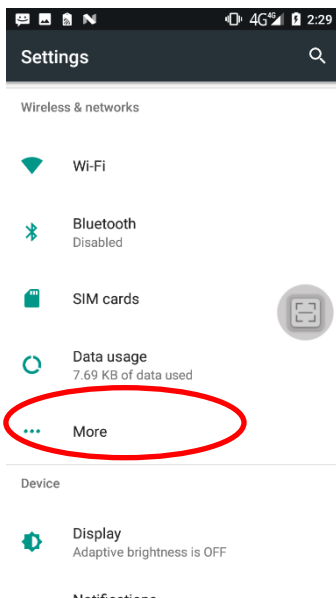

Memory Cleanup

Press and hold the Home key on the keypad until the terminal displays the following screen and then tap  to clean up the memory.

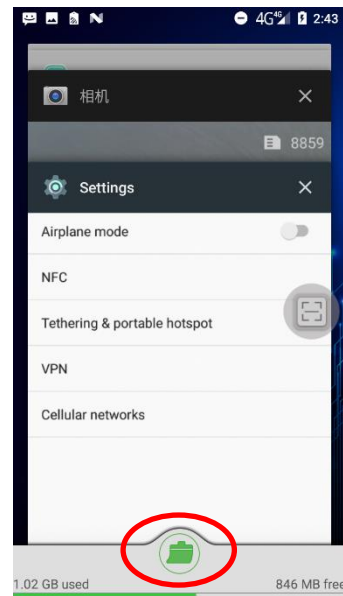
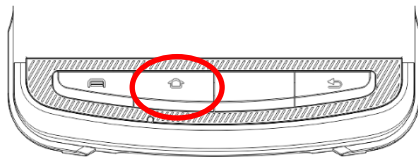

Note: When your terminal becomes less efficiently after having run for extended periods of time, you may perform a memory cleanup or reboot the terminal to fix the problem.

Chapter 11 System Update

Update the system online: Tap  on the Home screen ->  -> "CHECK FOR UPDATES".

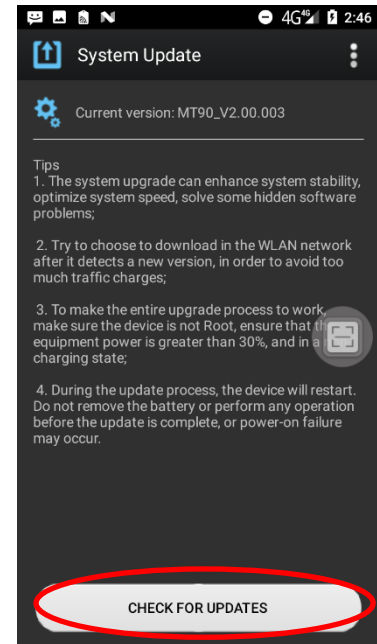
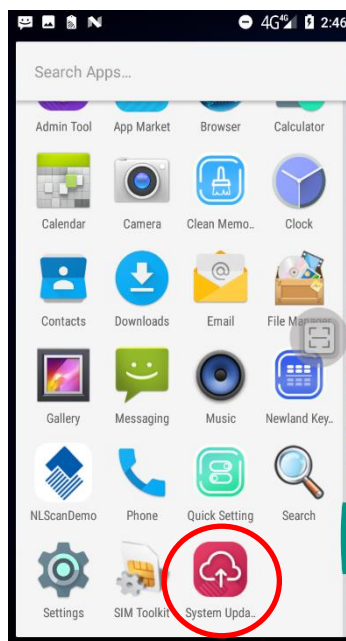

Chapter 12 App Development Guide

Development Environment

The MT90 runs on Android 7.0 operating system, so you should use Android SDK 7.0 or lower when developing apps for the MT90.

Use of Non-standard Interfaces

See *NLS-MT90 SDK Handbook*.

Chapter 13 Maintenance & Troubleshooting

Introduction

This chapter includes important safety and handling information and provides troubleshooting solutions for issues that might occur when using the terminal.

Important Safety & Handling Information

Disassembly and Retrofit

Do not attempt to disassemble or retrofit the terminal yourself. Unauthorized disassembly or retrofit will void the warranty.

External Power Supply

Use only the included AC adapter. Otherwise there is a risk of damage to the terminal.

Abnormal Situation

Keep the terminal away from fire or heat sources. If there is unusual odor, overheating or smoke during charging, immediately cut off the power and disconnect the AC adapter, and contact your dealer or Newland customer service center. Continued use in this case may result in fire or electric shock.

Drop Damage

If the terminal is damaged due to a drop from high place, immediately cut off the power and contact your dealer or Newland customer service center.

LCD Screen

Do not press against or strike the LCD screen. Otherwise it may damage the screen. When handling a cracked or shattered screen, do not touch the liquid that has leaked from it to avoid skin burn or infection.

Stacking Heavy Objects

Do not place heavy objects on the terminal as those objects may fall and cause injury.

Mounting Location

Do not place the terminal on unstable or uneven surfaces as it may fall and cause injury. Do not expose the terminal to humidity or dust as this may cause fire or electric shock. Do not expose the terminal to direct sunlight for extended periods.

Wireless Functionalities

Do not use the terminal's wireless functionalities where wireless device use is prohibited or where it may cause interference or danger, such as in aircrafts, petrol stations.

Use & Maintenance

- ✧ If the terminal cannot be switched on after experiencing a sudden or unexpected power loss or other abnormalities, remove and then reinstall its battery to reset the terminal.
- ✧ Do not throw, drop or strike the terminal. Doing so may damage the LCD display, interrupt running programs, cause data loss in memory and result in malfunction.
- ✧ Clean the scan window regularly. Do not touch it with hands. Scratched or smudged window may degrade reading performance.
- ✧ Do not tap the touch screen with sharp objects. Doing so may damage the screen or cause internal short circuits.
- ✧ Use only a dry soft cloth to clean the terminal. Cleaning it with wet cloth or benzene/ thinner/ other volatile chemicals may deform and shorten the service life of the keypad and shell of the terminal.
- ✧ Do not place the terminal facedown on any surface, or there might be misoperations.
- ✧ Sudden temperature drops may cause condensation on the shell which could cause malfunction. Care should be taken to avoid condensation. If condensation occurs, dry the terminal before use.

Battery Safety Guidelines

- ✧ **Do not dispose of batteries in a fire as they may explode.**
- ✧ The battery can be charged and discharged over 500 times. If the battery life is unreasonably short, please replace the battery with a new one.
- ✧ Use only the included battery and AC adapter.
- ✧ Do not continue to charge a battery that is fully charged. Overcharging will shorten battery lifespan. If a fully charged battery is not used, it will discharge slowly, which does not affect its normal use.
- ✧ Do not use damaged or faulty AC adapters or batteries.
- ✧ **Properly dispose of and recycle batteries. Do not dispose of them as household garbage.**

Troubleshooting

Problem		Possible Cause & Solution
Type	Description	
Keypad	Unresponsive keypad or incorrect response to any key entry.	This problem may be caused by unreliable cable connection between keypad and mainboard or keypad malfunction. Please contact Newland after-sales service.
Battery	Charging LED is OFF when charging.	Ensure the AC adapter is plugged in properly.
	Noticeably short battery life.	<ol style="list-style-type: none"> 1. Check the battery level. If the battery is almost depleted, recharge it. 2. Replace the battery if it is faulty.
	Fully charged battery is depleted after the terminal is switched on.	If the battery is faulty, replace it with a new one.
USB	USB communication failure	<ol style="list-style-type: none"> 1. Ensure that the USB cable connections are secure. 2. Ensure that there is no contaminant inside the Micro USB port. 3. If the problem still remains, please contact the after-sales service center.
LCD Screen	No display	<ol style="list-style-type: none"> 1. Ensure the terminal is switched on. 2. If the terminal is in sleep mode, press the Power key to wake it up. 3. Check the battery level. If the battery is depleted, recharge it. 4. Ensure that the battery is properly installed. 5. Replace the battery if it is faulty. 6. If the problem still remains, please contact the after-sales service center.
System	Cannot switch on	<ol style="list-style-type: none"> 1. Check the battery level. If the battery is depleted, recharge it. 2. Switch the terminal on after using the included AC adapter to connect it to a power outlet. If the problem disappears, then continue to charge the terminal. If the problem remains after charging the terminal for a while, replace the battery.
	System halted	<ol style="list-style-type: none"> 1. The problem may be caused by bugs of downloaded apps. Ensure that only reliable apps are used. 2. The problem may be caused by a sudden or unexpected power loss. Remove and then reinstall its battery to reset the terminal.



Newland

SCANNING MADE SIMPLE

Newland EMEA HQ

+31 (0) 345 87 00 33
info@newland-id.com
newland-id.com

D-A-C-H

+49 (0) 6182 82916-16
info@newland-id.de

Benelux

+31 (0) 345 87 00 33
benelux@newland-id.com

Italy

+39 (0) 342 0562227
italy@newland-id.com

United Kingdom

+44 (0) 1442 212020
sales@newland-id.co.uk

South Africa

Gauteng: +27 (0) 11 553 8010
Cape Town: +27 (0) 21 9140819
info@newland-id.co.za

Turkey

+90 (0) 544 538 40 49
turkey@newland-id.com

France

+39 (0) 345 8804096
france@newland-id.com

Ibérica

+31 (0) 345 87 00 33
info@newland-id.com

Nordic & Baltic

+46 (0) 70 88 47 767
nordic@newland-id.com

Russia

+31 (0) 345 87 00 33
russia@newland-id.com

Middle East

+39 (0) 345 8804096
middleeast@newland-id.com

Iran

+90 (0) 544 538 40 49
iran@newland-id.com