

# TM-U220 Printers

**User's Manual / Bedienungsanleitung  
Gebruikershandleiding / Manuel d'utilisation  
Manual do utilizador / Manual del usuario  
Manuale dell'utente / Руководство пользователя**

404312202

## EMC and Safety Standards Applied

Product Name: TM-U220A/TM-U220B/  
TM-U220D

Model Name: M188A/M188B/M188D

The following standards are applied only to the printers that are so labeled. (EMC is tested using the EPSON power supplies.)

Europe: CE marking  
Safety: TÜV (EN 60950)

North America: EMI: FCC/ICES-003 Class A  
Safety: UL 60950/CSA C22.2  
No. 60950

Japan: EMI: VCCI Class A

Oceania: EMC: AS/NZS 3548 Class B

### WARNING

The connection of a non-shielded printer interface cable to this printer will invalidate the EMC standards of this device.

You are cautioned that changes or modifications not expressly approved by Seiko Epson Corporation could void your authority to operate the equipment.

This class III equipment should be used with an approved power supply with SELV outputs.

### CE Marking

The printer conforms to the following Directives and Norms:

Directive 89/336/EEC	EN 55022 Class B EN 55024 IEC 61000-4-2 IEC 61000-4-3 IEC 61000-4-4 IEC 61000-4-5 IEC 61000-4-6 IEC 61000-4-11
----------------------	---

### FCC Compliance Statement For American Users

This equipment has been tested and found to comply with the limits for a Class A digital device, pursuant to Part 15 of the FCC Rules. These limits are designed to provide reasonable protection against harmful interference when the equipment is operated in a commercial environment.

This equipment generates, uses, and can radiate radio frequency energy and, if not installed and used in accordance with the instruction manual, may cause harmful interference to radio communications.

Operation of this equipment in a residential area is likely to cause harmful interference, in which case the user will be required to correct the interference at his own expense.

### For Canadian Users

This Class A digital apparatus complies with Canadian ICES-003.

## Important Safety Information

This section presents important information intended to ensure safe and effective use of this product. Read this section carefully and store it in an accessible location.

### Key to Symbols

The symbols in this manual are identified by their level of importance, as defined below. Read the following carefully before handling the product.



#### **WARNING:**

*Warnings must be followed carefully to avoid serious bodily injury.*



#### **CAUTION:**

*Cautions must be observed to avoid minor injury to yourself or damage to your equipment.*

## Safety Precautions

### **WARNING:**

Shut down your equipment immediately if it produces smoke, a strange odor, or unusual noise. Continued use may lead to fire. Immediately unplug the equipment and contact your dealer or a Seiko Epson service center for advice.

Never attempt to repair this product yourself. Improper repair work can be dangerous.

Never disassemble or modify this product. Tampering with this product may result in injury or fire.

Be sure to use the specified power source. Connection to an improper power source may cause fire.

Do not allow foreign matter to fall into the equipment. Penetration by foreign objects may lead to fire.

If water or other liquid spills into this equipment, do not continue to use it. Continued use may lead to fire. Unplug the power cord immediately and contact your dealer or a Seiko Epson service center for advice.

### **CAUTION:**

Do not connect cables in ways other than those mentioned in this manual. Different connections may cause equipment damage and burning.

Be sure to set this equipment on a firm, stable, horizontal surface. Product may break or cause injury if it falls.

Do not use in locations subject to high humidity or dust levels. Excessive humidity and dust may cause equipment damage or fire.

Do not place heavy objects on top of this product. Never stand or lean on this product. Equipment may fall or collapse, causing breakage and possible injury.

To ensure safety, unplug this product before leaving it unused for an extended period.

Before moving the product, unplug it and unplug all cables connected to it.

## Safety Label

### **WARNING:**

Do not connect a telephone line to the drawer kick out connector; otherwise, the printer and the telephone line may be damaged.



### **CAUTION:**

During printing or after printing, the print head can be very hot.

## Notes on Usage

- Do not open the cover during printing or when the autocutter is being operated.
- Do not install the printer in a dusty place.
- Protect the printer from impact.
- Cords or other foreign objects must not be caught on the printer.
- Do not apply excessive force to the printer case.
- Do not place food or beverages such as coffee on the case of the printer.

## Notes on Installation

- When using the printer, be sure that the printer is installed horizontally.
- If you are using a Type B or D printer, you can hang it on a wall, using the optional hanging bracket set, WH-10.

**Note:**

*To hang the printer on a wall, see the WH-10 Installation Manual for detailed instructions.*

## Notes on Connecting the Power Supply Unit

Be sure to use the correct power supply unit as listed below:

TM-U220 alphanumeric model (types A, B, and D)	TM-U220 multilingual* model (types A, B, and D)
"AC adapter, C" (packed with the alphanumeric model) or "PS-180" (option)	"PS-180" (packed with the multilingual* model)

**Note:**

*The "AC adapter, C," which is packed with the alphanumeric model, cannot be used with the multilingual\* model. Be sure to use the "PS-180" with the multilingual\* model. If the "AC adapter, C," packed with the alphanumeric model, is connected to the multilingual\* model by mistake, the printer might not operate correctly. For example, printing might stop before all the lines are printed or the printer might print the same line repeatedly.*

\*Multilingual means the printer model that can print any one of the following: Japanese Kanji, Simplified Chinese, Traditional Chinese, Thai characters, or Korean characters.

## Purpose of This Manual

This manual provides information to operators of the TM-U220 to describe basic operations to enable safe and correct use of the printer.

---

## Features of Printer Types

See illustration **A**.

	Type A	Type B	Type D
Two color printing	Yes	Yes	Yes
Autocutter	Yes	Yes	No
Take up device	Yes	No	No
Paper width (mm)	76	76/69.5/57.5	76/69.5/57.5
Interface	Serial or parallel	Serial or parallel	Serial or parallel
Characters supported	Alphanumeric	Alphanumeric	Alphanumeric

## Illustrations

Because this manual covers three types of the TM-U220, some of the illustrations may be slightly different from your printer; however, the instructions cover all types, except as noted.

---

## Unpacking

The following items are included for the standard specification printer. If any item is damaged, contact your dealer.

- Printer
- Roll paper
- Exclusive ribbon cassette [ERC-38(B/R)]
- AC adapter (May not be included with the printer.)

---

## Control Panel (LEDs and Buttons)

See illustration **B**.

### LEDs

#### POWER

Lights when the power is on and is off when the power is off.

#### ERROR

Lights when the printer is offline (when the roll paper is at the end, or the roll paper cover is open). Off when the printer operates correctly.  
Flashes when an error occurs. (See the Troubleshooting section.)

#### PAPER OUT

Lights when roll paper is out or nearly out.

## Buttons

### FEED

FEED feeds the roll paper.

**Note:**

*Paper cannot be fed by using this button when a paper out is detected.*

---

## Power Supply Switch and Power Supply Switch Cover

The power supply switch is on the front of the printer. Press the power supply switch to turn on the printer.

### Power Supply Switch Cover

You can use the enclosed power supply switch cover to make sure that the power supply switch is not accidentally pressed. Just press the cover into place to install it. If you need to turn the power supply switch on or off with the cover attached, you can insert a thin tool into one of the holes in the cover to operate the switch. See illustration **C**.

 **WARNING:**

*If an accident occurs when the power supply switch cover is attached, immediately unplug the power supply cable to avoid fire.*

If you are going to store the printer or leave it unused for a long time, turn it off using the power supply switch on the printer.

---

## Inserting and Replacing the Ribbon Cassette

  **CAUTION:**

*The print head becomes very hot during printing. Allow it to cool before you replace the ribbon cassette.*

 **CAUTION:**

*Never turn the ribbon cassette's feed knob in the opposite direction of the arrow marked on the cassette; otherwise the ribbon cassette may be damaged.*

**Note:**

*Use the EPSON ERC-38 ribbon cassette for your printer.*

1. Open the ribbon cassette cover by using the tabs on the sides of the cover, as shown in illustration **D**.
2. Turn the knob two or three times in the direction of the arrow, as shown in illustration **E**.

3. Insert the ribbon in the position shown in illustration **F** and push the ribbon cassette down until it clicks.

**Note:**

*Make sure the ribbon is installed between the print head and the platen without wrinkles or creases.*

4. Again turn the ribbon cassette's knob 2 or 3 times in the direction of the arrow and close the ribbon cassette cover.



**CAUTION:**

*Be careful not to touch the print head with your fingers when turning the ribbon cassette knob because the print head is hot and you might be burned.*

When you replace the ribbon cassette, lift the left side of the ribbon cassette first; then lift the whole ribbon cassette.

---

## Inserting Roll Paper



**CAUTION:**

*Be sure to use roll paper that meets the specifications.*

*Be sure not to touch the manual cutter. Otherwise your fingers might be injured.*

1. Using scissors, cut the leading edge of the roll paper, as shown in illustration **G**.
2. Turn on the printer and open the roll paper cover by using the tab, as shown in illustration **H**.
3. **Type A only:** Open the unit by using the unit open lever, as shown in illustration **I**.
4. Insert the roll paper, as shown in illustration **J**.

**Note:**

*Note the direction the paper comes off the roll, as shown in the illustration **G**.*

*When using 2-ply roll paper, be sure that the top and bottom sheets are aligned at the paper exit. See illustration **G-a**.*

5. **If you are not using a take-up spool**, pull out a small amount of roll paper and close the roll paper cover; then tear off the paper with the manual cutter. You can skip steps 6 through 11.
6. **Type A only:** When using 2-ply roll paper, pull out the roll paper to the bottom front of the printer as a guide, as shown in illustration **K**.
7. Close the unit, as shown in illustration **L**.

8. Insert the end of the bottom paper (journal paper) into the paper take-up spool, as shown in illustration **M**.
9. Insert the paper take-up spool in the printer. Be sure that the paper is aligned with the spool's flange, as shown in illustration **N**.
10. Feed the paper with the FEED button so that the paper is taken up by the spool.
11. Close the roll paper cover and tear off the roll paper with the manual cutter, as shown in illustration **O**.

**Note:**

*Do not open the roll paper cover during printing or paper feeding.*

*When using the printer, be sure to cut the roll paper with the manual cutter after paper feeding is complete.*

---

## Replacing Roll Paper

1. Open the roll paper cover by using the tab, as shown in illustration **H**.
2. **Types B and D:** Remove the used roll paper core.
3. **Type A only:** Remove the take-up spool, and open the unit by using the unit open lever, as shown in illustration **I**; then remove the used roll paper core.
4. Insert new roll paper. See the section "Inserting Roll Paper".

---

## Troubleshooting

---

### Printing stops before all the lines are printed or the printer prints the same line repeatedly

---

If the correct power supply unit is not used, the printer cannot operate correctly. Make sure the correct power supply unit is connected to the printer, referring to the table below:

The power supply unit that can be used with the TM-U220 alphanumeric model (types A, B, and D)	The power supply unit that can be used with the TM-U220 multilingual* model (types A, B, and D)
"AC adapter, C" (packed with the alphanumeric model) or "PS-180" (option)	"PS-180" (packed with the multilingual* model)

\*Multilingual means the printer model that can print any one of the following: Japanese Kanji, Simplified Chinese, Traditional Chinese, Thai characters, or Korean characters.

---

### No lights on the control panel

---

- Check the power supply cable connections and the power outlet.



---

**ERROR LED is flashing or lit**

---

- ❑ The print head temperature may be too high or low. Wait until the print head cools or warms and the printer resumes printing automatically.
- ❑ Make sure that the roll paper cover is properly closed.
- ❑ Types A and B: The autocutter blade is not in the normal position and the autocutter is locked up. If it is a simple lock-up, the error is corrected automatically. If not, see the instructions below to return the blade to the normal position manually.
- ❑ A paper jam has occurred. To remove the jammed paper, see the instructions below.
- ❑ Be sure to check if the specified power source is used. PA-6xxx and PB-6xxx cannot be used with this printer.
- ❑ Turn off the power, wait several seconds, and then turn it on again. If the error remains, contact your supervisor or a qualified service person.

***Returning the autocutter blade to the normal position***

1. Open the roll paper cover by using the tab, as shown in illustration **H**.
2. Use a ballpoint pen or tweezers to turn the knob of the autocutter in the direction indicated by the arrow until you see a round shaft in the hole, as shown in illustration **P**.

***Removing jammed paper*****CAUTION:**

*The print head becomes very hot during printing. Allow it to cool before you reach into the printer.*

1. Open the roll paper cover by using the tab, as shown in illustration **H**.
2. If you have a **Type A** printer, remove the take-up spool and open the unit by using the unit open lever, as shown in illustration **I**.
3. Remove the jammed paper.
4. Re-insert the roll paper and close the roll paper cover.

## ***EPSON Ecology Label***

This product is in compliance with the EPSON ecology label requirements. Please see the following link for detailed information on label criteria. (<http://www.epson.co.jp/e/>)



**A**

Type A

Type B

Type D

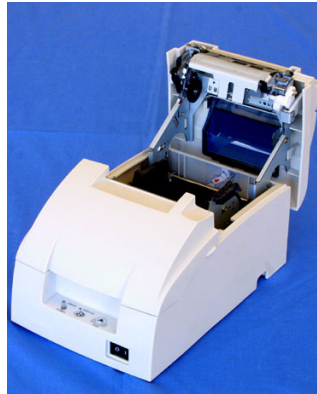
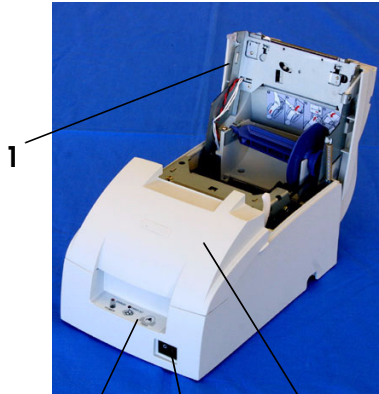

3 4 2

**B**

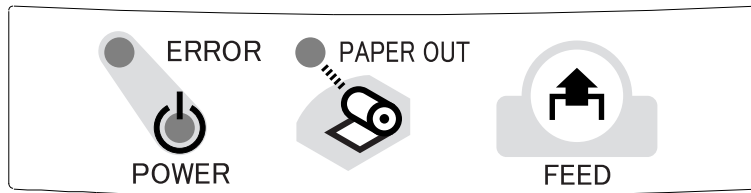

**C**

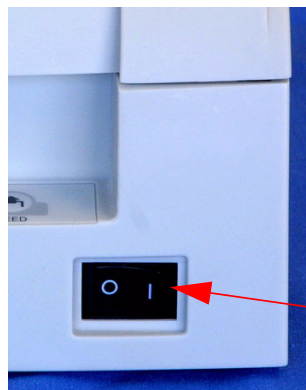

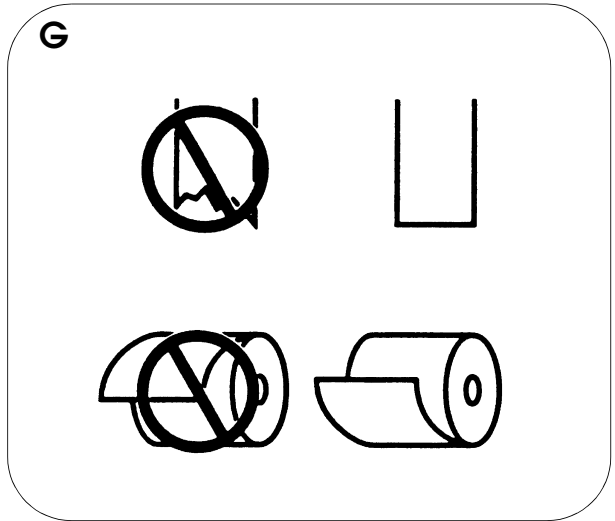
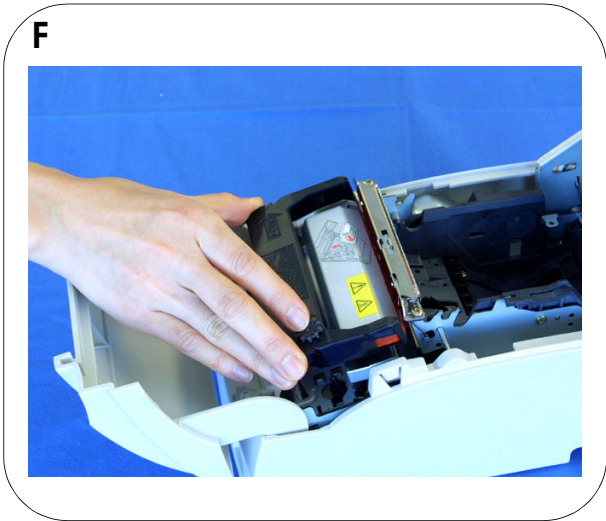
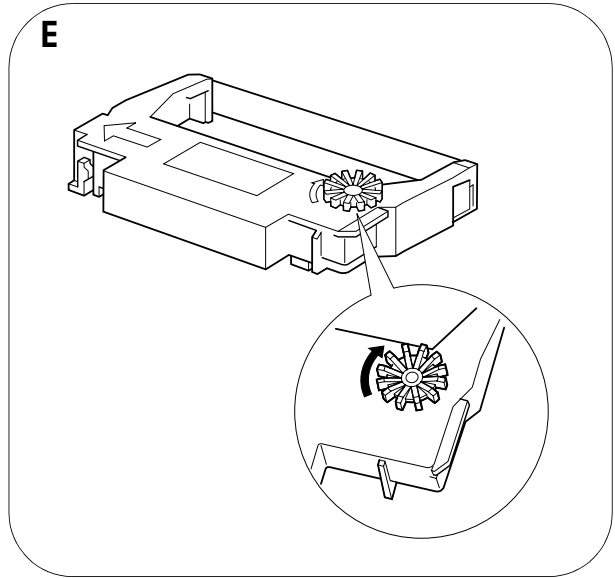
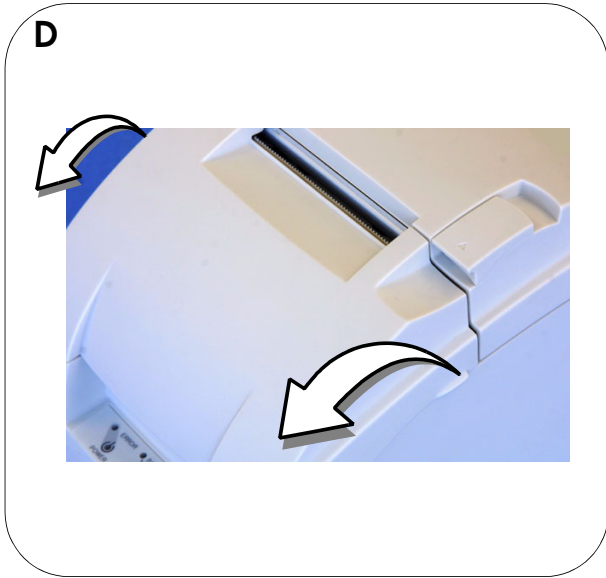

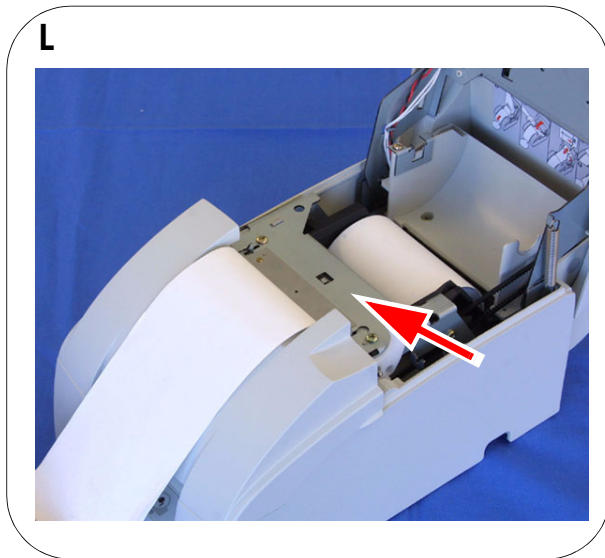
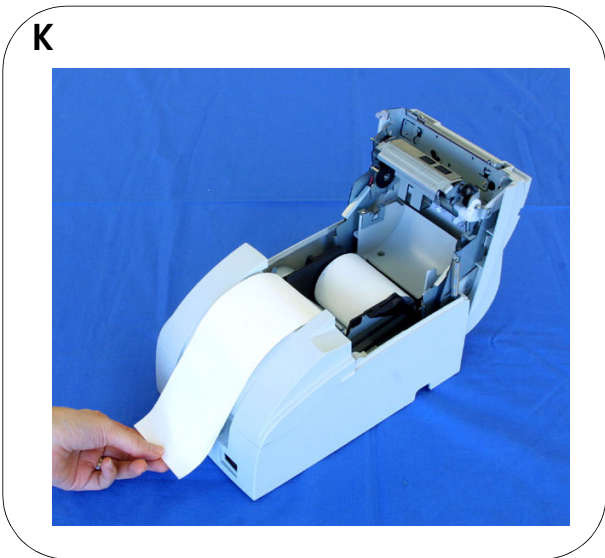
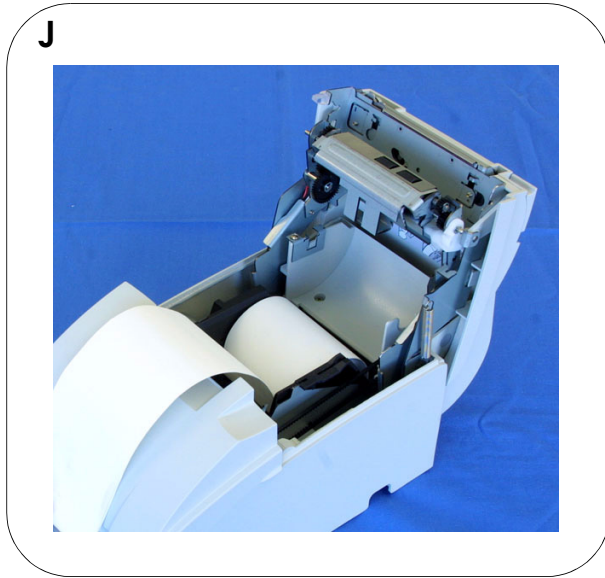
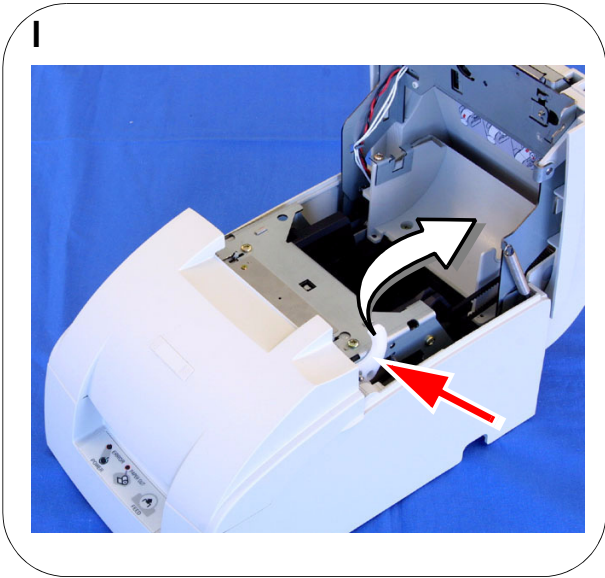

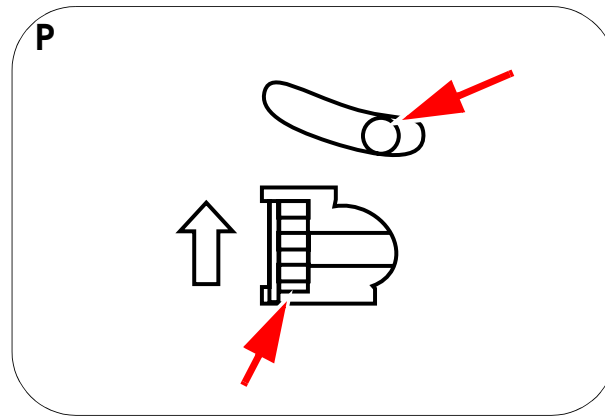
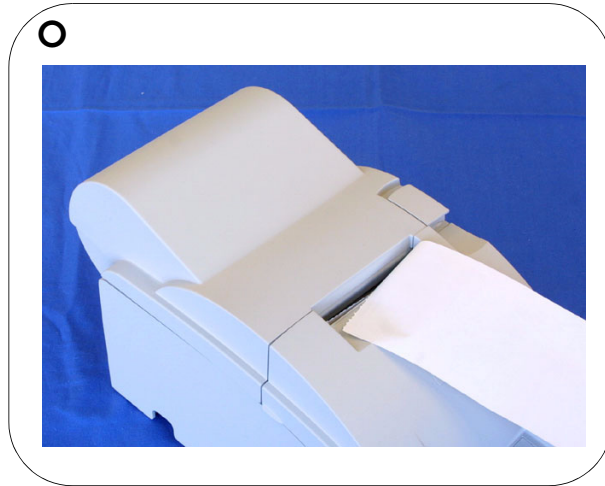

# DIP Switch Tables

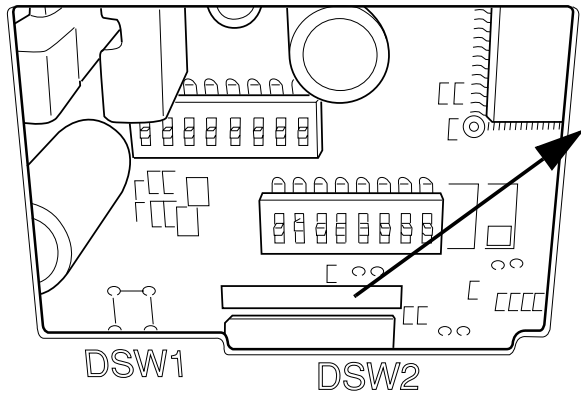

Look at the numbers and letters in the area indicated in the illustration. If the last letters are "US", use the "US" tables below. If the last letters are "STD", use the "STD" tables.

## **!** CAUTION:

Be sure to replace the DIP switch cover before using the printer.

## US

### Serial (DIP Switch 1)

SW	Function	On	Off
1	Data receive error	Ignored	Prints "?"
2	Receive buffer capacity	40 bytes	4 KB
3	Handshaking	XON/XOFF	DTR/DSR
4	Word length	7 bits	8 bits
5	Parity check	Yes	No
6	Parity selection	Even	Odd
7	Transmission speed	4800 bps	9600 bps
8	BUSY condition	Receive buffer full	Receive buffer full or Offline

### Serial (DIP Switch 2)

SW	Function	On	Off
1	Print column	42/35	40/33
2	For internal use only (autocutter)	Enabled	Disabled
3	Pin 6 reset signal	Used	Not used
4	Pin 25 reset signal	Used	Not used
5	Undefined	-	-
6	For internal use only (flash memory rewriting)	Enabled	Disabled
7	Undefined	-	-
8	Serial interface selection	Memory switch	DIP switch

### Parallel (DIP Switch 1)

SW	Function	On	Off
1	Auto line feed	Enabled	Disabled
2	Receive buffer capacity	40 bytes	4 KB
3~7	Undefined	-	-
8	BUSY condition	Receive buffer full	Receive buffer full or Offline

### Parallel (DIP Switch 2)

SW	Function	On	Off
1	Print column selection	42/35	40/33
2	For internal use only (autocutter)	Enabled	Disabled
3	Undefined	-	-
4	Pin 31 reset signal	Used	Not used
5	Undefined	-	-
6	For internal use only (flash memory rewriting)	Enabled	Disabled
7	Undefined	-	-
8	Undefined	-	-

# STD

## Serial (DIP Switch 1)

SW	Function	On	Off
1	Data receive error	Ignored	Prints "?"
2	Receive buffer capacity	40 bytes	4 KB
3	Handshaking	XON/XOFF	DTR/DSR
4	Word length	7 bits	8 bits
5	Parity check	Yes	No
6	Parity selection	Even	Odd
7	Transmission speed	4800 bps	9600 bps
8	BUSY condition	Receive buffer full	Receive buffer full or Offline

## Serial (DIP Switch 2)

SW	Function	On	Off
1	Print column	42/35	40/33
2	For internal use only (autocutter)	Enabled	Disabled
3	Undefined	-	-
4	Serial interface selection	Memory switch	DIP switch
5	Undefined	-	-
6	For internal use only (flash memory rewriting)	Enabled	Disabled
7	Pin 6 reset signal	Used	Not used
8	Pin 25 reset signal	Used	Not used

## Parallel (DIP Switch 1)

SW	Function	On	Off
1	Auto line feed	Enabled	Disabled
2	Receive buffer capacity	40 bytes	4 KB
3~7	Undefined	-	-
8	BUSY condition	Receive buffer full	Receive buffer full or Offline

## Parallel (DIP Switch 2)

SW	Function	On	Off
1	Print column selection	42/35	40/33
2	For internal use only (autocutter)	Enabled	Disabled
3~5	Undefined	-	-
6	For internal use only (flash memory rewriting)	Enabled	Disabled
7	Undefined	-	-
8	Pin 31 reset signal	Used	Not used



## TM-U220 Specifications

<b>Print method</b>		9-pin serial impact dot matrix method
<b>Print font</b>	<b>Font (standard)</b>	Font A: 7 × 9, Font B: 9 × 9
	<b>Column capacity (columns)</b>	7 × 9/9 × 9: 76 mm: 40/33 69.5 mm: 36/30 57.5 mm: 30/25
	<b>Character size (W × H) (standard)</b>	1.2 × 3.1 mm/1.6 × 3.1 mm (not including horizontal spacing)
	<b>Character set</b>	95 Alphanumeric, 48 International, 128 × 12 Graphic
	<b>Characters per inch (standard) (3 half dot spacing)</b>	Font A (7 × 9): 16 cpi, Font B (9 × 9): 13.3 cpi
<b>Paper</b>	<b>Dimensions (mm)</b>	57.5 ± 0.5, 69.5 ± 0.5, 76 ± 0.5
	<b>Normal paper (mm)</b>	Thickness: 0.06~0.085 (1 sheet)
	<b>Pressure-sensitive paper</b>	Thickness: 0.05~0.08 (1 sheet), total thickness must be 0.14 mm or less. Number of copies: Original 1 sheet + one copy sheet
<b>Ribbon cassettes</b>		ERC-38 (B) Black life: 3,000,000 characters ERC-38 (B/R) Black/Red life: Black 1,500,000/Red 750,000 characters Life based on continuous printing at 25°C {77°F}
<b>Print speed (Paper width 76 mm)</b>		4.7 lps (40 columns, 16 cpi)
<b>Interface</b>		RS-232 or IEEE 1284
<b>Data buffer</b>	<b>Receive buffer</b>	4 KB or 40 bytes
	<b>NV bit image data</b>	128 KB
	<b>User NV memory</b>	8 KB
<b>Power supply</b>		24 VDC ± 7%
<b>Power consumption (Stand-by)</b>		2.2 W
<b>D.K.D. function</b>		2 drives
<b>Reliability (Life)</b>	<b>Mechanism</b>	7,500,000 lines
	<b>Print head</b>	150 million characters
	<b>Autocutter</b>	800,000 cuts
<b>Temperature</b>	<b>Operating</b>	0~50°C
	<b>Storage</b>	-10~50°C, without paper and ribbon cassette
<b>Humidity</b>	<b>Operating</b>	10~90%, must be no condensation
	<b>Storage</b>	10~90%, must be no condensation, without paper and ribbon cassette
<b>Overall dimensions (mm)</b>		<b>Type A:</b> 160 × 286 × 157.5 (W × D × H) <b>Type B:</b> 160 × 248 × 138.5 (W × D × H) <b>Type D:</b> 160 × 248 × 138.5 (W × D × H)
<b>Mass (approx.)</b>		<b>Type A:</b> 2.7 kg <b>Type B:</b> 2.5 kg <b>Type D:</b> 2.3 kg

dpi: dots per 25.4 mm (dots per inch); lps: lines per second; lpi: lines per 25.4 mm (lines per inch)

# TM-U220 Printers

## User's Manual

### DIP Switches and Specifications

The technical specifications and the information about the DIP switches are at the beginning of this manual.

### Illustrations

All of the illustrations are at the beginning of this manual. They are identified by letters (A, B, C . . .). In the text the illustrations are referred to by these letters. ("See illustration A," for example.) Some of these illustrations have numbered arrows or lines pointing to parts of the illustration. See the list below for the meaning of the numbers.

#### Illustration A

1. Roll paper cover
2. Ribbon cassette cover
3. Control panel
4. Power supply switch

All rights reserved. No part of this publication may be reproduced, stored in a retrieval system, or transmitted in any form or by any means, electronic, mechanical, photocopying, recording, or otherwise, without the prior written permission of Seiko Epson Corporation. No patent liability is assumed with respect to the use of the information contained herein. While every precaution has been taken in the preparation of this book, Seiko Epson Corporation assumes no responsibility for errors or omissions. Neither is any liability assumed for damages resulting from the use of the information contained herein.

Neither Seiko Epson Corporation nor its affiliates shall be liable to the purchaser of this product or third parties for damages, losses, costs, or expenses incurred by purchaser or third parties as a result of: accident, misuse, or abuse of this product or unauthorized modifications, repairs, or alterations to this product, or (excluding the U.S.) failure to strictly comply with Seiko Epson Corporation's operating and maintenance instructions.

Seiko Epson Corporation shall not be liable against any damages or problems arising from the use of any options or any consumable products other than those designated as Original EPSON Products or EPSON Approved Products by Seiko Epson Corporation.

EPSON is a registered trademark of Seiko Epson Corporation.

**NOTICE:** The contents of this manual are subject to change without notice.

Copyright © 2003 by Seiko Epson Corporation, Nagano, Japan.