

CASIO®

Data Collector
Colector de Datos
Datenerfassungsgerät
Collecteur de Données

DT-810

User's Guide
Guía del usuario
Benutzerhandbuch
Guide de l'utilisateur

- Congratulations upon your selection of the CASIO DT-810 Data Collector.
- Be sure to familiarize yourself with the basic operations described in this manual before actually trying to operate the Data Collector.
- Enhorabuena por la selección del colector de datos DT-810 CASIO.
- Antes de intentar utilizar este colector de datos, familiarícese con las operaciones básicas descritas en este manual.
- Mit dem Datenerfassungsgerät CASIO DT-810 haben Sie eine gute Wahl getroffen.
- Bitte machen Sie sich mit den in diesem Handbuch beschriebenen Grundfunktionen vertraut, bevor Sie beginnen, mit dem Datenerfassungsgerät zu arbeiten.
- Nous vous remercions d'avoir choisi le Collecteur de Données Casio DT-810.
- Veuillez vous familiariser avec les démarches de base, décrites dans le présent manuel, avant d'essayer d'utiliser le Collecteur de Données.



Safety Precautions

Congratulations upon your selection of this CASIO Product. Be sure to read the following Safety Precautions before trying to use it for the first time. Keep this manual in a handy place for future reference.

Markings and Symbols

The following are the meanings of the markings and symbols used in these Safety Precautions to warn you against the possibility of personal injury and/or material damage or loss to you and others. Take a few moments to become familiar with these markings and symbols so you can avoid future problems.



Danger!

This symbol indicates information that, if ignored or applied incorrectly, creates the danger of death or serious personal injury.



Warning!

This symbol indicates information that, if ignored or applied incorrectly, can create the possibility of death or serious personal injury.



Caution!

This symbol indicates information that, if ignored or applied incorrectly, can create the possibility of personal injury or material damage.

Marking examples



A triangular shape indicates you should exercise caution. The symbol shown here indicates you should take care to avoid breakage.



A circle indicates something you should not do. This symbol indicates you should not try to take something apart.



A black circle indicates something you must do. This symbol indicates you should unplug something.

Danger!

■ **Alkaline Battery Handling**



- Alkaline battery fluid getting into your eyes can create the danger of loss of sight or other personal injury. If fluid gets into your eyes, do not rub them. Immediately rinse them with lots of clean tap water, and then consult a physician immediately.

■ **Lithium-ion Battery Pack**

The Lithium-ion Battery Pack is available as an option.



- Never allow the battery pack to become wet with either fresh water or salt water. Water can create the danger of battery pack heat emission, explosion, and fire.
- Never use or leave the battery pack next to open flame, near a stove, or any other area exposed to high heat. Doing so creates the danger of battery pack heat emission, explosion, and fire.
- Never use the battery pack with any device other than this unit. Doing so can create the danger of battery pack heat emission, explosion, and fire.
- Note that the battery pack's positive (+) and negative (-) terminals must be oriented correctly when it is loaded into the charger unit or the Data Collector. Connecting the battery pack with its terminals reversed creates the danger of battery pack fluid leakage, heat emission, explosion, and fire.
- Never dispose of the battery pack by incinerating it or otherwise expose it to heat. Doing so creates the danger of battery pack heat emission, explosion, and fire.
- Never allow the positive (+) and negative (-) terminals of the battery pack to become connected (shorted) by metal. Doing so creates the danger of battery pack heat emission, explosion, and fire.
- Never transport or store the battery pack together with a necklace, hair pins or other metal objects. Doing so can short battery pack terminals, creating the danger of battery pack heat emission, explosion, and fire. Be sure to place the battery pack in its case whenever transporting or storing it.
- Never throw the battery pack or otherwise subject it to strong impact. Doing so creates the danger of battery pack heat emission, explosion, and fire.
- Never pierce the battery pack with nails, hit it with a hammer, or step on it. Doing so can create the danger of battery pack heat emission, explosion, and fire.
- Never try to take apart the battery pack or modify it in any way. Doing so creates the danger of battery pack heat emission, explosion, and fire.



- Use only the specified charger unit to charge the battery pack. Use of another type of charger unit creates the danger of battery pack heat emission, explosion, and fire.

Warning!

■ **Disassembly and Modification**



- Never try to disassemble or modify the unit in any way. High voltage inside creates the danger of electrical shock.

■ **Interior Parts and Components**



- Never touch interior high-voltage parts or components. Doing so creates the danger of electrical shock.

■ **Abnormal Conditions**



- Should the unit become hot or start to emit smoke or a strange odor, immediately turn off power and contact your original dealer or authorized CASIO service provider. Continued use creates the danger of fire and electrical shock.

■ **Foreign Objects**



- Should any foreign matter ever get into the unit, immediately turn off power and contact your original dealer or an authorized CASIO service provider. Continued use creates the danger of fire and electrical shock.

■ **Dropping and Damage**



- Should you drop the unit and damage it, immediately turn off power and contact your original dealer or an authorized CASIO service provider. Continued use creates the danger of fire and electrical shock.

■ **Moisture**



- Keep the unit away from vases, planters, cups, glasses and other containers of liquid. Also keep it away from metal. Water and metal getting into the unit creates the danger of fire and electrical shock.

■ **Laser Beam**



- Never look directly into the laser beam. Doing so can cause serious eye damage.

Warning!

■ **Alkaline Battery and Backup Battery Handling**



- Do not throw batteries into fire, or heat, take apart or modify them. Doing so can damage the insulation or safety valves, and can create the danger of battery leakage, heat emission, and rupture.
- Do not use the battery with its positive (+) and negative (–) terminals reversed. Doing so can cause abnormal reactions by charging and shorting, and can create the danger of battery leakage, heat emission, and rupture.
- Do not connect the positive (+) and negative (–) terminals of the battery with wire, or transport or store the battery with a necklace, hair pins or other metal objects. Doing so can short the battery and cause excessive current to flow, and can create the danger of battery leakage, heat emission, and rupture.
- Do not use new batteries together with already used batteries or different types of batteries. Differences in the battery characteristics can create the danger of battery leakage, heat emission, and rupture.
- Alkaline batteries are not made for recharging. Recharging alkaline batteries damages the insulation and its internal structure, and can create the danger of battery leakage, heat emission, and rupture.
- Do not peel off or scratch the outer label on the battery. Doing so can short the battery, and can create the danger of battery leakage, heat emission, and rupture.
- Do not drop or throw batteries, or subject them to strong impact. Doing so can create the danger of battery leakage, heat emission, and rupture.
- Do not deform batteries. Doing so can damage the insulation or safety valves, and can create the danger of battery leakage, heat emission, and rupture.
- Never charge the backup battery. Doing so can cause the battery fluid to boil or internal pressure to rise due to the generation of gas. This can create the danger of battery leakage, heat emission, rupture, and fire.
- Never directly solder the backup battery. Heat can damage the insulation, and can create the danger of battery leakage, heat emission, rupture, and fire.



- Keep batteries out of the reach of small children. Should small children swallow a battery, consult a physician immediately.
- If you lick alkaline fluid from the battery, immediately rinse with clean tap water, and consult a physician immediately.
- If alkaline fluid from the battery accidentally get onto clothing or your skin, immediate rinse it off with lots of clean tap water. Prolonged contact with battery fluid can cause skin irritation.
- If the backup battery starts to leak or emits a strange odor, immediately move it away from any nearby flame. Leaking battery fluid is combustible.
- When storing and disposing of backup batteries, insulate the terminals with insulating tape. Mixing batteries together or with other metallic objects shorts the battery terminals, and can create the danger of battery leakage, heat emission, rupture, and fire.

Warning!

■ **Lithium-ion Battery Pack**

The Lithium-ion Battery Pack is available as an option.



- Never place the battery pack into a microwave oven or any other high-voltage device. Doing so creates the danger of battery pack heat emission, explosion, and fire.
- Should the battery pack emit a strange odor or heat, change color or shape, or exhibit any other abnormal behavior, immediately stop using it. Continued use creates the danger of battery pack heat emission, explosion, and fire.



- If the battery pack does not achieve full charge after the normal charging time has passed, stop charging. Continued charging creates the danger of battery pack heat emission, explosion, and fire.
- Should the battery pack start to leak or emit a strange odor, immediately move it away from any nearby flame. Leaking battery fluid is combustible, and exposure to flame creates the danger of explosion and fire.
- Should fluid from the battery pack accidentally get into your eyes, do not rub them. Immediately rinse your eyes with clean tap water and then consult a physician immediately.

■ **Optional Optical Communication Unit and Charger Unit**



- Power the Optical Communication Unit and charger unit only with a power outlet whose voltage matches that marked on the Optical Communication Unit and charger unit. Do not plug the Optical Communication Unit and charger unit into an extension shared by other appliances. Doing so creates the danger of fire and electrical shock.
- Avoid conditions that can cause damage or breaks in the power cord. Do not place heavy objects on the power cord and keep it away from sources of heat. Any of these conditions can damage the power cord, creating the danger of fire and electrical shock.
- Never modify, sharply bend, twist, or pull on the power cord. Doing so creates the danger of fire and electrical shock.



- Use only the AC adaptor model and charger specified in this manual. When using the Optical Communication Unit, always use the AC adapter supplied with the Optical Communication Unit. Use of another AC adaptor model or charger creates the danger of fire and electrical shock.
- Should the power cord ever become severely damaged (to the point that wires are exposed or broken), contact your original dealer or CASIO service provider about repair or replacement. Use of a damaged electrical cord creates the danger of fire and electrical shock.

Warning!

■ **Make back-up copies of all important data**



- Note that CASIO Computer Co., Ltd. shall not be held liable to you or any third party for any damages or loss caused by deletion or corruption of data due to use of this, malfunction or repair of this unit or its peripherals, or due to batteries going dead.
- This unit employs electronic memory to store data, which means that memory contents can be corrupted or deleted if power is interrupted due to batteries going dead or incorrect battery replacement procedures. Data cannot be recovered once it is lost or corrupted. Be sure to make back-up copies of all important data. One way to do this is to use the optional Optical Communication Unit to transfer data to a computer.

Caution!

■ **Foreign Objects**



- Take care to ensure that metal or combustible objects are not inserted into the openings of the unit. Such objects create the danger of fire and electrical shock.

■ **Location**



- Do not locate the unit on a surface that is unstable or uneven. Doing so creates the danger of the unit falling or tipping over, which can cause personal injury.
- Do not locate the unit in an area subjected to large amounts of humidity or dust. Doing so creates the danger of fire and electrical shock.
- Do not leave the unit for long periods in a car parked in direct sunlight.

■ **Heavy Objects**



- Never place heavy objects on top of the unit. Doing so creates the danger of loss of balance and the object falling, which can cause personal injury.

■ **LCD Screen**



- Never apply strong pressure to the screen or subject it to strong impact. Doing so can crack the LCD panel glass and create the danger of personal injury.
- Should the LCD panel glass ever break, never touch the liquid inside. Doing so can cause skin irritation and inflammation.
 - Should liquid from the LCD panel accidentally get into your mouth, immediately wash your mouth with water and then consult a physician.
 - Should liquid from the LCD panel accidentally get into your eyes or onto your skin, immediately rinse for at least 15 minutes with clean tap water and then consult a physician.

Caution!

■ **Alkaline Battery and Backup Battery Handling**



- Do not leave batteries in locations subject to strong direct sunlight or in high temperature locations such as in a car. Doing so can create the danger of battery leakage, heat emission, and rupture.
- Do not allow batteries to get wet with water. Doing so can create the danger of heat emission.



- Remove completely used batteries from the equipment immediately. Leaving used batteries for a long time still connected to the equipment can cause gas to be generated from the battery. This can create the danger of battery leakage, heat emission, and rupture, or damage the equipment.
- If batteries are to be used in a completely sealed structure, follow the instructions in the equipment's Instruction Manual.
- If the equipment is not to be used for a long time, back up important data and remove the batteries. Leaving batteries for a long time in the equipment can cause gas to be generated from the battery. This can create the danger of battery leakage, heat emission, and rupture, or damage the equipment.
- When storing and disposing of alkaline batteries, insulate the terminals with insulating tape. Mixing batteries together with other batteries or metallic objects can create the danger of battery leakage, heat emission, and rupture.
- Battery specifications or performance sometimes is not fully achieved depending on how they are used or the equipment they are used on. Correctly use batteries in a way suited to the application in accordance with the equipment's Instruction Manual or precautions.
- Avoid storing batteries in the direct sunlight or in high temperature and humidity locations. Doing so can create the danger of battery leakage, impair battery performance or shorten the service life of the battery.
- Used batteries may be disposed off as general unburnable rubbish. However, dispose of used batteries in accordance with any local bylaws and regulations.
- Use only battery types that are specified for this unit.
- The positive (+) and negative (–) terminals sometimes contact the metallic sections of some equipment near the battery insertion area. Insert batteries into equipment taking care not to short the terminals.

Caution!

■ **Lithium-ion Battery Pack**

The Lithium-ion Battery Pack is available as an option.



- Never leave the battery pack in an area exposed to direct sunlight, in a car parked in direct sunlight, or any other very hot area. Doing so creates the danger of heat emission and fire, as well as deterioration of battery pack performance and shortening of its service life.
- Do not use the rechargeable battery pack in areas where static electricity is being generated. Doing so creates the danger of battery pack heat emission, explosion, and fire.



- Temperature ranges for battery pack use, charging, and storage are specified below. Temperatures outside these ranges create the danger of deterioration of battery pack performance and shortening of its service life, as well as fluid leakage and heat generation.
 - Operating Temperature: -10°C to 50°C
 - Charging Temperature: 0°C to 40°C
 - Storage Temperature: -20°C to 60°C
- Should fluid from the battery pack accidentally get onto clothing or your skin, immediately rinse it off with clean tap water. Prolonged contact with battery pack fluid can cause skin irritation.
- Keep the battery pack out of the reach of small children. Do not let small children remove the battery pack from the charger unit or the unit it is powering.

■ **Optional Optical Communication Unit and Charger Unit**



- Keep the power cord away from stoves and other sources of extreme heat. Heat can melt the insulation of the power cord and create the danger of fire and electrical shock.
- Never pull on the power cord when unplugging it. Doing so can damage the cord and create the danger of personal injury, fire and electrical shock. Always hold onto the plug when unplugging it from the wall outlet.
- Never touch the plug while your hands are wet. Doing so can create the danger of electrical shock.



- Be sure to unplug the power cord from the wall outlet before moving the Optical Communication Unit and Charger Unit. Failure to do so can result in damage to the power cord caused by pulling it, which creates the danger of fire and electrical shock.
- Be sure to unplug the power cord from the wall outlet before cleaning the Optical Communication Unit and Charger Unit.
- Be sure to turn the power OFF and unplug the power cord after use.
- Unplug the power cord from the wall outlet whenever leaving the Optical Communication Unit and Charger Unit unattended for long periods.

- The contents of this manual are subject to change without notice.
- The term “Data Collector” as used in this User’s Guide refers to the CASIO DT-810 Data Collector unless otherwise noted.
- CASIO COMPUTER CO., LTD. assumes no responsibility for any loss or claims by third parties which may arise from the use of this manual.
- This manual does not cover programming or the uploading of data. See the separate manual for details of these procedures.



Contents

Safety Precautions	E-2
Unpacking	E-12
Introduction... ..	E-13
Handling Precautions	E-13
Data Collector Handling Precautions	E-13
DT-810 System Diagram	E-14
General Guide	E-15
Power Supply	E-16
Loading Alkaline Batteries	E-17
Installing the Lithium-ion Battery Pack	E-18
Installing the Back-up Battery	E-19
Attaching the Wrist Strap	E-22
Keys and Their Functions	E-23
Stroke Key Functions	E-23
Touch Panel Keys	E-24
Before Using the Data Collector for the First Time..	E-25
Aligning the Touch Panel Position	E-25
Using the Bar Code Reader	E-27
Performing a Bar Code Read Operation	E-27
Scan Position	E-28

Data Communication	E-29
DT-810-DT-810/800 Data Communication	E-29
DT-810-Computer Communication	E-29
Specifications	E-30
DT-823LI Lithium-ion Battery Pack Specifications	E-31
Using the Optional Optical Communication Unit	E-32
General Guide	E-32
Setting up the Optical Communication Unit and connect the Data Collector	E-34
Charging the Battery Pack	E-35
Setting the Optical Communication Unit	E-36
Connecting Two or More Optical Communication Units	E-38
DIP Switch Settings	E-39
DT-860IOE Optical Communication Unit Specifications	E-40
Using the High-Speed Charger Unit	E-41
General Guide	E-41
Charging a Battery Pack	E-41
DT-820CHGE High-Speed Charger Unit Specifications	E-43



CASIO ELECTRONICS CO., LTD.
Unit 6, 1000 North Circular Road
London NW2 7JD, U.K.

Unpacking

When unpacking the Data Collector, check carefully to make sure that all of the items shown below are included. If anything is missing or damaged, contact your original dealer or your nearest CASIO Service Provider.

- **Data Collector**



- **Back-up battery (lithium)**



- **Main batteries**
(Two AA (LR6)-size alkaline batteries)

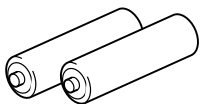

- **Wrist Strap**

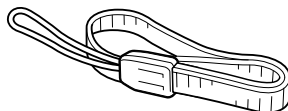

- **Touch panel stylus**

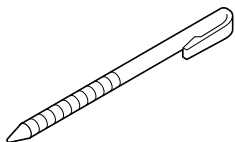

- **Battery compartment cover for lithium-ion battery pack**

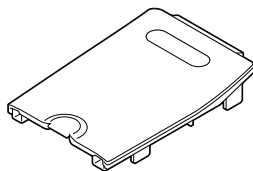

Introduction

Make sure you carefully read the following information to ensure that your Data Collector is able to perform at the level for which it is designed.

Handling Precautions

- Never try to take the unit apart or modify it in any way.
- Avoid leaving the Data Collector in direct sunlight, near heaters, or in any other area where it might be subjected to intense heat for long periods. Also avoid areas subjected to high humidity and large amounts of dust. Do not leave the Data Collector in a closed motor vehicle.
- Do not throw or drop the Data Collector or otherwise subject it to strong impact, which can damage the LCD screen, interrupt program execution, corrupt memory contents, or otherwise interfere with proper operation.
- Use only your finger or a blunt object to operate the stroke keys, and your fingers or the supplied stylus to operate the touch panel. Use of a sharp pointed object can damage stroke keys and the touch panel, and cause shorting of internal circuitry.
- Use a soft, dry cloth when cleaning the Data Collector. Do not wipe with a wet cloth. Do not use benzene, thinner, or other volatile chemicals, which can result in deformation and deterioration of the materials used in the keys and case.
- Never place any objects on top of the Data Collector.
- Do not lay the Data Collector down with its key panel downwards. Doing so runs the risk of accidental key operation, which can cause malfunction.

Data Collector Handling Precautions

- Never remove the main batteries while Data Collector power is turned on. Doing so will cause all data in memory to be lost.
- Sudden temperature changes can cause condensation to form on the Data Collector's case. Operating the Data Collector while condensation is present can interfere with proper operation. Take care to avoid conditions that cause the formation of condensation. If condensation does form, wait until it dries completely before using the Data Collector.

DT-810 System Diagram



M60E/M70E

Options

Optical Communication Unit

DT-860IOE

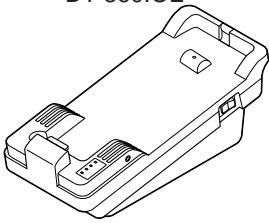

High-speed Charger Unit

DT-820CHGE

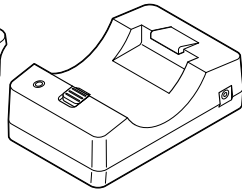

Lithium-Ion Battery Pack

DT-823LI

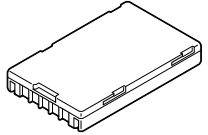

Cables

DT-881RSC
DT-882RSC
DT-883RSC

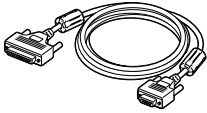

SB-703

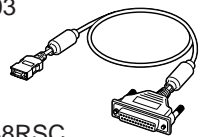

DT-884RSC
DT-885RSC

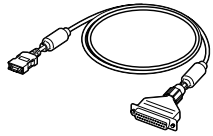

DT-888RSC

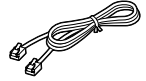

DT-887AX

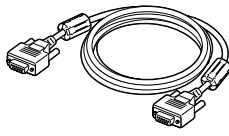

DT-889AX

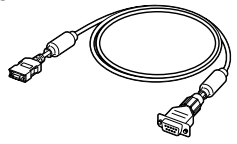

AC Adaptor

For High-Speed Charger Unit

For Optical Communication Unit

DT-9020ADP-G

DT-9020ADP-U

DT-825ADP-G

DT-825ADP-U

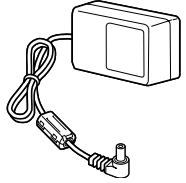
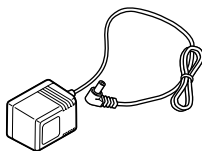

General Guide

• Left side

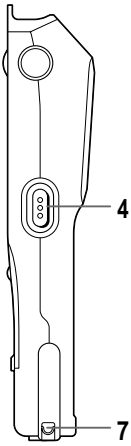

• Front

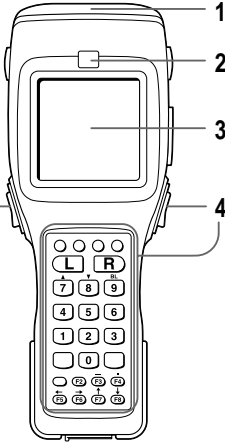

• Right side

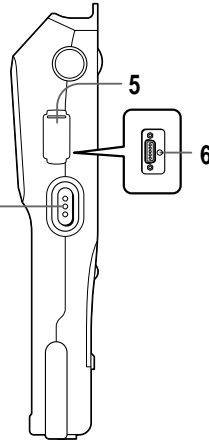

• Back

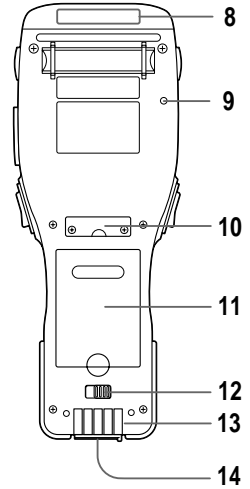

• Bottom

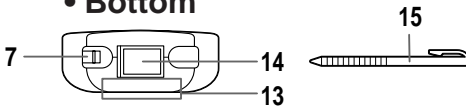

1	Reader port	Emits a laser for bar code reading.
2	Read indicator	Indicates the status of the read operation: green for a successful read, red when the read is no good.
3	LCD screen and touch panel	Displays various data when a program is being run (LCD screen). Areas on the screen can be touched with the finger or supplied stylus to perform various key operations (touch panel). Pressing a key inputs the alpha character or punctuation marked on it.
4	Stroke keys	A total of 28 keys are provided to turn power on and off, to trigger bar code reading, and for other operations.
5	RS-232C connector (inside cap)	Allows connection of other devices for system expansion.
6	Reset button (inside cap)	Use a paper clip or other thin object to press the RESET button located inside the hole.
7	Wrist strap hook	Hook for installing the wrist strap.
8	Laser warning label	Class 1 laser warning label.
9	Speaker	Outputs operation confirmation tones. Take care to avoid blocking the speaker holes and reducing output sound volume. Never insert any thin, pointed object into the speaker holes. Doing so can cause malfunction.
10	Back-up battery compartment	Holds memory backup lithium battery.
11	Main battery compartment	Holds main batteries.
12	Main battery compartment lock	Locks main battery compartment cover in place. Data Collector power does not turn on if the battery compartment cover lock is not in the LOCK position.
13	Charger/AC terminal	This terminal receives power when the Data Collector is attached to an optional Optical Communication Unit.
14	Infrared port	This port is for contact-less infrared data communication with another DT-810/DT-800 unit or an optional Optical Communication Unit.
15	Touch panel stylus	Use this stylus for touch panel key input.

Power Supply

The Data Collector has both a main power supply (two AA (LR6)-size alkaline batteries or a lithium-ion battery pack) and a backup power supply (lithium battery). In this manual, the words “main batteries” refer to both alkaline batteries and the lithium-ion battery pack.

Low main battery power is indicated when the low voltage message appears on the LCD screen. Replace the main batteries or charge the battery pack as soon as possible after the low voltage message appears.

- Important!**
- **Never remove both the main batteries and backup battery at the same time. Doing so causes all programs and data in Data Collector memory to be lost.**
 - **Never remove the main batteries from the Data Collector while power is turned on. Doing so can cause data stored in memory to be deleted. Be sure to turn the Data Collector off before removing batteries.**
 - **Use only AA (LR6)-size alkaline batteries or the specified lithium-ion battery pack specified for the DT-810.**
 - **The lithium-ion battery pack discharges naturally during the time it takes for it to get from the factory to you. Make sure to charge the battery pack before using it for the first time.**
 - **Never allow the terminals of the lithium-ion battery to become shorted. Doing so creates the danger of malfunction. Be sure to keep the battery pack in its special case when transporting or storing it.**
 - **Repeat charging of the lithium-ion battery pack gradually shortens its ability to recharge. If you find that a fully charged battery pack provides only little operation time, it probably means you need a new battery pack.**
 - **Whenever you do not plan to use the Data Collector for a long time, load two new alkaline batteries or a fully charged battery pack into the Data Collector to protect against power failure during non-use. Also, load new batteries or a fully charged battery pack before using the Data Collector after a long period of non-use.**

Loading Alkaline Batteries

- 1 Slide the main battery compartment cover lock to the FREE position and remove the cover.

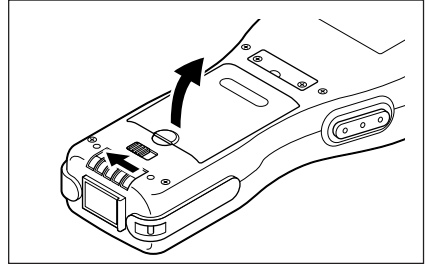

- 2 Install two new AA (LR6)-size alkaline batteries onto the battery compartment cover, making sure their positive (+) and negative (-) ends are facing correctly.

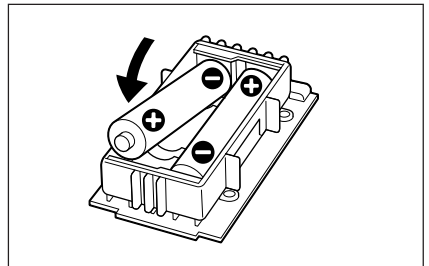

- 3 Attach the battery compartment cover to the Data Collector and slide the main battery compartment cover lock to the LOCK position.

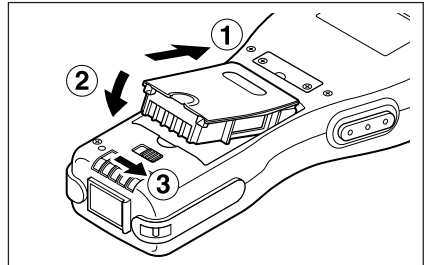

To remove alkaline batteries

- 1 Slide the main battery compartment cover lock to the FREE position and remove the cover.

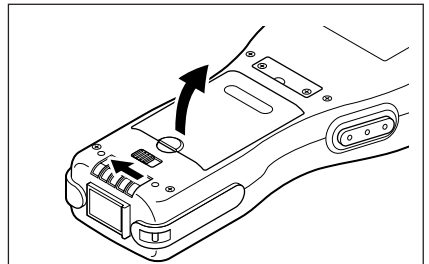

- 2 Remove the alkaline batteries from the battery compartment cover.

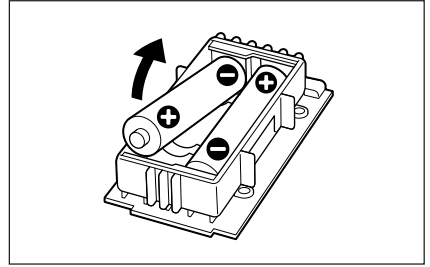

Installing the Lithium-ion Battery Pack

- 1 Slide the main battery compartment cover lock to the FREE position and remove the cover.

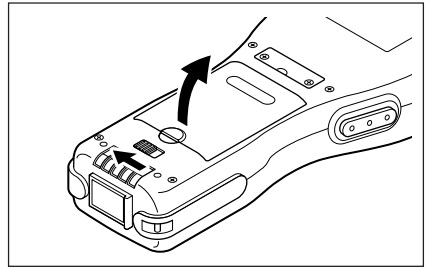

- 2 Taking care to correctly orient the terminals of the battery pack, align the tab on the back of the supplied lithium-ion battery pack battery compartment cover with the groove of the battery pack, and slide the battery pack onto the cover.

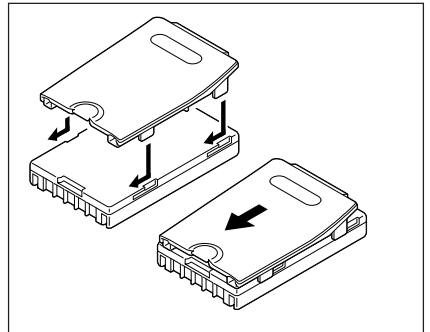

- 3 Attach the battery compartment cover to the Data Collector and slide the main battery compartment cover lock to the LOCK position.

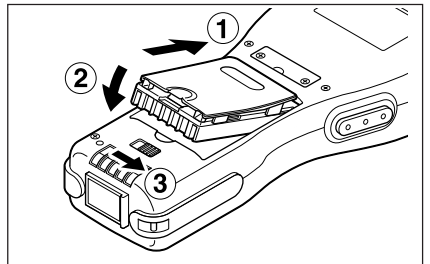

To remove the lithium-ion battery pack

- 1 Slide the main battery compartment cover lock to the FREE position and remove the cover.

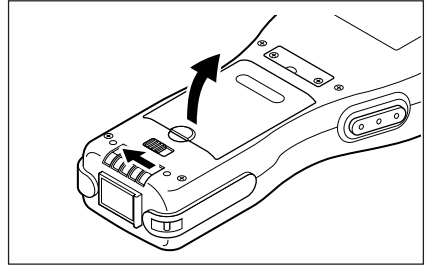

- 2 Slide the lithium-ion battery pack from the battery compartment cover.

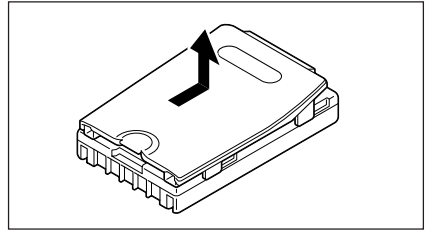

Installing the Back-up Battery

- 1 Use a screwdriver to rotate the screw that secures the backup battery holder in place counterclockwise to loosen it.

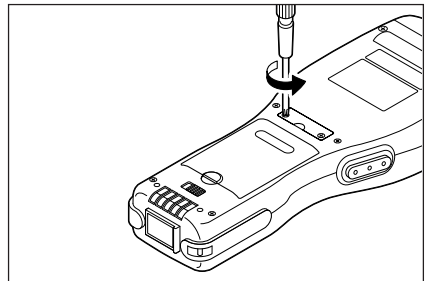

- 2 Insert a screwdriver or some flat object into the back of the backup battery holder and pull out it.

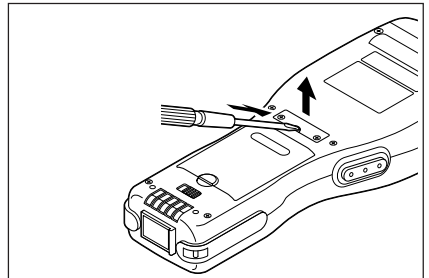

- 3** Pull out the backup battery holder.

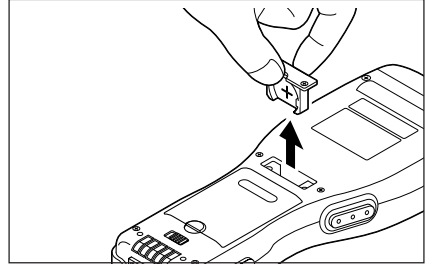

- 4** Wipe off a CR2032 lithium battery with a dry cloth, and load it into the backup battery case so its plus (+) side is facing towards the holder (so you can't see it).

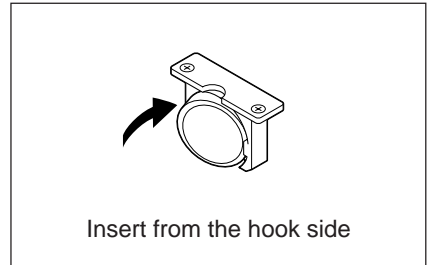

- 5** Load the battery holder into the Data Collector and tighten the screw.

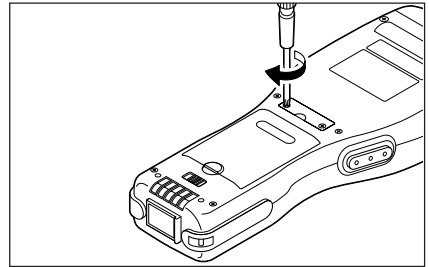

To replace the Back-up Battery

Replace the backup battery as soon as possible after the low voltage message appears on the display. Always make sure that power is turned off when replacing the backup battery, and use only a CR2032 lithium battery.

- Important!**
- **Removing the lithium backup battery while the main batteries are removed or while main battery power is low can cause data stored in memory to become corrupted.**
 - **Always double check to make sure the positive (+) side of the backup battery is facing correctly.**

- 1** Use a screwdriver to rotate the screw that secures the backup battery holder in place counterclockwise to loosen it.

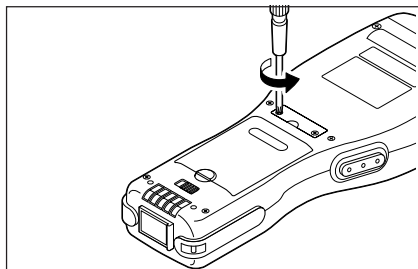

- 2** Insert a screwdriver or some flat object into the back of the backup battery holder and pull out it.

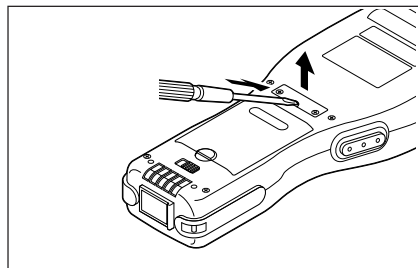

- 3** Pull out the backup battery holder.

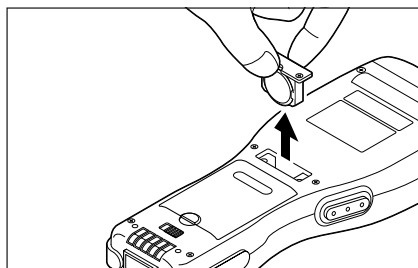

- 4** Remove the old backup battery. Wipe off a new CR2032 lithium battery with a dry cloth, and load it into the backup battery case so its plus (+) side is facing towards the holder (so you can't see it).

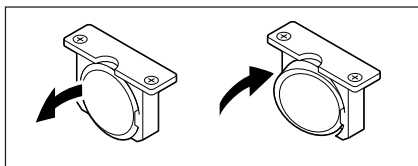

- 5** Load the battery holder into the Data Collector and tighten the screw.

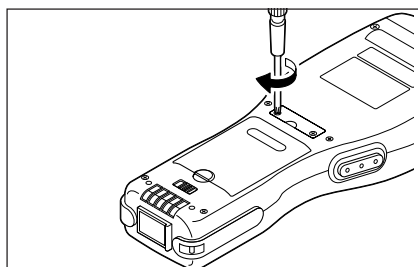

■ Attaching the Wrist Strap

The wrist strap protects the Data Collector against being damaged by dropping during transport.

To attach the wrist strap

- 1 Pass the wrist strap through the metal wrist strap bar on the bottom of the data collector.

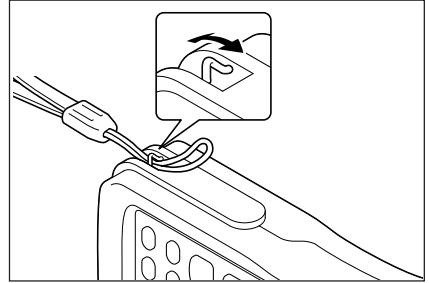

- 2 Double the strap back through its own loop, and pull it tight.

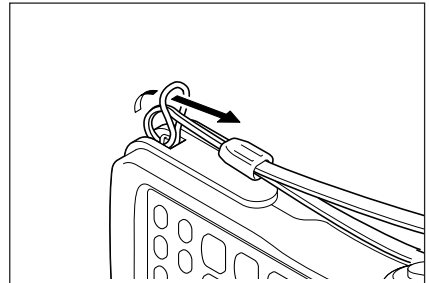

Important! • Never swing the Data Collector around by its wrist strap.

Keys and Their Functions

Operations are controlled by 28 stroke keys and touch panel keys.

Stroke Key Functions

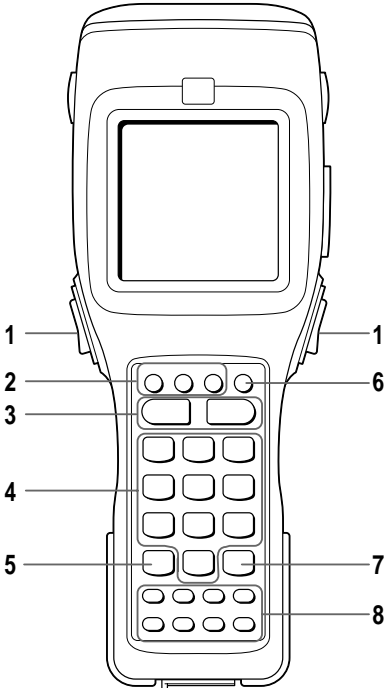

1 Trigger key

Triggers a bar code read operation. Any other function can also be assigned to this key.

2 Control keys

FNC key: Switches between the Function Mode and Normal Mode.

BS key: Backspaces and deletes one character.

LOCK key: Enables and disables user-defined keys.

3 Multi-function (L/R) keys

Keys that can be assigned any function.

4 10-key pad

The function of these keys depends on whether the Data Collector is in the Normal Mode or Function Mode.

Normal Mode: Numeric input

Function Mode:

0 to 6: Executes function assigned to each key.

7: Increases display contrast.

8: Decreases display contrast.

9: Turns display backlight on and off.

5 Clear key Clears previous key input.

6 Power key Turns power on and off.

7 Enter key Registers input.

8 Function keys

Keys that can be assigned any function except for the trigger key function. The following are the initial functions assigned to these keys.

F1 (Alpha): Displays a keypad of alpha characters and punctuation (during key input standby only).

F2 (SP): Inputs a space.

F3 (-): Inputs a minus (-) sign.

F4 (.): Inputs a period.

F5 (←): Moves the cursor left.

F6 (→): Moves the cursor right.

F7 (↑): Moves the cursor up.

F8 (↓): Moves the cursor down.

Touch Panel Keys

The touch panel on the LCD screen of the Data Collector can be operated with your finger or the supplied stylus to input data. Use of the stylus is recommended whenever you have problems operating the touch panel with your finger.

Inputting alpha characters and punctuation

Pressing the F1 (Alpha) key while the Data Collector is standing by for input enters the Alpha Mode and displays an alpha character touch panel screen.

A	B	C	D	E
F	G	H	I	J
K	L	M	N	O
P	Q	R	S	T
U	V	W	X	Y
Z	*	/	+	-

Switching Between Alpha Mode Touch Panel Screens

Pressing the Multi-function (L/R) keys while in the Alpha Mode changes the touch panel screen as shown below.

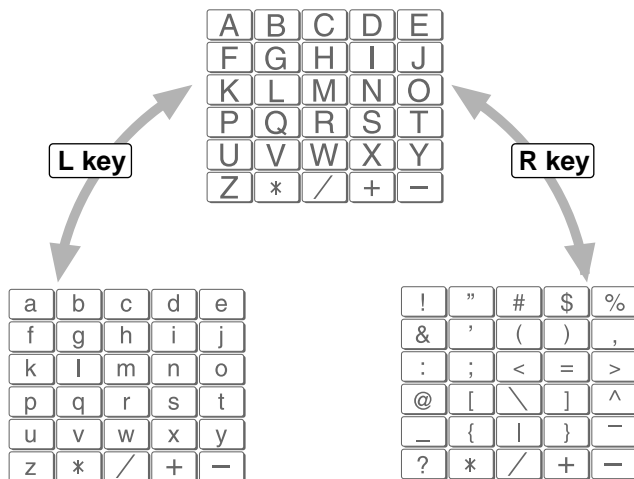

Touch Panel Alignment

Perform touch panel alignment whenever you find that the position of the touch panel keys is not aligned with the area of the LCD screen that must be pressed to perform the function of the keys.

Important! • Should a message appear alerting you to a touch panel abnormality, take the Data Collector to your original dealer or an authorized CASIO service provider for maintenance.

■ Before Using the Data Collector for the First Time ■

Be sure to perform the reset operation described below before using the Data Collector for the first time after you purchase it.

Make sure Data Collector power is turned off.



Use a paper clip or some other thin object to press the RESET button.



Perform touch panel alignment.



Perform a RAM drive check. If the drive is not formatted, display the check screen and format it.

The system menu starts up.

Important! • The above procedure needs to be performed only before you use the Data Collector for the first time after purchasing it, or after memory contents are deleted due to main batteries and the backup battery going dead or being removed at the same time. If the RESET button is pressed accidentally, you must complete the other steps of the above procedure to reset the Data Collector.

Aligning the Touch Panel Position

Always correctly align the touch panel position.

Failure to do this may cause problems. For instance ...

— the display might not match the position you touched

— the display might not show the same characters you entered

So set correctly and promptly realign the touch panel if position errors occur.

HOW TO ALIGN THE TOUCH PANEL

- 1** Finish any on-going job and turn off the power.
- 2** Display the SYSTEM MENU as follows.
Press **PW** while holding down **FNC** and **0** to start up the SYSTEM MENU.
- 3** Press **5** to select the touch panel CALIBRATION menu.

SYSTEM MENU

1 : EXECUTE AP

2 : SET MODE

3 : DATE / TIME

4 : TRANSMIT

5 : CALIBRATION

6 : VERSION

- 4** Make the touch panel alignment.
Using the stylus (pen) supplied with the unit, touch the centers of the 4 plus (+) marks in the order shown by the arrows.

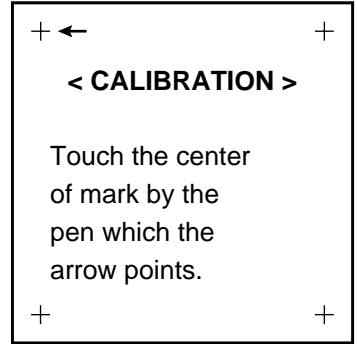
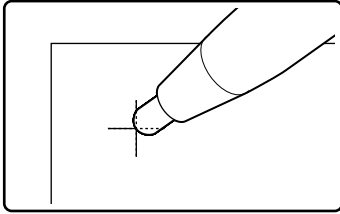

- 5** Press **2** on the menu to end the touch panel alignment.

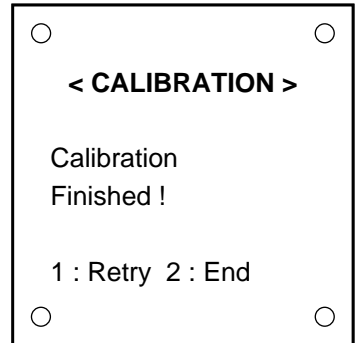

- 6** Press **1** to quit the SYSTEM MENU.

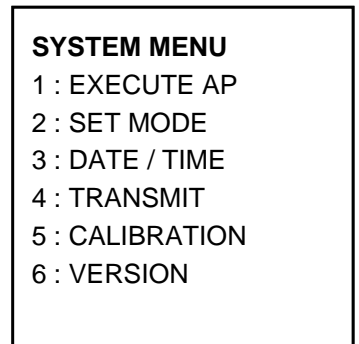

Using the Bar Code Reader

Performing a Bar Code Read Operation

- 1 Turn on the Data Collector, position the reader port close to the bar code you want to read, and then press the trigger key.

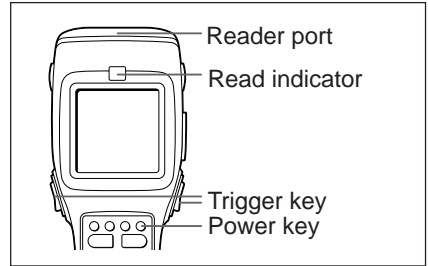

- 2 The reader port emits a laser to read the bar code. The read indicator lights green when the read is successful.

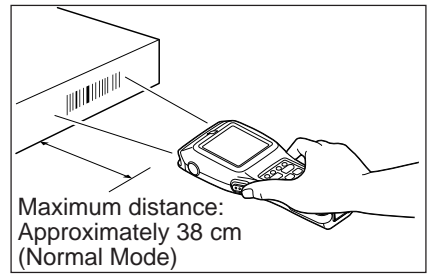

- Important!**
- If you have problems with the read operation, change the angle between the label and Data Collector, or move closer and then try again.
 - If the bar code is larger than the diameter of the Data Collector's reader port, try moving the Data Collector a bit farther away from the bar code.
 - The Data Collector should be able to read a bar code from the maximum distance of 38 centimeters under the following conditions.

Ambient Light: 500 lux (fluorescent)

PCS: 0.9 min.

Minimum Bar Width: 1.2 mm

ITF (extended version)



EXPLANATORY LABEL

- Wavelength: 670 nm
Maximum output: 1.0 mW
- CAUTION
Use of controls or adjustments or performance of procedures other than those specified herein may result in hazardous radiation exposure.

Scan Position

When reading a small bar code, decrease the distance between the Data Collector and the bar code. For larger bar codes, position the Data Collector so that the bar code fits into the laser beam.

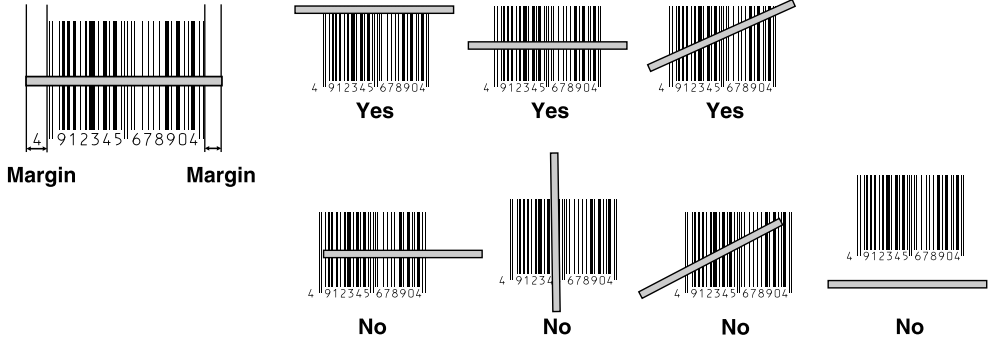

Important! • Never look directly into the laser beam emitter or point the laser beam directly into someone's eyes.

Sample Bar Codes

EAN (Standard)

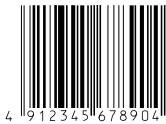

EAN (Abbreviated)



NW-7



CODE39



UPC



CODE93

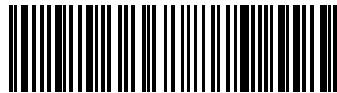

Data Communication

DT-810 - DT-810/800 Data Communication

Application software and input data can be transferred between two DT-810 units using the infrared ports on the bottom of the units.

Position the two DT-810 units so they will not accidentally move during data communication. The orientation of the two units depends on the type of communication you plan to perform.

- Conformed IrDA Version 1.0:
0 (contact) to 1 meter or less enables communication
- Original Communication:
Enabled by contact only

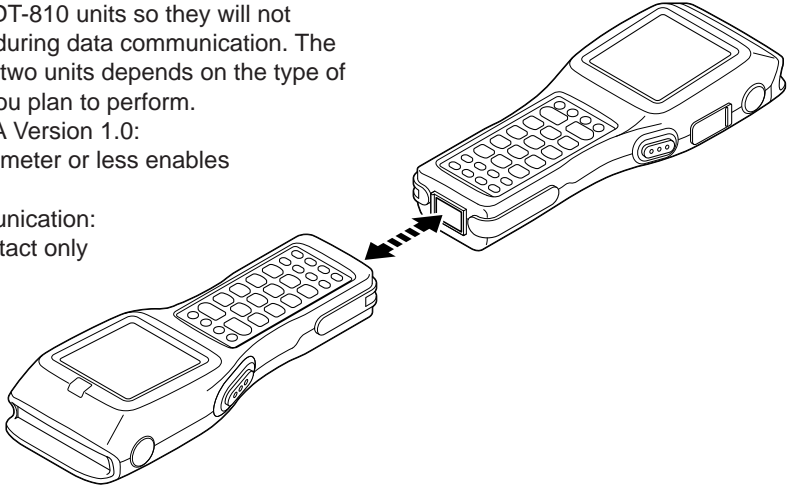

DT-810 - Computer Communication

Data can be transferred directly between the Data Collector and a personal computer by using a cable to connect the RS-232C connector on the right side of the Data Collector to the computer's RS-232C connector.

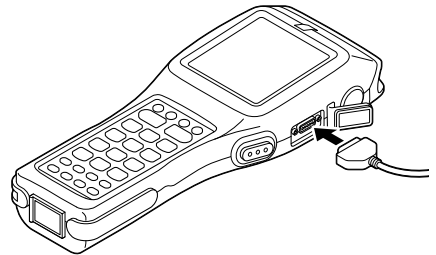

CAUTION! For IrDA transmission function, high sensitivity element is used in this unit.

Avoid the proximity of a unit or equipment such as a cellular phone emitting electrical current during data communication.

To get a smooth transfer using this unit, keep some distance from the equipment (at least 30 centimeters from a cellular phone).

Specifications

• General

CPU:	32-bit RISC Type
RAM:	M60E: 6MB (2MB RAM + 4MB Flash ROM)
	M70E: 10MB (2MB RAM + 8MB Flash ROM)

• Display

Type:	STN LCD with phase correction film
Capacity:	160 x 160 dots
Display contrast:	Manually adjustable; includes automatic temperature compensation
Backlight:	EL backlight

• Laser Scanner

Readable Codes:	EAN, JAN, UPC, NW-7, CODE39, ITF, CODE93, CODE128, MSI, Industrial 2 of 5
Maximum Non-contact Distance:	Approximately 38cm (Normal Mode), Approximately 25cm (High-resolution Mode)

• Input

Touch Panel Keys:	Analog touch panel
Stroke Keys:	28

• Infrared Communications

Interface:	Infrared (contact-less)
Standards:	Conformed IrDA Ver. 1.0, Original
Control Protocol:	Half-duplex
Synchronization:	Asynchronous
Speed:	2,400 to 230,400 bps
Communication Distance:	Conformed IrDA Version 1.0: 0 (contact) to 1 meter or less Original Communication: Contact

• 10-pin Serial Communications

Interface:	RS-232C
Control Protocol:	Full-duplex
Synchronization:	Asynchronous
Speed:	1,200 to 115,200 bps

- **Power Supply**

Main: Two AA (LR6)-size alkaline dry cell batteries or one lithium-ion battery pack
Alkaline Battery life:
Approximately 80 hours (using a new set of batteries at normal temperature, two read operations every 10 seconds)
Lithium-ion Battery Pack life:
Approximately 40 hours (using a new, fully charged battery pack at normal temperature, two read operations every 10 seconds)

Backup: One CR2032 lithium battery
Battery life: Approximately two weeks (when only the backup battery is supplying backup power)

- **Size and Weight**

Dimensions: Approximately 55 <81> (W) x 220.8 (D) x 29.5 <44> (H) mm
Values in <square brackets> are display dimensions. Protrusions not included.

Weight: M60E/M70E: Approximately 310g

DT-823LI Lithium-ion Battery Pack Specifications

Power Supply: Rated Capacitance: 820mAh
Rated Voltage: 3.6 V
Dimensions: Approximately 64 (W) x 40 (D) x 11(H) mm
Weight: Approximately 55 g
Accessories: Soft case

Using the Optional Optical Communication Unit

The optional Optical Communication Unit (DT-860IOE) makes it possible to upload and download system data and file data between the Data Collector and a personal computer. It is also used to supply power for charging the lithium-ion battery pack.

Be sure to use the specified RS-232C cable (DT-881RSC/DT-882RSC/DT-883RSC/DT-887AX) to connect the Optical Communication Unit to a personal computer.

The Optical Communication Unit can be located on a desk or table top, or mounted on a wall. For wall mounting, be sure to use the supplied wall mount unit.

General Guide

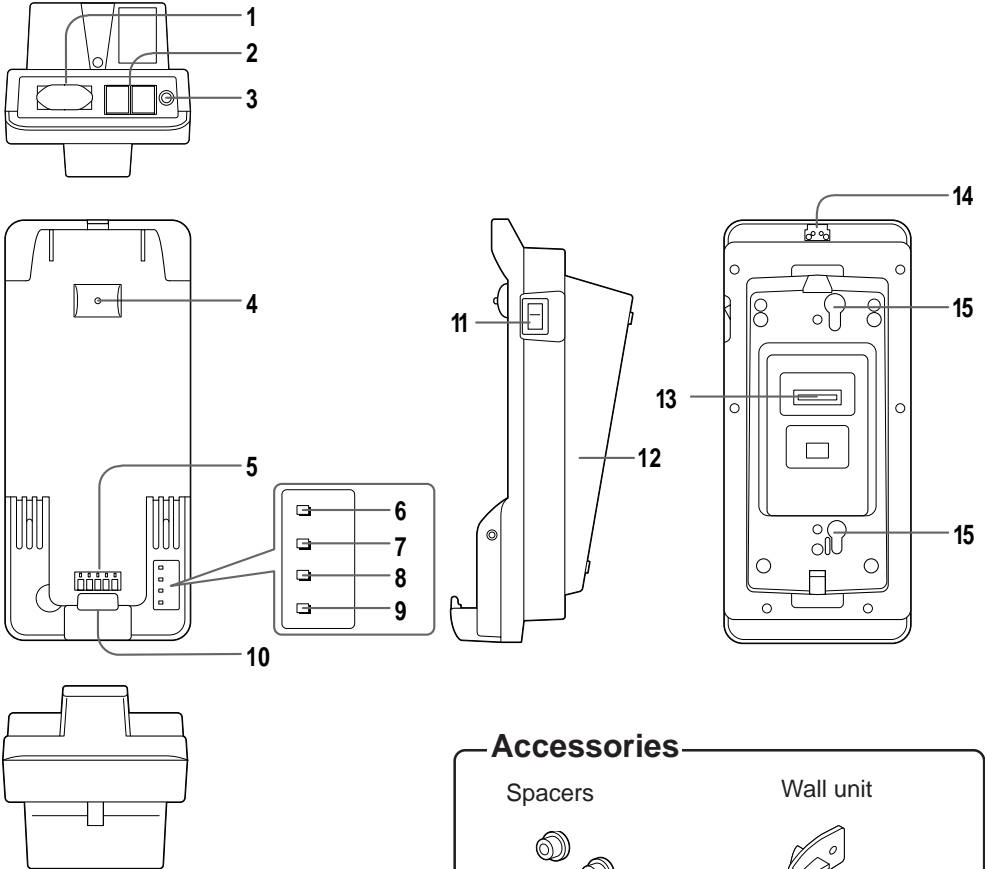

Accessories

Spacers



Wall unit

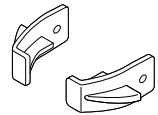

Wood screws



Wall unit screws



1	RS-232C connector	For connection of a PC and uploading/downloading of system data and file data.
2	RS-422 connectors	For connection of multiple optional Optical Communication Units.
3	AC adaptor jack	For connection of an AC adaptor to supply power.
4	Data Collector detection switch	Detects whether or not the Data Collector is mounted correctly on the Optical Communication Unit.
5	Charge/Power supply terminal	Supplies power to the Data Collector mounted on the Optical Communication Unit.
6	System operation indicator	Indicates whether or not the system operation is normal. A system operation problem is indicated when this indicator does not light up green shortly after the Data Collector is mounted onto the Optical Communication Unit. Off: All Data Collectors mounted on the Optical Communication Units are unable to communicate, or there is a system problem. Lit Green: Normal system operation. One or more of the Data Collectors mounted on the Optical Communication Units are communicating.
7	Data communication indicator	Indicates the status of data communication operations. Off: Not communicating Flashing Green: Communication in progress Lit Red: Optical Communication Unit connection problem
8	Charge indicator	Indicates the charge status of the lithium-ion battery pack. Off: Not charging (Data Collector battery compartment contains alkaline batteries) Lit Red: Charging Lit Green: Charging complete Flashing Red: Battery pack problem Flashing Green: Charging interrupted because ambient temperature is outside of allowable range for charging. Charging will resume when temperature is back within the allowable range.
9	Power indicator	Indicate whether power is on or off, and if the Data Collector is mounted. Off: Power off Red: Power on, Data Collector not mounted Green: Power on, Data Collector mounted
10	Infrared port	This port provides contact-less infrared communication capabilities with a Data Collector.
11	Power switch	Turns power on and off.
12	Base	Reverse the position of the base when wall mounting the Optical Communication Unit.
13	DIP switches	Use these switches to set the operational configuration of the Optical Communication Unit.
14	Wall mounting tab	Secures the Data Collector when mounting it on a wall.
15	Wall mounting hole	Use this hole to attach the Optical Communication Unit to a hook on a wall.

Setting up the Optical Communication Unit and connect the Data Collector

Use only the specified AC Adaptor for Optical Communication Unit to connect to an electrical outlet. Be sure to connect the AC adaptor and turn on Optical Communication Unit power before performing any data communication operation with the Data Collector. Power is supplied to the Data Collector by the Optical Communication Unit.

- 1 Plug the AC adaptor into an electrical outlet.
- 2 After making sure that the power switch of the Optical Communication Unit is in the OFF position, plug the other end of the AC adaptor into the AC terminal at the top of the Optical Communication Unit.
- 3 After making sure that the power of the Optical Communication Unit and personal computer is off, remove the cover and connect one end of the optional RS-232C cable (DT-881RSC, DT-882RSC, DT-883RSC, DT-887AX) to the RS-232C connector at the top of the Optical Communication Unit. Connect the other end of the cable to the computer's RS-232C connector. When the RS-232C connector is not used, attach the cover.

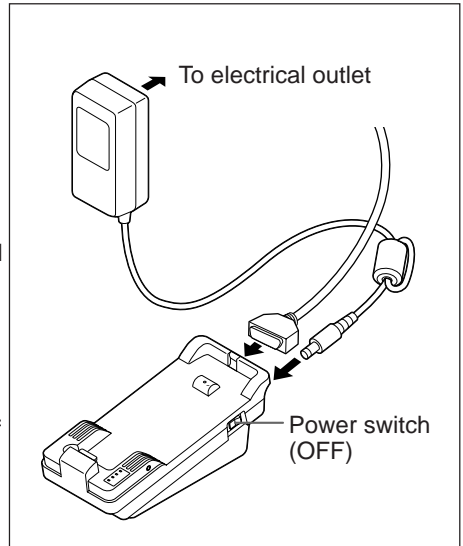

- 4 Turn on the Optical Communication Unit power, which causes the power indicator to light up red.
- 5 Attach the Data Collector to the Optical Communication Unit, making sure their infrared ports come into close contact with each other. The color of the Optical Communication Unit power indicator changes to green when proper connection is achieved.
 - The system operation indicator light up green when system operation is normal and the Optical Communication is performing or standing by for data communication with another Data Collector connected to an Optical Communication Unit.
 - The data communication indicator flashes green when a data communication operation starts.

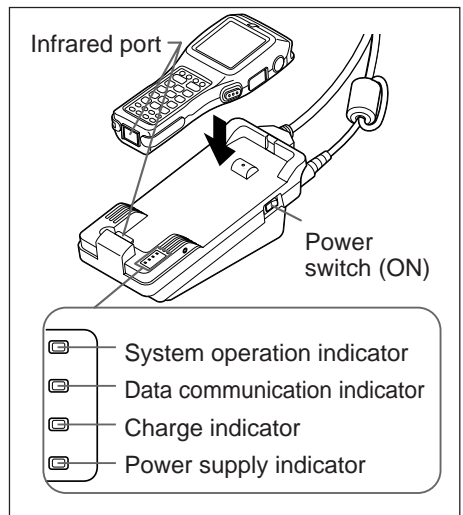

Charging the Battery Pack

The following procedure can be used only when a lithium-ion battery pack is loaded in the Data Collector.

- 1 Turn on the power of the Optical Communication Unit, and confirm that its power indicator lights up red.
- 2 Attach the Data Collector to the Optical Communication Unit, making sure their infrared ports come into close contact with each other. The color of the Optical Communication Unit power indicator changes to green when proper connection is achieved. The charge indicator lights up red when charging starts.

Charge Indicator

Red: Charging

Green: Charging complete

Flashing Red: Defective battery pack

Flashing Green: Temperature outside of allowable charging range (Charging will resume with a return to normal temperature.)

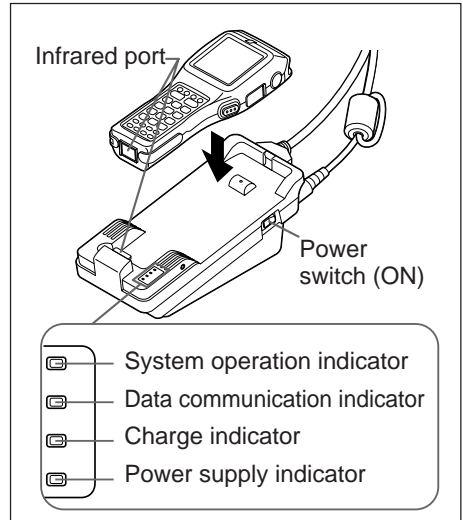

- Important!**
- If the charge indicator starts to flash red during charging, remove the battery pack and then reattach it. If this does not solve the problem, it means that the battery pack is defective and needs to be replaced.
 - Use only the specified battery pack.
 - Battery packs naturally discharge even when they are not loaded in the Data Collector. Use a battery pack as soon as possible after charging it.
 - The allowable battery pack charging temperature range is 0°C to 40°C. Outside this range, charging can result in battery fluid leakage and generation of heat. It can also cause deterioration of battery pack performance and shorten battery pack life.
 - For best charging results, keep the Optical Communication Unit, Data Collector and battery pack contacts clean by periodically wiping them off with a cotton swab or dry cloth.

Setting the Optical Communication Unit

You can hang the Optical Communication Unit on a wall or use it as a desktop unit.

To use the Optical Communication Unit on a desktop

Simply place the Optical Communication Unit on a desk, table, or any other flat, stable surface, rubber feet down. You can even use the wood screws to anchor the base onto a horizontal surface. If you do not anchor the base, make sure you locate the Optical Communication Unit where there is no danger of it falling.

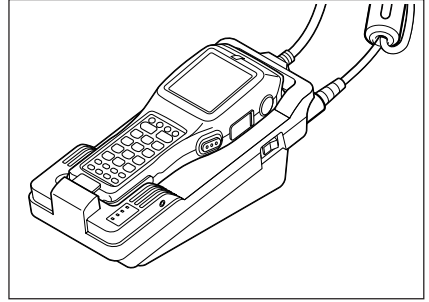

To hang the Optical Communication Unit on a wall

1 Insert the wall mount unit into the Optical Communication unit and secure it in place with the two screws.

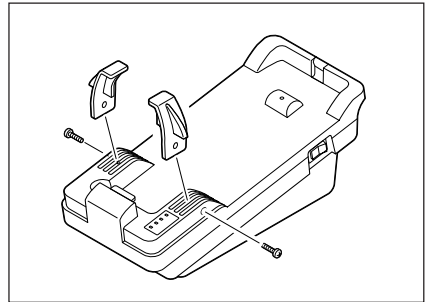

2 Remove the two screws that secure the base of the Optical Communication Unit in place.

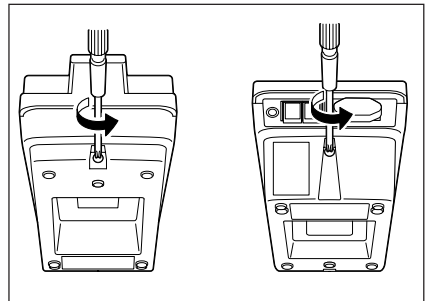

3 Move the tab on the upper side of the Optical Communication Unit.

- ① Remove the two screws on the back that secure the tab.
- ② Press the tab down to the plate.
- ③ Reattach the two screws removed in step ① to the holes on the upper side.

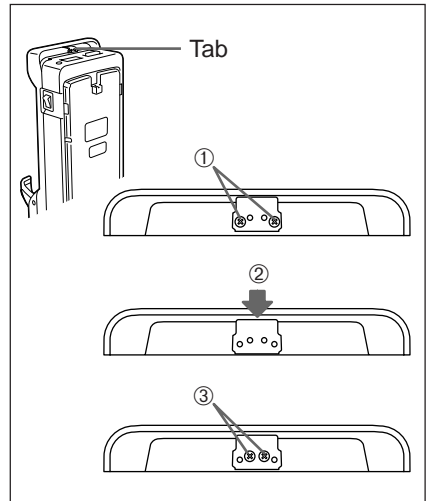

4 Pressing in at the four corners of the Optical Communication Unit base, unhook the tabs and remove the base from the unit.

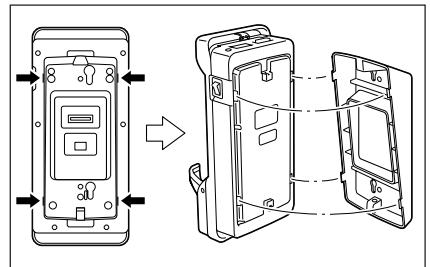

5 Position the base on the wall where you want to hang the Optical Communication Unit, and use an awl or some other sharp object to mark the positions of the two wood screws.

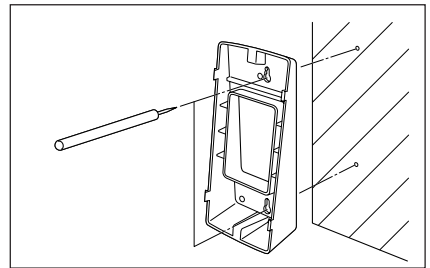

6 Slip a spacer over each of the wood screws and then drive the screws into the wall at the positions you marked in the previous step. Make sure that the spacers are oriented correctly. You will not be able to hook the Optical Communication Unit onto the screws if the spacers are backwards.

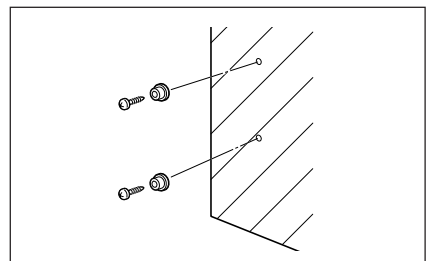

- 7** Reattach the base to the Optical Communication Unit, orienting it upside-down from what it was when you removed it, and secure it in place with the two screws.

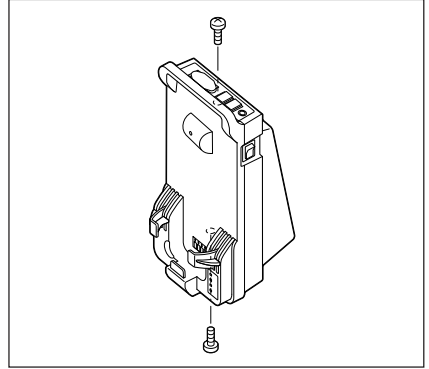

- 8** Hook the Optical Communication Unit onto the screws in the wall, and let it slide down to lock in place.

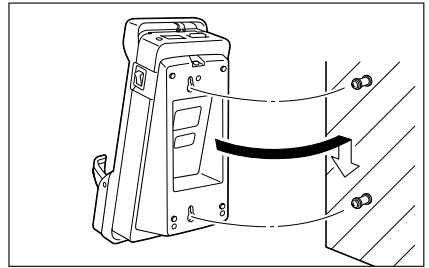

- Important!**
- Be sure to check the wood screws periodically for looseness and tighten when necessary after hanging the Optical Communication Unit on a wall.

Connecting Two or More Optical Communication Units

Up to 7 Optical Communication Units can be connected together using optional 6-6-pin modular cable (DT-888RSC). This configuration makes it possible to upload and download data between multiple Data Collector units and a personal computer at the same time.

Configuration

Connect the C-OUT terminal of the Optical Communication Unit that is closer to the host computer to the C-IN terminal of the next unit.

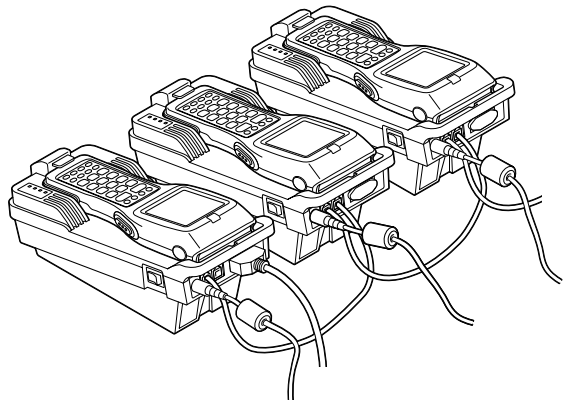

DIP Switch Settings

The settings of the DIP switches located on the bottom of the Optical Communication Unit can be adjusted to achieve the desired hardware configuration.

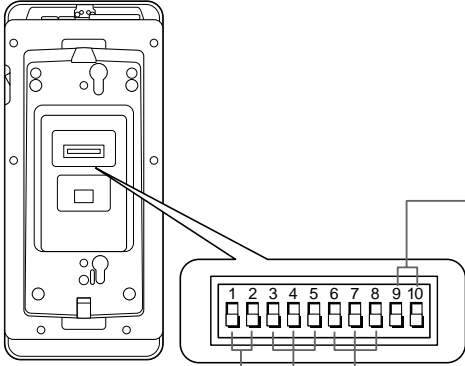

Flow Control

	9	10
Off	OFF	OFF
X ON/X OFF	ON	OFF
RS/CS	OFF	ON
Use Special Software	ON	ON

Optical Communication Unit - Host Computer Communication speed

	6	7	8
2,400bps	OFF	OFF	OFF
4,800bps	ON	OFF	OFF
9,600bps	OFF	ON	OFF
19,200bps	ON	ON	OFF
38,400bps	OFF	OFF	ON
57,600bps	ON	OFF	ON
115,200bps	OFF	ON	ON

* Communication speed can be set by Data Collector overrides this setting.

Connection Type

	3	4	5
Host Computer Connection	OFF	OFF	ON (No linking) OFF (Linking)
Intermediate Unit in Linked Chain	ON	OFF	OFF
Terminator Unit in Linked Chain	ON	OFF	ON

Data Collector - Optical Communication Unit Communication Speed

	1	2
38,400bps	OFF	OFF
115,200bps	ON	OFF
230,400bps	OFF	ON

Important! • Other settings not shown here are used for special-purpose modes, and should not be used.

DT-860IOE Optical Communication Unit Specifications

Infrared

Interface:	Infrared
Standard:	Conformed IrDA Ver. 1.0 Original
Synchronization:	Asynchronous
Speed:	9,600/38,400/115,200/230,400bps

RS-232C

Synchronization:	Asynchronous
Speed:	2,400 to 115,200bps
Control Protocol:	Full-duplex

RS-422

Synchronization:	Asynchronous
Speed:	9,600/38,400/115,200/230,400bps

Charger

Charger Type:	Fixed voltage (with current limiter)
Charge Time:	Approximately 2.5 hours

Power Supply

Method:	Special AC adaptor
Current Consumption:	Approximately 600mA (when charging)

Functions

Infrared interface
RS-232C interface
RS-422 interface

Dimensions and Weight

Desktop Dimensions:	Approximately 110 (W) x 250 (D) x 95 (H)mm
Weight:	Approximately 475 g
Wall Mounted Dimensions:	Approximately 110 (W) x 115 (D) x 250 (H)mm
Weight:	Approximately 480 g

■ Using the High-Speed Charger Unit

The optional DT-820CHGE High-Speed Charger Unit provides high-speed charging of a lithium-ion battery pack (which is not loaded in the Data Collector).

General Guide

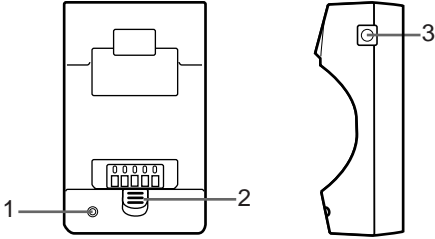

1 Charge indicator	Indicates the charge status of the lithium-ion battery pack. Off: Not charging Red: Charging Flashing Red: Defective battery pack Green: Charging complete Flashing Green: Temperature outside of allowable charging range (Charging will resume with a return to normal temperature).
2 Release lever	Pull the release lever forward when removing the battery pack from the High-Speed Charger Unit.
3 AC terminal	For connection of the AC adaptor.

Charging a Battery Pack

1 Plug the AC adaptor into an electrical outlet.

2 Plug the AC adaptor cord into the AC connector on the side of the High-Speed Charger Unit.

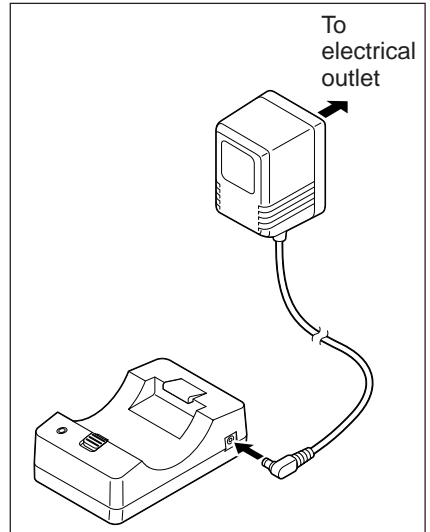

- 3** Insert the lithium-ion battery pack you want to charge into the High-Speed Charger Unit with its terminals facing down.

This causes the CHARGE indicator to light red to indicate that charging has started.

The following shows how the charge indicator shows the status of the charge.

Lit Red: Charging

Lit Green: Charge complete

Flashing Red: Battery pack problem

Flashing green: Charging interrupted because ambient temperature is outside of allowable range for charging. Charging will resume when temperature is back within the allowable range.

It takes about 2.5 hours to attain a full charge.

- 4** After the charging operation is complete (indicated when the CHARGE indicator lights green), slide the release lever forward and remove the battery pack from the High-Speed Charger Unit.

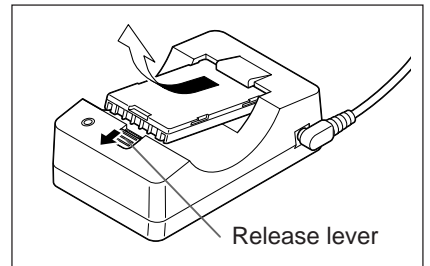
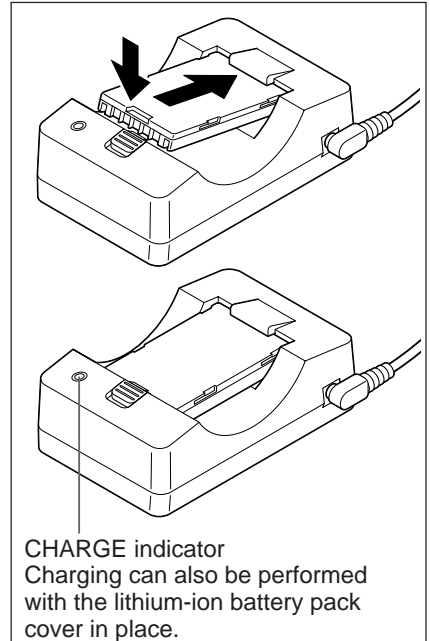

- Important!**
- Never allow the AC adaptor cord to bend too sharply. Doing so can result in a broken electrical connection.
 - If the CHARGE indicator flashes red during charging, remove the battery pack and re-insert it. If the red flashing continues, it means that the battery pack is faulty. Replace it with another one.
 - Use the High-Speed Charger Unit only to charge the lithium-ion battery packs specified for it.
 - A battery pack naturally discharges after it is charged. Because of this, you should use a battery pack as soon as possible after charging it.
 - This High-Speed Charger Unit is designed to automatically interrupt charging whenever ambient temperature is outside the range of 0°C to 40°C.
 - In order to ensure good speed charge results, keep the terminals of the High-Speed Charger Unit and battery pack clean by periodically wiping them off with a cotton swab or dry cloth.

DT-820CHGE High-Speed Charger Unit Specifications

Charger

Charger Type: Fixed voltage (with current limiter)
Charge Time: Approximately 2.5 hours

Power Supply

Method: Special AC adaptor
Current Consumption: Approximately 600mA

Dimensions and Weight

Dimensions: 68 (W) x 108 (D) x 35 (H) mm
Weight: Approximately 95g

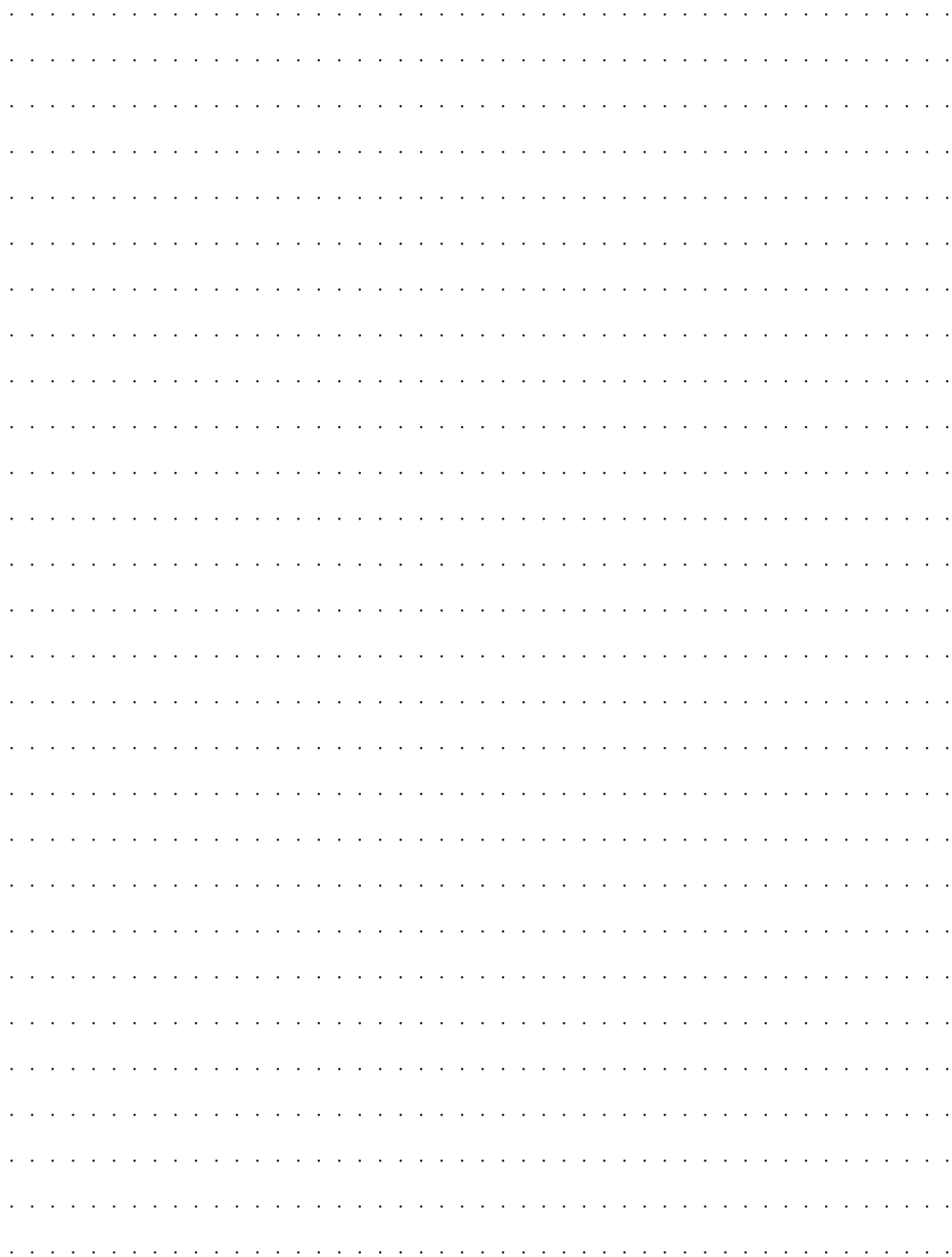

CASIO®